

C.R. 1037 ③

Pza. N° 02 25 100 000

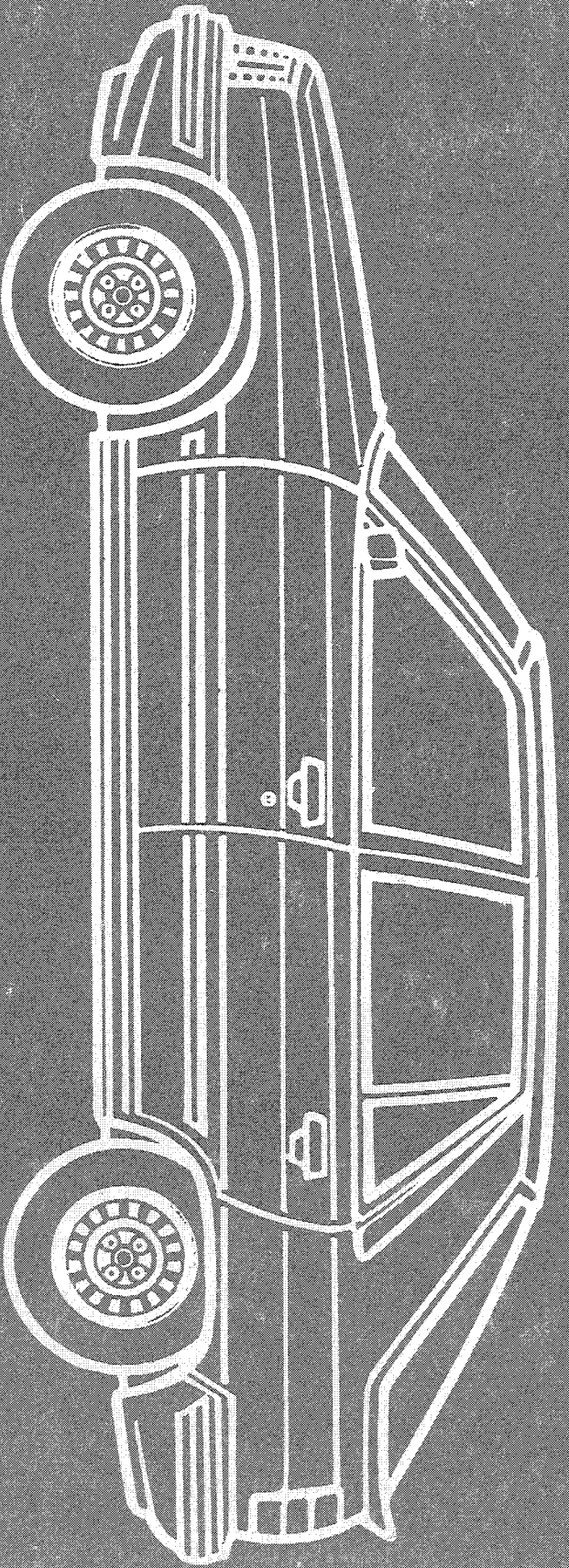

RENAULT 11 1984 ▾ □□□



01.02
C.R.1037

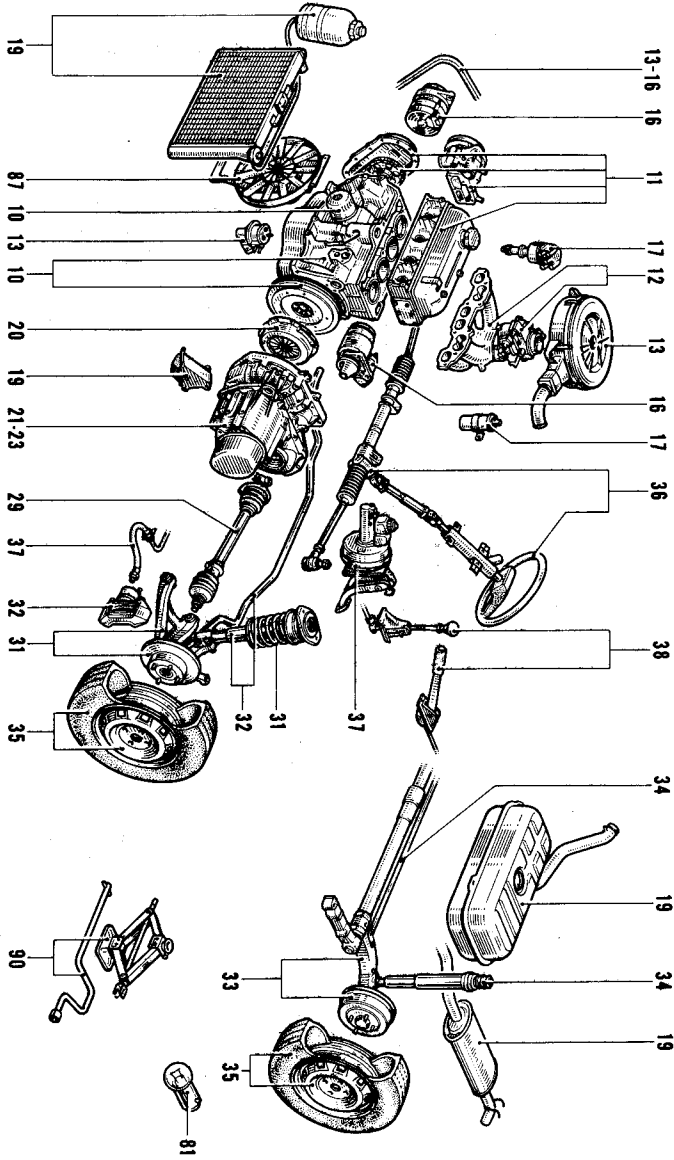

01.02
C.R.1037





01.03
C.R.1037

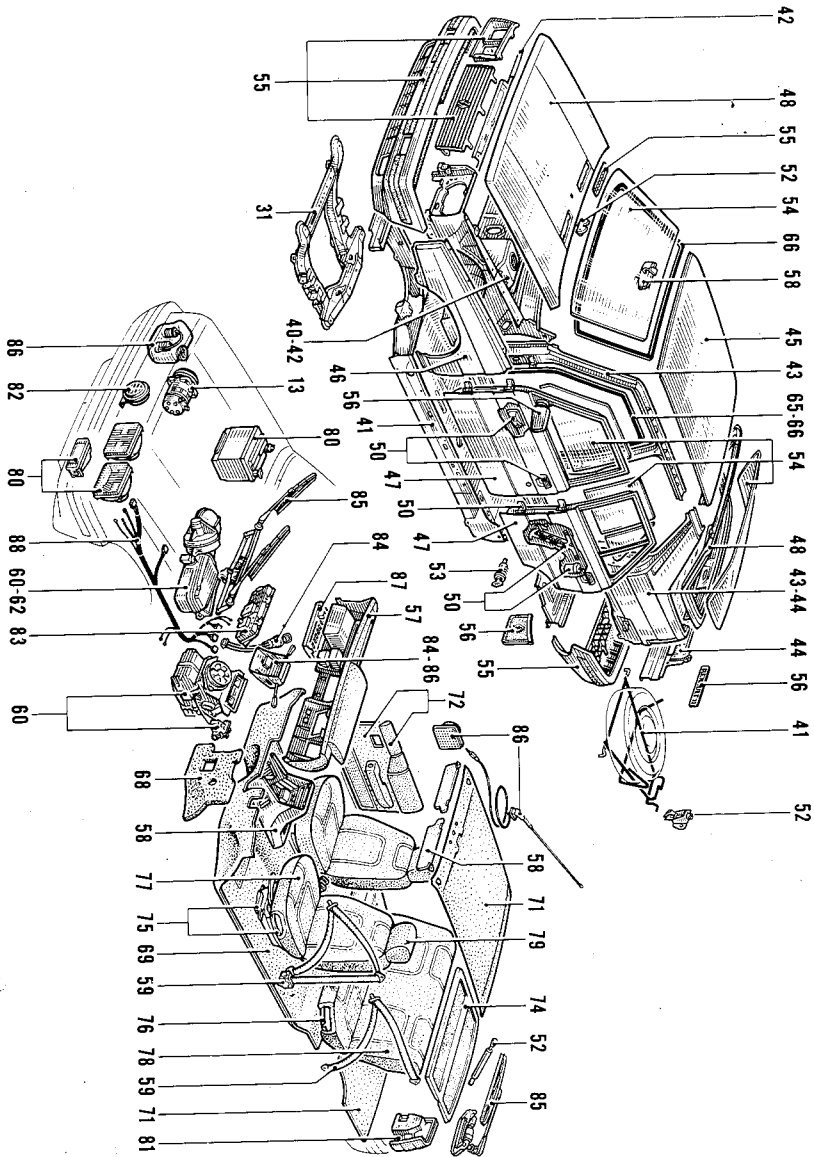

01.03
C.R.1037



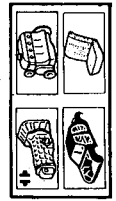

01.10

01.10

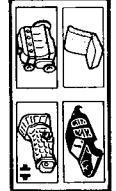

10.20

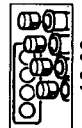

11.20-11.35

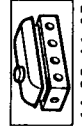

13.31



17.15

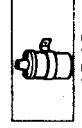

20.01

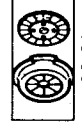

23.20-23.35



32.30-32.31



36.01-36.30



38.30



42.10

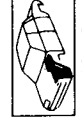

48.10

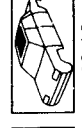

52.20



01.02-01.03

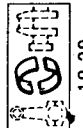

10.30



11.40-11.44



13.40-13.60

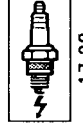

17.20

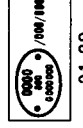

21.00

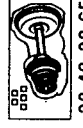

23.40-23.65



33.01



36.40

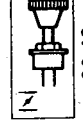

38.40



43.01



50.01

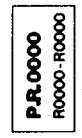

P.R.0000
R000-R000



10.40-10.45



12.01-12.05



13.85-13.87

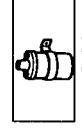

17.30



21.01-21.02



23.70



33.40



37.01-37.30



40.01



44.01



50.10-50.25

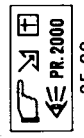

05.00



10.50-10.54



12.10-12.17



14.20-14.24

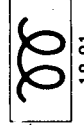

18.01



21.20-21.30



23.75-23.80

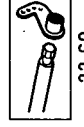

33.60

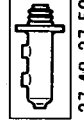

37.40-37.50



40.10



44.20



55.01-55.15

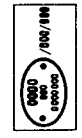

05.40

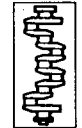

10.60-10.63



12.50-12.55



14.80



19.01-19.10



21.40-21.47



29.01

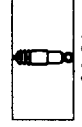

34.01



37.60



41.10

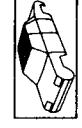

45.01



50.40-50.50



06.01-06.02

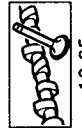

10.65



13.01-13.05



16.01-16.05



19.20



21.50

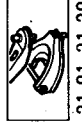

31.01-31.30

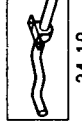

34.10

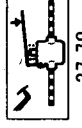

37.70

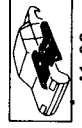

41.20

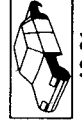

46.01



55.40

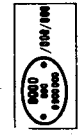

10.00



10.70-10.74



13.10-13.15

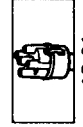

17.01



19.30-19.40



21.60-21.65



31.40

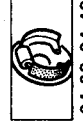

34.30-34.40



37.80



41.30



46.10



50.60



10.01-10.05



10.78



13.20-13.27

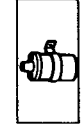

17.05



19.50-19.70

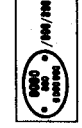

23.00

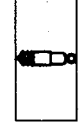

32.01



35.01



38.01



42.01



47.01



56.20-56.25

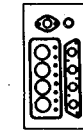

10.10-10.15



11.01-11.05



13.30



17.10



19.80



23.01



32.10



35.10

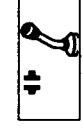

38.20

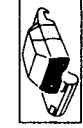

42.01-42.10



48.01



52.01



56.01



55.20-55.25



55.40



50.55



50.60

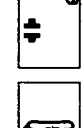

56.01



56.20-56.25



REVAU



48.01



52.01



56.01



01.11



01.11

56.30-56.35		60.10		74.01		81.40		84.30	
56.40		60.20-61.01		75.01		81.50		85.03-85.26	
57.01-57.10		62.30-62.35		75.10-75.11		82.01		86.01-86.10	
57.30		64.01-66.01		76.01-79.01		83.01-83.09		86.20	
58.20		68.01-69.01		79.10		83.10		86.30-86.35	
58.30		71.01		80.01		83.40		87.30-87.40	
58.40		71.05		80.20-80.30		84.01		87.50-87.52	
59.20-59.55		71.10-71.15		80.40-81.10		84.10		88.01-88.10	
59.80		72.01-72.20		81.20		84.20		90.01	

C.R.000
R0000-R0000

01.20
C.R.1037

C.R.000
R0000-R0000

01.20
C.R.1037

1	2	3	4	5	6	1990
7	8	9	10	11	12	

RENAULT 11 1984 ...

- B372
- B373
- B37E
- B37G
- B375
- B37T

C.R. 1037 **③**

02 25 100 000
Piezas de repuesto

Pièces de rechange

Spare parts

02.01

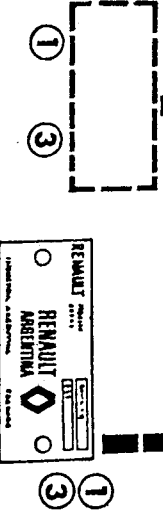
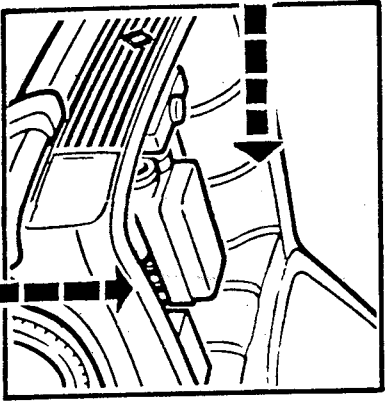
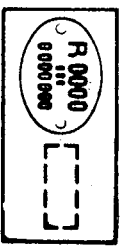

RENAULT ARGENTINA
SACD LICENCIA RNUA
MODELO / CARROC. / PAINT. / TAPIZ. / OBSER.
INDUSTRIA ARGENTINA

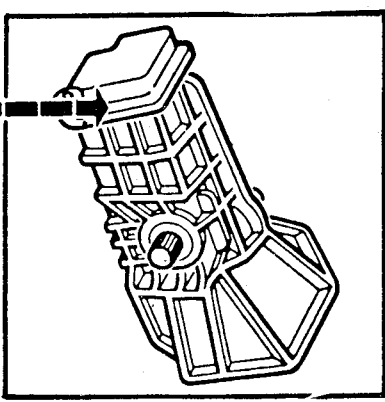
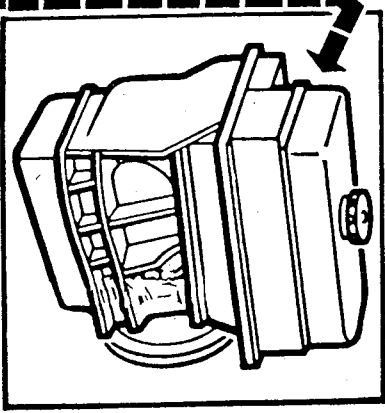



- 1
- 3
- 8
- 7

MODELO	Nº CARROC.	PINTURA	TAPIZADO
OPCIONAL		OBSERVACIONES	

2

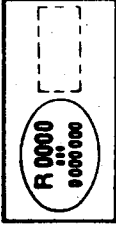
02.02



① R 0000 10... ② ③ ④ ⑤ ⑥
R 0000 10...  n° 0... 77 03 001 022 43.30
C.R.O

CASTELLANO

AL SOLICITAR PIEZAS DE REPUESTO,
SIRVANSE INDICAR:

- ① El modelo de vehículo.
- ② El número de su equipo extra costo.
- ③ El número de serie del vehículo.
- ④ El tipo y el número de fabricación del órgano.
- ⑤ El número de la pieza.
- ⑥ Facultativo el número del catálogo, el número de la lámina.
- ⑦ Número de código de tapizado.
- ⑧ Número de código de pintura.

FRANCAIS

POUR COMMANDER DES PIÈCES DE
RECHANGE, VEUILLEZ INDIQUER:

- ① Le type du véhicule.
- ② Le numéro de l'équipement.
- ③ Le numéro de fabrication du véhicule.
- ④ Le type et le numéro de fabrication de l'organe.
- ⑤ Le numéro de la pièce.
- ⑥ Facultatif: le numéro du catalogue, le numéro de la planche.
- ⑦ Numéro code garniture.
- ⑧ Numéro code peinture.

ENGLISH

WHEN ORDERING SPARE PARTS, WILL
YOU PLEASE MENTION:

- ① The vehicle type.
- ② The version number.
- ③ The vehicle fabrication number.
- ④ The unit type and fabrication number.
- ⑤ The part number.
- ⑥ And optionally: the catalogue number and page number.
- ⑦ Upholstery code number.
- ⑧ Paint code number.

INTRODUCCION

Este catálogo contiene todos los conjuntos y piezas sueltas vendidas como repuestos. En él, los números se encuentran con precisión y por medio de las láminas se los puede identificar con toda facilidad.

Estos conjuntos y piezas están distribuidos en láminas, según el sistema o el elemento del mismo al cual pertenecen.

Todas las láminas llevan un número de cuatro cifras, de los cuales, los dos primeros corresponden a la numeración codificada del sistema; cuando la lámina pueda confundirse con otras similares, lleva especificada la variante en cuestión o el número de serie del vehículo a partir del cual se incorporan las piezas mencionadas en la misma.

Una lámina se compone de:

La ilustración de las piezas o conjuntos del sistema detallado; a cada pieza ilustrada pueden corresponder uno o varios números de piezas que se diferencian entre ellos por una variante o bien por un símbolo codificado y, eventualmente, de cuadros de referencias en los que se mencionan informaciones complementarias, tales como el número de serie del vehículo a partir del cual se incorporan los cambios o algún dato dimensional. Estos cuadros figuran, ya sea debajo de la ilustración, o bien, en una página anexa a la ilustración.

Observación: el significado de los símbolos y expresiones codificadas utilizadas en cada lámina, están indicados en la lámina Nº 05.01...

Un índice ilustrado de las láminas, ubicado al comienzo del presente catálogo, indica debajo de cada figura representada, el número de la lámina que hoy que consultar.

Un índice numérico ubicado al final del catálogo, indica la correspondencia entre los números de piezas y los números de las láminas en que se muestran.

MODO DE EMPLEO

Determinación del número de una pieza, cuando se la reconoce físicamente:

1. **Buscar en el índice ilustrado,** la lámina correspondiente al sistema o elemento del sistema al que la pieza pueda pertenecer.
 2. **Consultar el Catálogo y buscar** la lámina, teniendo en cuenta las variantes precisas que pudieran existir o el número de serie del vehículo, según corresponda.
 3. **Una vez encontrada la lámina,** buscar el dibujo de la pieza deseada. A dicho dibujo puede corresponder uno o varios números de piezas, seleccionar entre ellos el que corresponda, teniendo en cuenta los símbolos o expresiones, codificadas indicadas en cada caso.
- Las citas numéricas o alfabéticas que acompañan el número de pieza sirven para vincularlo a los cuadros de referencias complementarios que se encuentran en la cara inferior de la lámina o en hoja anexa.
- Verificación de números de piezas** indicados en un pedido de repuestos redactado por un cliente, confeccionado en base a documentación que este posee:
1. **Buscar en el índice numérico,** el número de pieza indicado en el pedido, y determinar los números de las láminas correspondientes.
 2. **Consultar las láminas para comprobar** si el número de pieza es el que corresponde, teniendo en cuenta el número de serie del vehículo, o las variantes que pudieran existir en el sistema.
- Identificación por ilustraciones** de una pieza cuyo número se conoce:
1. **Buscar en el índice numérico** el número de pieza dado y determinar el número de la lámina en la cual está mostrada dicha pieza.
 2. **Consultar** estas láminas.

CONDICIONES GENERALES DE VENTA

Consultar la Lista de Precios de Repuestos y Accesorios Vigente a la fecha.

INTRODUCTION

Le présent document contient tous les ensembles et pièces détachées vendables en rechange; il permet de déterminer avec précision leurs numéros et de les identifier facilement par les illustrations.

Ces ensembles et ces pièces sont répartis par **planches** suivant l'organe ou l'élément d'organe auquel ils se rattachent.

Chaque **planche est identifiée** par un numéro à 4 chiffres dont les deux premiers correspondent à un code organe déterminé, elle peut être caractérisée par une variante ou un point de départ dans le cas où elle s'identifie avec une planche similaire.

Une planche se compose:

De l'illustration des pièces et ensembles de l'organe détaillé qui diffèrent de forme; à chaque pièce illustrée correspond un ou plusieurs numéros de pièces caractérisés entre eux par une variante ou un signe codifié et, éventuellement, de tableaux comportant des renseignements complémentaires tels que points de départ et consignes. Ces tableaux figurent soit en bas de l'illustration, soit sur une page annexe à l'illustration.

Remarque: la signification des signes et expressions codifiés utilisés dans chaque planche, est indiquée dans la planche n° 05.01...

Un **répertoire des planches** illustré indique sous chaque vignette représentée le numéro de planche à consulter.

Un **répertoire numérique** en fin de catalogue donne la correspondance entre les numéros de pièces et les numéros de planches ainsi que les quantités de pièces par véhicule dans la planche considérée.

Le document "P.R. 830 Renault" donne les caractéristiques des numéros de la boulonnerie normalisée.

UTILISATION

Détermination du numéro d'une pièce connaissant la nature de celle-ci:

1. Rechercher dans le **répertoire des planches** la planche correspondant à l'organe ou l'élément d'organe auquel cette pièce peut se rattacher.
2. Consulter le catalogue pour y retrouver cette planche en tenant compte éventuellement du point de départ ou de la variante caractérisant la planche.
3. La planche étant déterminée, rechercher l'illustration de la pièce désirée. A cette illustration correspond un ou plusieurs numéros. Choisir celui qui convient, compte tenu des signes ou expressions codifiés les caractérisant.

Les renvois numériques ou alphabétiques affectés aux numéros de pièces assurent la liaison entre ces numéros et les renseignements complémentaires contenus dans les tableaux situés soit en bas de l'illustration soit en page annexe.

Vérification, par les Succursales, Concessionnaires ou Centres Importateurs, d'un **bon de commande**, rédigé par un Agent ou un client ayant utilisé la documentation en sa possession.

1. Rechercher dans le **répertoire numérique**, au numéro de pièce donné par le bon de commande, les numéros de planches correspondantes.

2. Consulter ces planches pour vérifier si le numéro de pièce est bien celui qui convient compte tenu des points de départ affectés à ce numéro et au numéro de véhicule ou d'organe pour lequel la pièce est commandée.

Identification par l'illustration d'une pièce dont on connaît le numéro.

1. Rechercher dans le répertoire numérique, au numéro de pièce donné, le numéro des planches correspondantes.
2. Consulter ces planches.

CONDITIONS GÉNÉRALES DE VENTE

Voir les tarifs de pièces de rechange.

INTRODUCTION

This document contains all the assemblies and parts sold as spares; it enables one to determine with precision their numbers and to identify them easily by the illustrations.

These assemblies and these parts are set out in **illustrated plates** according to the unit or subassembly to which they belong.

Each **plate is identified** by a four figure number; the first two of which correspond to a specified unit code; it may be distinguished by a variant or a starting point in the case where it is identifiable with a similar plate.

A plate consists of:

The illustration of parts and assemblies of the unit shown which differ in shape; one or several numbers correspond to each part illustrated and these are distinguished one from the other by a variant or symbol and if necessary **tables** showing additional information such as starting points and instructions. These tables are found on the bottom of the illustration or on a page added to the illustration.

Note: the meanings of the symbols and coded expressions used on each plate are listed on Plate No 05.01...

A list of **illustrated plates** gives the Plate Number to refer to under each square.

A **numerical index** at the end of the catalogue gives the relationship between the part numbers and the plate numbers also the parts quantity required per vehicle in the plate concerned.

The "Renault - P.R. 830" catalogue gives the specifications for all the standard bolt part numbers)

USE

As certaining a part Number knowing the nature of this part:

1. In the **plate index**, find the plate corresponding to the unit or sub-assembly to which this part may be attached.
2. Consult the catalogue to find this plate, when necessary taking into account the starting point or the variant distinguishing this plate.
3. Having found the plate, look for the illustration of the desired part. One or several numbers correspond to this illustration; choose the suitable number, taking into account code signs or expressions which distinguish them.

The numerical or alphabetical reference marks added to the part number, ensure the connection between these numbers and the additional information appertaining to them, included in the tables found at the bottom of the illustration or on the additional page.

Checking by Branches, Distributors or Importation Centres of an **Order Form** which has been filled in by an Agent or by a client using the documents in his possession.

1. In the **numerical index**, at the part number indicated on the order form, find the corresponding plate numbers.

2. Examine these plates to check that the part number given is correct taking into account the starting points added to this number and the number of the vehicle or unit for which the part has been ordered.

Identifying by the illustration a part the number of which is known.

1. In the numerical index, at the given part number find the corresponding plate numbers
2. Consult these plates.

GENERAL SALES CONDITIONS

See the spare parts price lists.

05.01

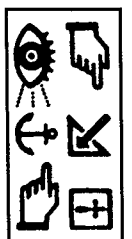

CASTELLANO

FRANCAIS

ENGLISH



Vehículo

Véhicule

Vehicle



Grupo motriz

Groupe

Power unit



Motor

Moteur

Engine



Caja puente o caja de cambios

Boîte pont ou boîte de vitesse

Gearbox-transmission or gearbox



Pieza que hay que agotar

Pièce à épuiser

Use up stock



Una vez agotada reemplazar por

Après épuisement, prévoir

After exhaustion of stock, supply



Instrucciones para la
intercambialidad simbolizadas por

Consignes d'interchangeabilité

Interchangeability instructions
symbolizes by



Piezas suplementarias a proveer

Pièces à prévoir en supplément

Supplementary parts to be foreseen



Para

Pour

For



Excepto

Sauf

Except









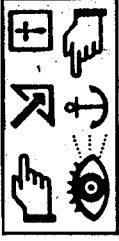

... a ...

... a ...

... to ...









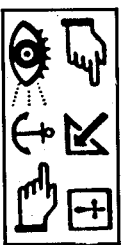



05.02

	Dirección a la izquierda	Direction à gauche	L. H. drive
	Dirección a la derecha	Direction à droite	R. H. drive
<input type="checkbox"/>	Equipo opcional	Equipement facultatif	Optional equipment
	Motor Diesel	Moteur Diesel	Diesel engine
	Motor a nafta	Moteur à essence	Carburetor engine
	Vidriado	Vitrée	Windowed
	Cerrado	Tôlée	Closed
	Con servofreno	Avec freinage assisté	With booster brake
	Sin servofreno	Sans freinage assisté	Without booster brake
	Piezas vendidas por cantidad determinada	Pièces vendues en quantité déterminée	Parts sold in a fixed quantity
#	Indica que se trata de un número de pieza de aplicación provisoria	Indique qu'il s'agit d'un chiffre provisionnel d'application	Indicates that this concerns a provisional application number
&	Y	Et	And

05.03



	Ver lámina o ver página	Voir planche ou voir page	"See plate" or "see page"
	0,00 Unidad de venta	Unité de vente	Sold in following quantities
	0,00 Venta a la longitud de fabricación	Vente en longueur de fabrication	Sold in manufactured length
	O bien	Ou bien	Or
%	Condiciones especiales de cambio	Conditions spéciales d'échange	Special conditions for replacement
	Ubicación de la marca en el conjunto o en la pieza	Emplacement du marquage sur l'ensemble ou la pièce	Position of the marking on the assembly or the part
	Piezas vendidas por colecciones bajo un solo número	Pièces vendues en collection sous un seul numéro	Parts sold as a kit under one par number
	Caja de cambios	Boîte de vitesses	Gearbox
	Caja puente o caja de cambios con mandos en tablero	Boîte-pon ou boîte de vitesses avec commandes a la planche de bord	Gearbox-transmission or gearbox with dashboard mounted gear shift
	Caja puente o caja de cambios con mandos en el piso	Boîte-pont ou boîte de vitesses avec commandes au plancher	Gearbox-transmission or gearbox with floor mounted gear shift
	3 velocidades	3 vitesses	3 speed
	4 velocidades	4 vitesses	4 speed



05.04

5U	5 velocidades	5 vitesses	5 speed
1	1ª velocidad	1 vitesse	1st. speed
2	2ª velocidad	2 vitesse	2nd. speed
3	3ª velocidad	3 vitesse	3rd. speed
4	4ª velocidad	4 vitesse	4th. speed
5	5ª velocidad	5 vitesse	5th. speed
1-2	1ª y 2ª velocidades	1 et 2 vitesses	1st. and 2nd. speeds
2-3	2ª y 3ª velocidades	2 et 3 vitesses	2nd. and 3rd. speeds
3-4	3ª y 4ª velocidades	3 et 4 vitesses	3rd. and 4th. speeds
4-5	4ª y 5ª velocidades	4 et 5 vitesses	4th. and 5th. speeds
R	Marcha atrás	Marche arrière	Reverse
1R	1ª velocidad - Marcha atrás	1 vitesse - Marche arrière	1st. speed - Reverse

05.05

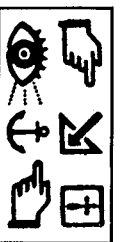

Número de dientes

Nombre de dents

Number of teeth



Dentado exterior: número de dientes
(ejemplo: 10 dientes)

Denture extérieure: nombre de dents
(exemple: 10 dents)

External teeth: number of teeth
(for example: 10 teeth)



Dentado interior: número de dientes
(ejemplo: 10 dientes)

Denture intérieure: nombre de dents
(exemple: 10 dents)

Internal teeth: number of teeth
(for example: 10 teeth)



Admisión

Admission

Inlet



Escape

Echappement

Exhaust



Luz de cruce

Feu de croisement

Anti-clare light



Proyector de larga alcance

Projecteur longue portée

Long range driving light



Vehículo con transmisión mecánica

Véhicule à transmission mécanique

Vehicle with manual shift gearbox



Vehículo con transmisión automática

Véhicule à transmission automatique

Vehicle with automatic transmission



Distancia entre ejes en decímetros (dm)

Empattement exprimé en décimètres (dm)

Wheelbase expressed in decimetres (dm)



Levantavidrio mecánico

Lève-vitre mécanique

Mechanical window lifter















Levantavidrio eléctrico

Lève-vitre électrique

Electric window lifter

05.06



	Ordenador de a bordo	Ordinateur de bord	Board ordinator
	Electrónico	Electronic	Electronic
	No electrónico	Non électronique	Mechanic
	Piezas a pintar	Pièces à peindre	Piece to paint
	Carga útil indicada en kilogramos (kg)	Charge utile indiquée en kilogrammes (kg)	Load marked in kilograms (kg)
	Traba levantavidrios	Interdiction lève-vitre A.R.	Window stop
	Acondicionador de aire	Climatiseur	Air aconditioner
	Frenos con aproximación automática de zapatas	Freins avec rattrapage automatique d'usure	Brakes with self-adjusting mechanism
	Frenos sin aproximación automática de zapatas	Freins sans rattrapage automatique d'usure	Brakes with manual adjustment
	Vehículo con aire acondicionado	Véhicule avec conditionnement d'air	Vehicle with air conditioning
	Vehículo sin aire acondicionado	Véhiculo sans conditionnement d'air	Vehicle without air conditioning
	Con enclavamiento electromagnético de las cerraduras de las puertas	Avec condamnation électromagnétique des serrures de portes	With electro-magnetic door locking mechanism

05.07

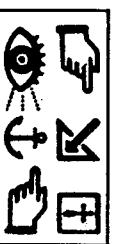

Sin enclavamiento electromagnético de las cerraduras de las puertas

Sans condamnation electro-magnétique des serrures de portes

Without electro-magnetic door locking mechanism



Vehículo con servo-dirección

Véhicule avec servo-direction

Vehicle with power assisted steering



Vehículo sin servo-dirección

Véhicule sans servo-direction

Vehicle without power assisted steering



Vidrios incoloros

Vitres incolores

Clear glass



Vidrios polarizados

Vitres teintées

Tinted glass



Desempañador de luneta trasera

Desembuage lunette arrière

Rear screen demistint



Acero

Acier

Steel



Latón

Laiton

Brass



Cobre

Cuivre

Copper



Niñón

Nylon

Nylon



Acero inoxidable

Acier inoxydable

Stainless steel



Aluminio

Aluminium

Aluminium



05.08

7	Tapizado simil-cuero	Sellerie simili	Leathercloth upholstery
8	Tapizado paño	Sellerie tissu	Cloth upholstery
9	Percal	Percalé	Coated cambric muslin
10	Alfombrilla	Moquette	Carpeting
11	Fieltro	Feutre	Felt
12	Lona para toldo	Toile a bache	Tilt canvas
13	Tapizado cuero	Sellerie cuir	Leather upholstery
14	Fundición	Fonte	Cast
15	Caucho	Caoutchoue	Rubber
16	Boucle	Bouclée	Boucle
[]	Señal color	Repere couleur	Colour mark
[1]	Plateado	Chrome	Chrome

05.09

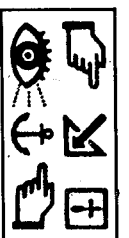

[2] Dorado

Or

Gold

[3] Blanco

Blanc

White

[4] Gris intermedio

Gris moyen

Medium grey

[5] Negro

Noir

Black

[6] Azul

Bleu moyen

Medium blue

[7] Azul claro

Bleu clair

Light blue

[8] Verde

Vert moyen

Medium green

[9] Verde claro

Vert clair

Light green

[10] Verde oliva

Vert olive

Olive green

[11] Amarillo

Jaune

Yellow

[12] Naranja

Orange

Orange

[13] Marrón oscuro

Marron foncé

Dark maroon



05.10

[14]	Marrón claro	Marron clair	Light maroon
[15]	Beige intermedio	Beige moyen	Medium beige
[16]	Rojo intermedio	Rouge moyen	Medium red
[17]	Rosa	Rose	Pink
[18]	Violeta	Violet	Violet
[19]	Lila	Mauve	Mauve
[20]	Rojo oscuro	Rouge foncé	Dark red
[21]	Gris claro	Gris clair	Light grey
[22]	Gris oscuro	Gris foncé	Dark grey
[23]	Beige claro	Beige clair	Light beige
[24]	Beige oscuro	Beige foncé	Dark beige
[25]	Marrón intermedio	Marron moyen	Medium maroon

05.11

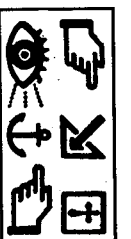

 Crema

Crème

Cream

 Marfil

Ivoire

Ivory

 Sepia

Sépia

Sepia

4x2 Vehículo con 2 ruedas motrices

Véhicules 2 roues motrices

2 driving wheel vehicle

4x4 Vehículo con 4 ruedas motrices

Véhicules 4 roues motrices

4 driving wheel vehicle

 Sintetizador de palabras

Synthétiseur de parole

Words synthesiser

 Comando de radio

Commande radio

Radio remote control

 Temporizador

Temporisateur

Temporized

 Nivel de agua

Niveau eau moteur

Water level

 Nivel del aceite

Niveau d'huile

Oil level

 Presión del aceite

Pression d'huile

Oil pressure







 Temperatura del aceite

Température d'huile

Oil temperature



05.12

	Pre calentador diesel	Préchauffage diesel	Diesel pre-heather
	Parcializador (todos los tipos) puesta a cero	RAZ (tous types) remise à zéro	RAZ (all types) zero return
	Reóstato (todos los tipos)	Rhéostat (tous types)	Rheostat (all types)
	Filtro de gasoil	Filtre à gazole	Gas oil filter
	Economizador	Economètre	Econometer
	Taquímetro	Tachygraphe	Taquistograph
	Combustible	Carburant	Fuel
	Antipolución	Antipollution	Antipollution
	Alarma sonora	Alarme sonore	Acoustic alarm
	Contactador de prueba 3 testigos	Contacteur test 3 témoins	Test contactor witness
	Levantavidrio eléctrico	Lève-vitre électrique	Electric window lifter
	Levantavidrio manual	Lève-vitre impulsion	Mechanical window lifter

05.13

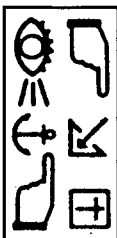

(Abs) Con antibloqueo de ruedas

Avec anti-blocage des roues

With wheels anti-blockade

(N) Sin antibloqueo de ruedas

Sans anti-blocage des roues

Without wheels anti-blockade



Techo corredizo eléctrico

Toit ouvrant électrique

Electric sliding roof cover



Parabrisas laminado

Pare-brise feuilleté

Laminated windshield



Parabrisas templado

Pare brise trempé

Toughened windshield



Luz de marcha atrás

Phare de recul

Back up light



Proyector regulable

Réglage projecteur

Adjusting light



Luz antiniebla

Feu brouillard avant

Anti-fog light



Plafón

Plafonnier seul

Ceiling lamp



Luz antiniebla trasera

Feu brouillard arrière

Rear anti-fog light



Luz spot

Plafonnier spot

Ceiling light















Iluminación

Eclairage

Illumination









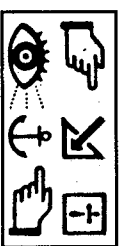



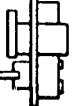

05.14

	Volante de altura regulable	Volant réglable en hauteur	Height regulated driving wheel
	Estrangulador de aire para el arranque	Volet de départ	Starting shutter
	Encendedor de cigarrillos	Allume-cigares	Cigarettes lighter
	Detector de temperatura exterior	Détecteur de température extérieure	Outside thermometer
	Indicador de giro	Indicateur direction	Course indicator
	Arranque	Démarrage	Starter
	Limpia-lavafaros	Essuie & lave phare-combiné	Light cleaner combination
	Lavaparabrisas	Lave-vitre	Glass washer
	Limpia-lavaparabrisas	Essuie & lave vitre-combiné	Glass cleaner and whipper combination
	Nivel de agua de lavaparabrisas	Niveau lave-vitre	Glass washer level
	Limpiaparabrisas	Essuie-vitre	Whipper
	Indicador de carga	Indicateur de charge	Charge indicator

05.15



	Luz de emergencia	Signal de détresse	Distress signal
	Bocina	Avertisseur	Horn
	Cinturón de seguridad	Ceinture sécurité	Security belt
	Desempañador	Désembuage	Dermister screen
	Indicador de fallas de filamentos	Défil	Filaments failure indicator
	Traba electromagnética central	Verrouillage central electro-magnétique	Electromagnetic central locking device
	Carburador	Carburateur	Carburetor
	Indicador de freno de mano	Témoin frein à main	Hand brake witness
	Indicador de desgaste de pastillas de freno	Témoin usure plaquettes	Brake wear witness
	Indicador de desgaste de zapatas de freno	Témoin nivocode usure plaquettes	Plate wearing witness
	Remolque	Remorque	Trailer
	Temperatura de agua	Temperature d'eau	Water temperature









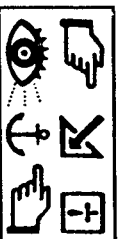



05.16



1/	Respaldo fijo	Dossier fixe	Fixed seat back
2/	Respaldo regulable	Dossier réglable	Adjustable seat back
3/	Respaldo inclinable (asiento transformable en cama)	Dossier inclinable (couchette)	Reclining seat back (travel bed)
4/	Banqueta delantera	Banquette avant	Front bench seat
5/	Asientos delanteros separables	Sièges avant séparés	Separate front seats
6/	Respaldo rebatible	Dossier rabattable vers l'avant	Revolving seat back
7/	Asientos separados de respaldo fijo tipo microómnibus	Sièges séparés type microcar à dossier fixe	Separated seats with fixed seat back
8/	Butaca delantera basculante de respaldo fijo	Banquette avant basculante dossier fixe	Pivoting fixed front seat
9/	Asiento 2 plazas basculante con respaldo rebatible	Banquette 2 places basculante dossier rabattable	2 places seat pivoting seat back
A/	Asiento de altura regulable	Siège réglable en hauteur	High regulated seat
B/	Asiento de conductor fijo	Siège "captain chair" socle fixe	"Captain chair" seat fixed platform
C/	Asiento de conductor reclinable	Siège "captain chair" socle pivotant	"Captain chair" seat pivoting platform

05.17



	Asiento trasero basculante con respaldo rebatible	Banquette AR basculante, dossier rabattable	Pivoting back seat
	Versión sin desempañado eléctrico de la luneta trasera	Version sans désembuage électrique lunette arrière	Version without electric rear window demister
	Furgón sin cristales techo normal	Fourgon tôle toit normal	Plain-sided van with normal roof
	Techo sobreelevado	Pavillon surélevé	High roof van
	Furgón mixto techo normal	Fourgon mixte toit normal	Universal van with normal roof
	Microbús 8/9 plazas con techo sobreelevado	Fourgon mixte - Microcar 8/9 places toit surélevé	Universal van elevated roof
	Furgón acristalado techo normal 8/9 plazas	Fourgon vitré - Microbus 9 places Tourisme 8 places toit normal	Van with side windows and normal roof
	Furgón acristalado 12 plazas techo sobreelevado	Fourgon vitré - Microcar 12 places toit surélevé	Window van microcar 12 seats elevated roof
	Carrocería de largo normal	Plateau cabine standard	Cab standard floor
	Carrocería larga	Plateau cabine allongé	Cab elongated floor
	Piso cabina	Plancher cabine - Chassis cabine	Cab floor panel
	Puerta lateral corrediza	Porte latérale coulissante	Sliding side door

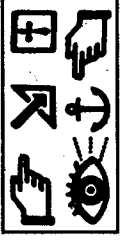

05.18

Hinged side door

Porte latérale battante

Puerta lateral vaivén



Hinged rear door

Porte arrière battante

Puerta trasera de vaivén



Standard roof version

Version toit normal

Versión techo normal



Sonroof version

Version toit ouvrant

Versión techo corredizo



Platform only

Pick-up

Plataforma desnuda



Chassis

Châssis

Chasis



Front wheel drive

Véhicule à traction

Vehículo de tracción



Rear wheel drive

Véhicule à propulsion

Vehículo de propulsión



Van - all types

Fourgon tous types

Furgoneta todos tipos



Platform trucks - all types

Transports ouverts tous types

Transportes abiertos todos tipos



Truck

Benne

Vehículo con caja



Plain-sided van with normal roof .













Fourgon tôle pavillon normal

Furgón sin cristales techo normal



05.19



	Furgón con el techo superalio	Fourgon tôle pavillon surélevé	High roof van
	Microbús con el techo normal	Microcar à pavillon normal	Standard roof bus
	Ambulancia	Ambulance	Ambulance
	Furgón con puerta corrediza enchapada y puertas traseras de vaivén	Fourgon à porte coulissante tôle	Van with sliding side door and hinged rear doors
	Furgón con puerta lateral corrediza acristalada y puertas traseras de vaivén	Fourgon à porte coulissante vitrée	Van with sliding side door and window and hinged rear doors
	Furgón con puerta lateral vaivén	Fourgon à porte battante tôle	Closed hinged door van
	Furgón puerta lateral corrediza enchapada con portón	Fourgon à porte coulissante tôle avec hayon arrière	Van with plain sliding side door and tailgate
	Furgón puerta lateral corrediza acristalada con portón	Fourgon à porte coulissante vitrée avec hayon arrière	Van with sliding side door and window and tailgate
	Furgón puerta lateral vaivén con portón	Fourgon à porte battante tôle avec hayon arrière	Covered revolving door van with detachable rear cover
	Furgón puerta lateral vaivén acristalada con portón.	Fourgon à porte battante vitrée avec hayon arrière	Glassed revolving door van with detachable rear cover
	Furgón sin puerta lateral, con puerta trasera de vaivén	Fourgon sans porte latérale avec portes battantes arrière	Van with plain sides and hinged rear door
	Furgón sin puerta lateral con portón.	Fourgon sans porte latérale avec hayon arrière	Van without side door but with rear cover

05.20



Vehículo con techo ventilado

Véhicule avec trappe d'aération

Ventilated covered vehicle



Vehículo sin techo ventilado

Véhicule sans trappe d'aération

Vehicle without ventilation cover

MOD

Seguido del año comercial, indica el año del modelo en espera de las cifras de aplicación

Suivi du millésime, indique l'année du modelo en attente des chiffres d'application

Followed by year of manufacture indicates model year pending issue of application numbers

T

Código de tapizado

Code couleur garniture

Upholstery colour code

A

Amperio

Ampère

Ampere

V

Voltios

Volts

Volts

W

Watio

Watt

Watt



10.01
C.R.1037

- 1 - 77 02 080 626 (a)
- 2 - 77 02 080 634 (b)
- 77 02 080 636 (b)
- 3 - 77 02 080 728 (B-375)
- 4 - 77 02 080 866
- 77 02 080 867

- (a) / B372
- (b) / B373
- (c) / B37T

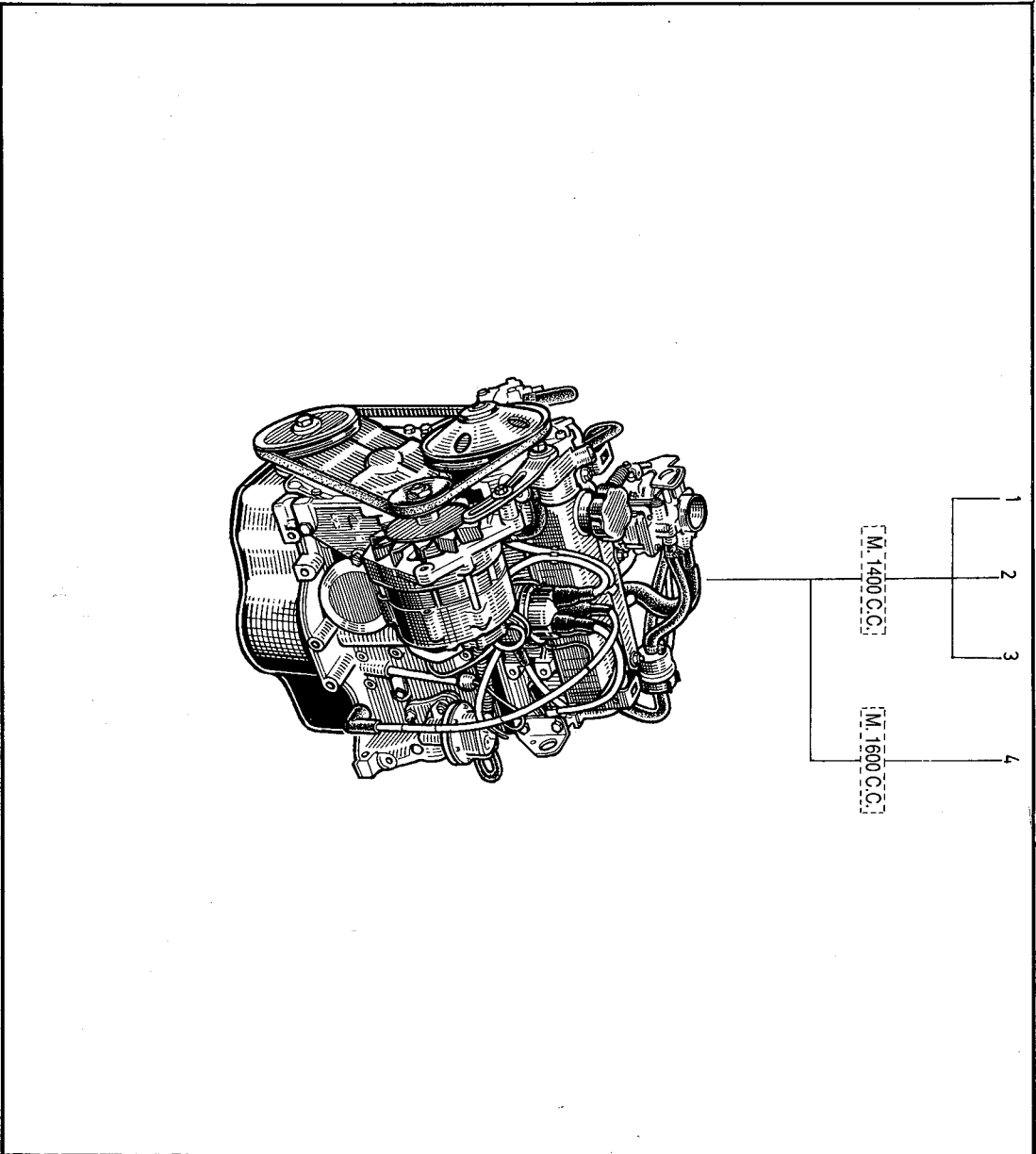

10.01
C.R.1037



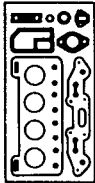

10.10
C.R.1037

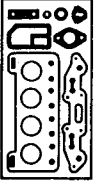

10.10
C.R.1037

- 1 - 77 02 088 733 (B - 375)
- 77 02 073 700
- 2 - 77 02 070 195
- 77 02 206 018 (a)
- 3 - 77 02 089 542
- 77 02 089 543 (B - 375)
- 77 02 206 017 (a)

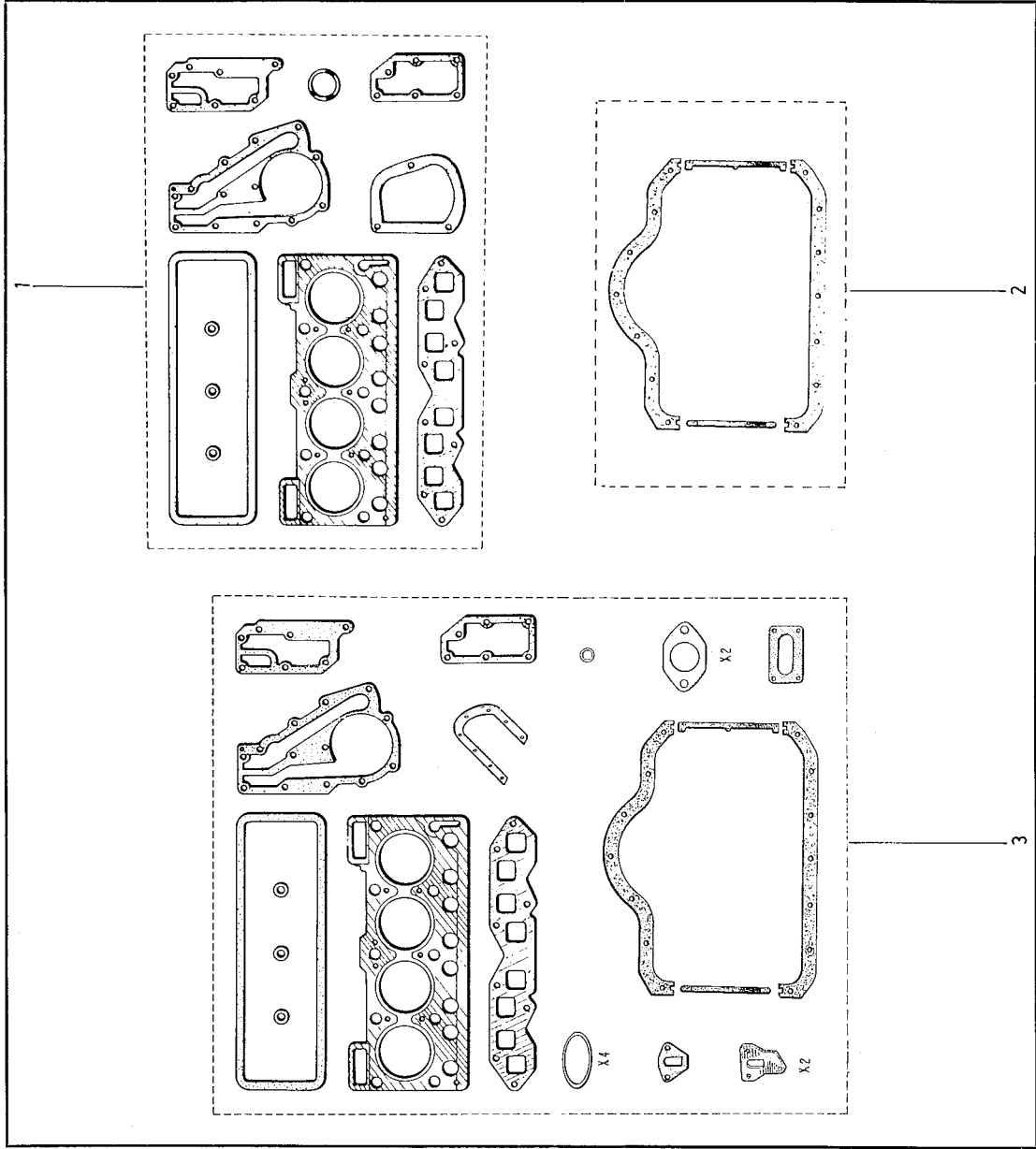

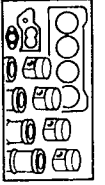

10.20
C.R.1037

- 1- 77 02 088 734 (B-375) + (37)
- 77 02 073 701 + (36)
- 2- 77 02 070 229
- 77 02 088 731 (B-375)
- 3- 77 02 070 269
- 77 02 088 732 (B-375)
- 77 02 206 015 (A)

(a) / B37T

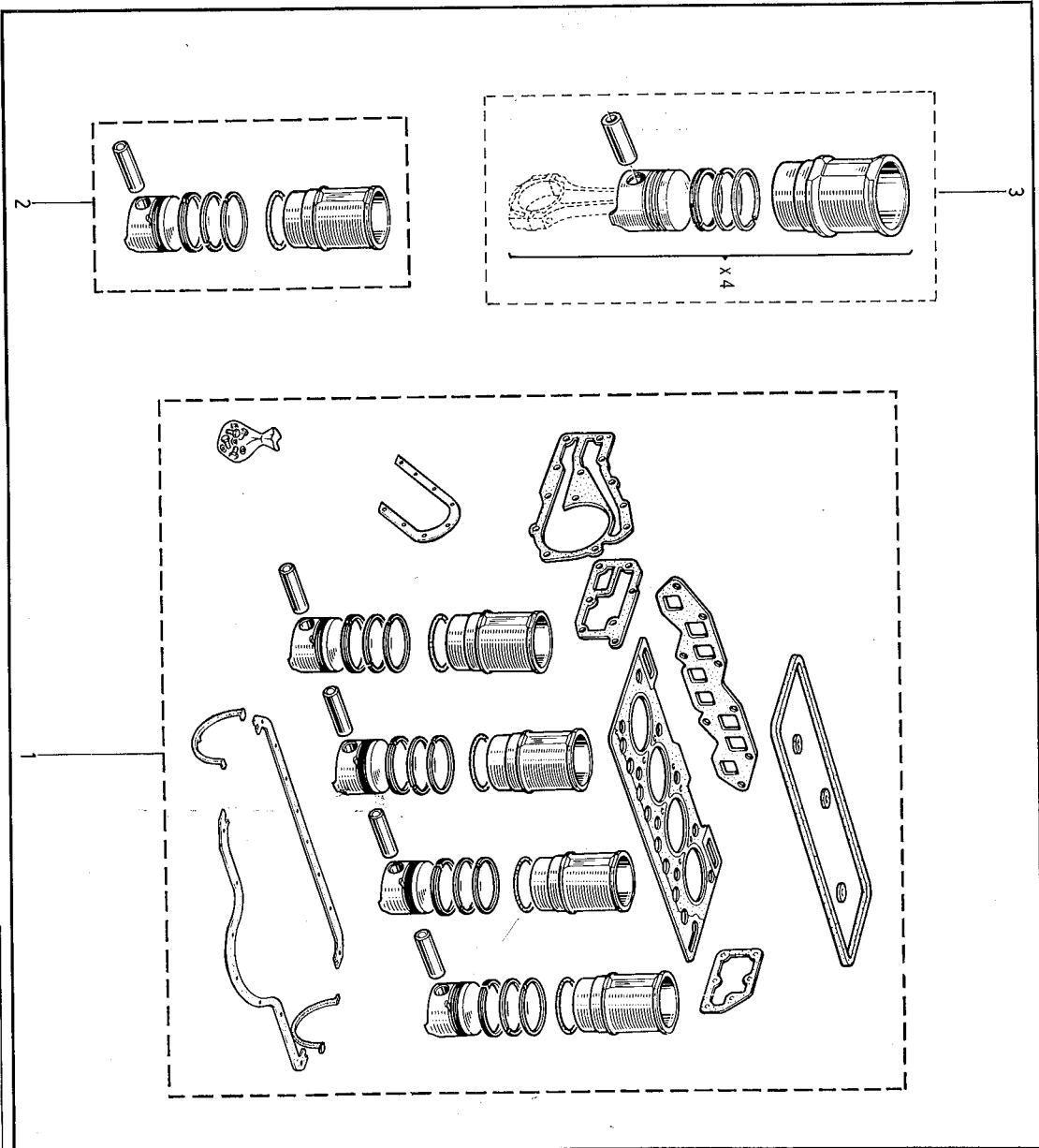

10.20
C.R.1037

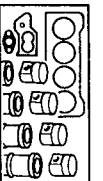

- (36) □ 77 02 070 269 -1
- ⊕ 77 02 089 542 -1
- (37) □ 77 02 088 732 -1
- ⊕ 77 02 089 543 -1

10.30
C.R.1037

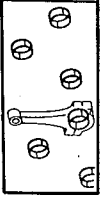

- 1 - 77 02 070 140 (x = 54,80)
- 77 02 070 141 (x = 54,79)
- 77 02 070 142 (x = 54,55)
- 77 02 070 165 (x = 54,30)
- 77 01 348 419 (x = 54,80)
- 77 01 348 420 (x = 54,65)
- 2 - 77 02 070 166 (x = 2,85)
- 77 02 070 167 (x = 2,90)
- 77 02 070 168 (x = 2,95)
- 77 02 070 169 (x = 3,00)
- 3 - 77 01 348 416 (x = 43,75)
- 77 01 348 415 (x = 44)
- 1018416 (x = 44)
- 1018417 (x = 43,75)
- 77 02 052 142 (x = 43,5)
- 77 02 052 143 (x = 43,25)

10.30
C.R.1037

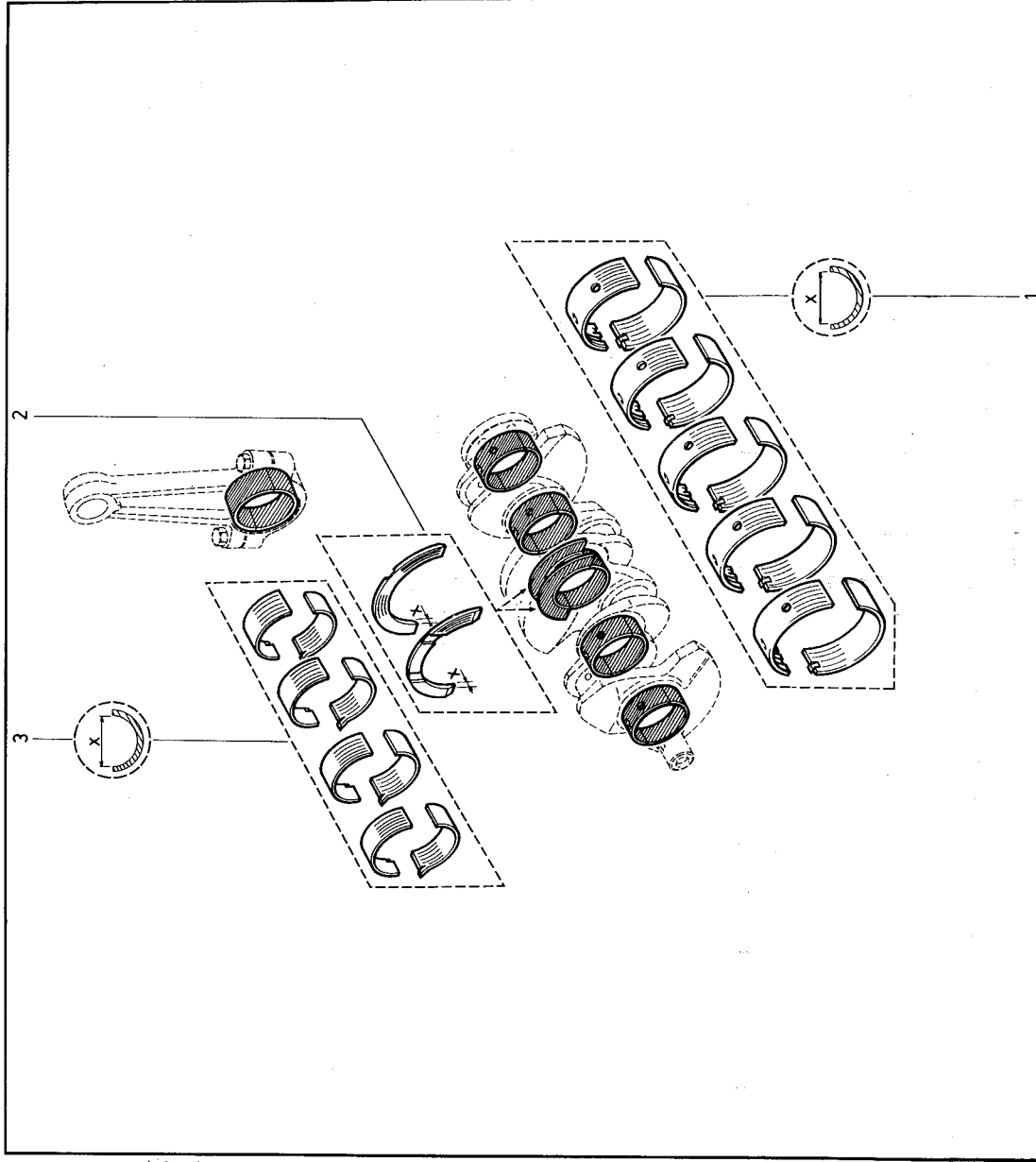
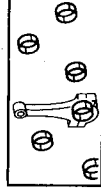



10.40

C.R.1037

- 1 - 77 02 206 045 (a)
- 77 02 073 702 +
- 77 02 206 159 (85)
- 2 - 77 05 010 006
- 3 - 77 00 567 740
- 4 - 77 03 082 015
- 5 - 77 03 027 112
- 6 - 77 03 075 091
- 7 - 77 02 056 319
- 8 - 77 03 075 009
- 9 - 77 05 010 056
- 10 - 77 03 087 080
- 77 02 086 462
- 11 - 77 01 348 178
- 77 00 639 573 (a)
- 77 00 642 113 (a)
- 12 - 07 06 329 400
- 13 - 77 00 724 120 +
- 77 00 729 282
- 14 - 77 03 101 172 (x = 32)
- 77 03 001 186 (x = 35)
- 15 - 77 03 055 013
- 16 - 79 03 053 050
- 17 - 77 00 680 351
- 18 - 77 03 027 120
- 19 - 08 57 538 200
- 20 - 77 02 057 895 (B-375)
- 21 - 77 00 701 902 (B-375)
- 22 - 77 03 055 011
- 23 - 79 03 032 018
- 24 - 79 03 053 043

(a) / B37T

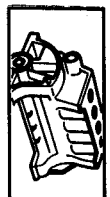
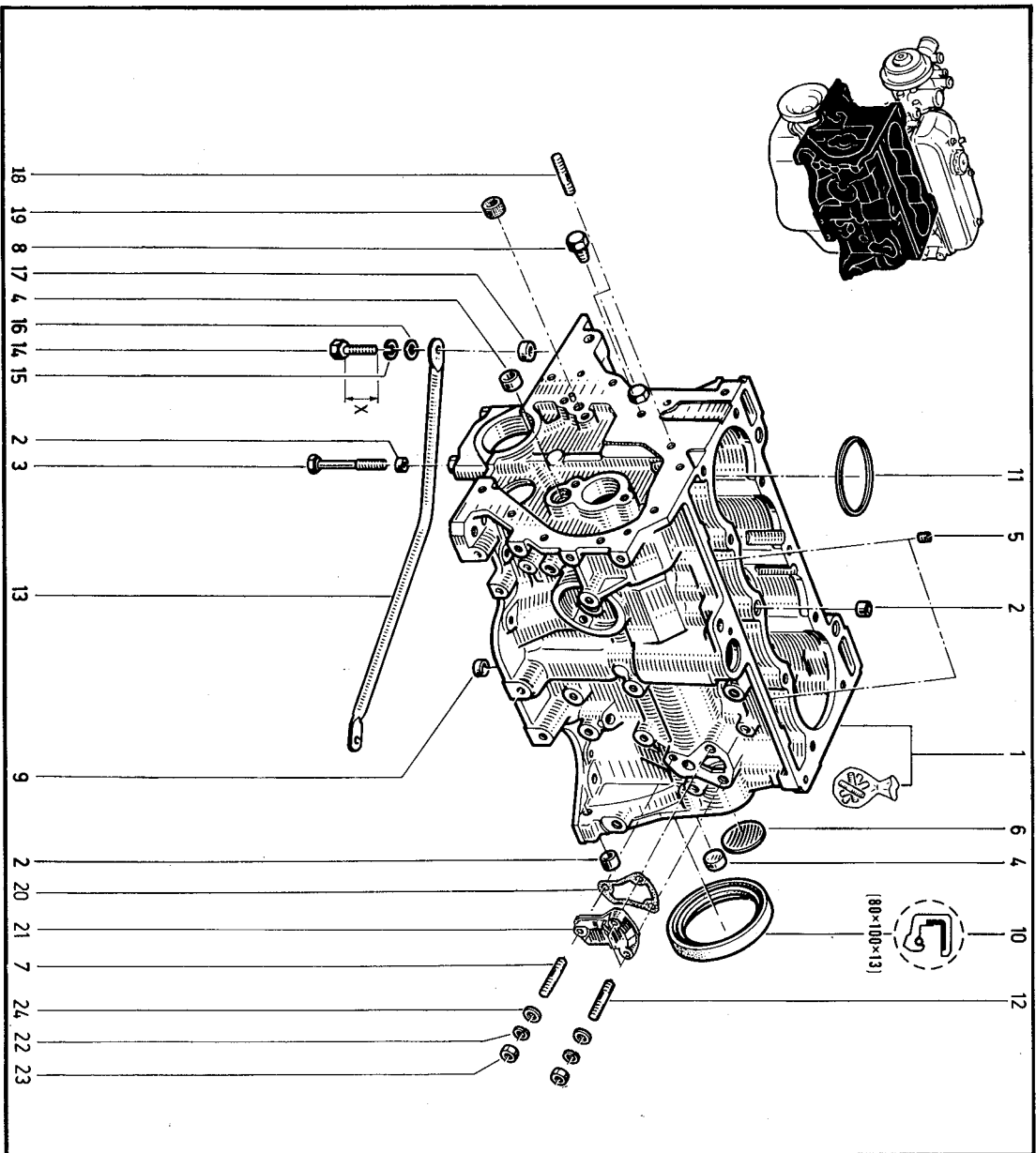

10.40

C.R.1037

(85) 77 00 727 684 - 1

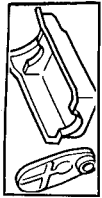

10.50
C.R.1037

- 1 - 77 02 080 649
- 77 02 080 710 (B-375)
- 2 - 79 03 075 033
- 3 - 0949484
- 4 - 77 00 679 691
- 5 - 77 03 053 370
- 6 - 77 03 001 865
- 7 - 77 00 695 581
- 8 - 77 03 001 158
- 9 - 77 03 055 011
- 10 - 77 00 679 693
- 77 02 080 846 (c)
- 11 - 77 01 349 364 (b) +
- 77 01 349 700 (b)
- 12 - 77 04 000 470
- 13 - 77 03 075 135 (a)
- 14 - 77 03 062 011 (a) +
- 06 06 715 000 (a)
- 15 - 77 02 057 212
- 77 02 080 803 (c)
- 16 - 77 02 057 211
- 77 02 080 804 (c)
- 17 - 06 07 190 700 +
- 77 04 000 471
- 18 - 77 02 080 796 (c)

(a) / B372
(b) / B373
(c) / B37T



10.50
C.R.1037

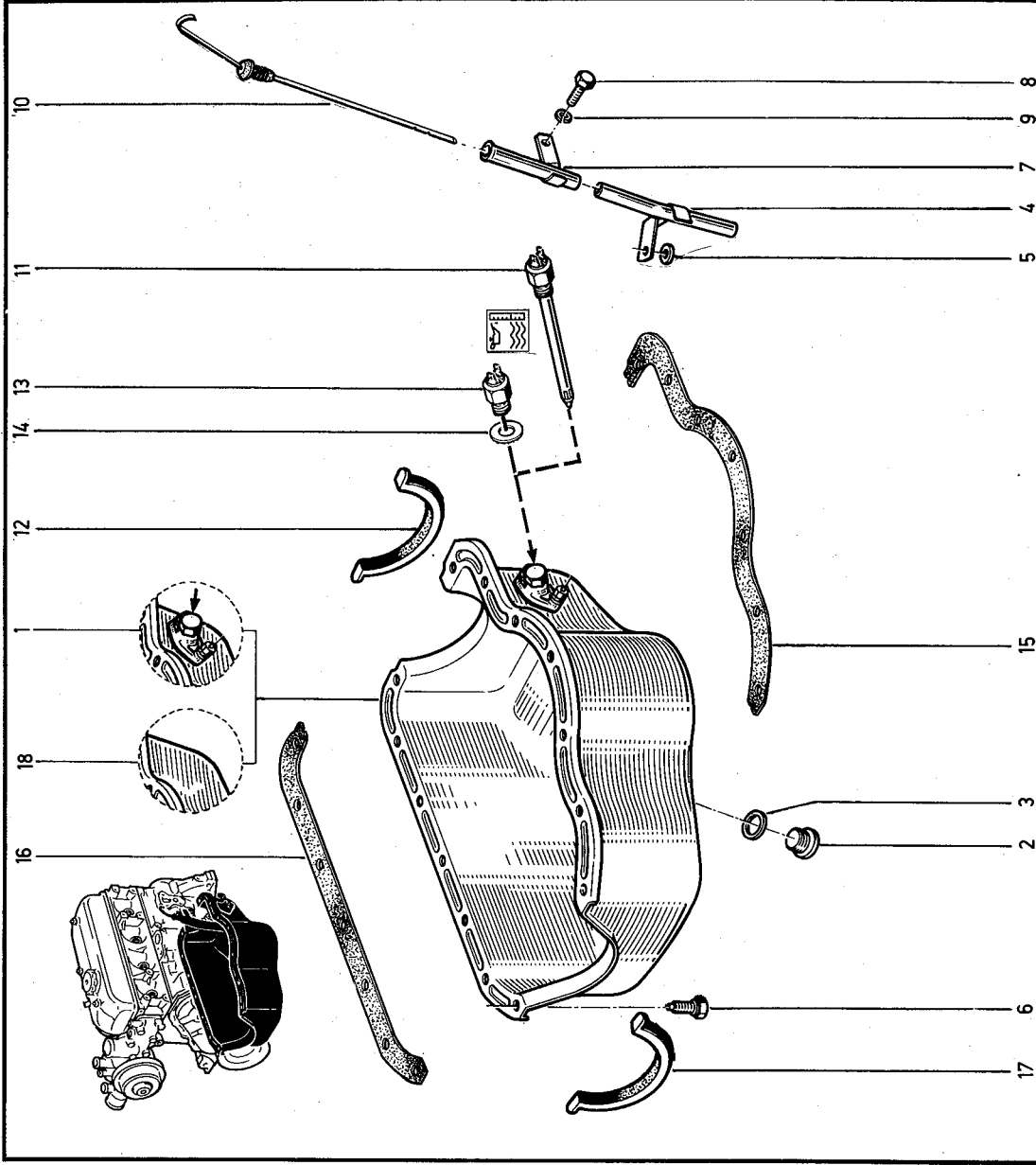

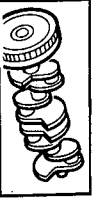

10.60
C.R.1037

- 1 - 77 02 057 095
- 77 02 080 798 (a)
- 2 - 77 00 723 002 +
- 60 01 003 027 (B-375)
- 77 02 080 691
- 77 02 080 789 (a)
- 3 - 77 00 684 504
- 4 - 77 02 056 384
- 5 - 07 06 307 900
- 6 - 77 03 070 009
- 7 - 77 02 023 904
- 8 - 77 00 717 441 +
- 77 02 080 877
- 77 02 080 682 +
- 77 02 080 879
- 9 - 77 00 717 439 **5**
- 77 02 080 681 **5**
- 77 02 057 955
- 10 - 77 03 101 147 +
- 50 03 001 181
- 11 - 77 03 053 541 +
- 77 03 053 348
- 12 - 77 02 057 727
- 13 - 77 00 581 372
- 14 - 77 00 647 657
- 15 - 77 02 023 315
- 77 02 023 933
- 77 02 080 850
- 16 - 77 02 023 316
- 77 02 023 930
- 77 02 080 849
- 17 - 77 02 023 317
- 77 02 023 929
- 77 02 080 848
- 18 - 77 00 709 251 + **3**
- 60 01 006 445 (B-375)
- 77 02 080 679 **3**
- 19 - 77 02 052 342
- 20 - 77 02 074 034

(a) / B37I

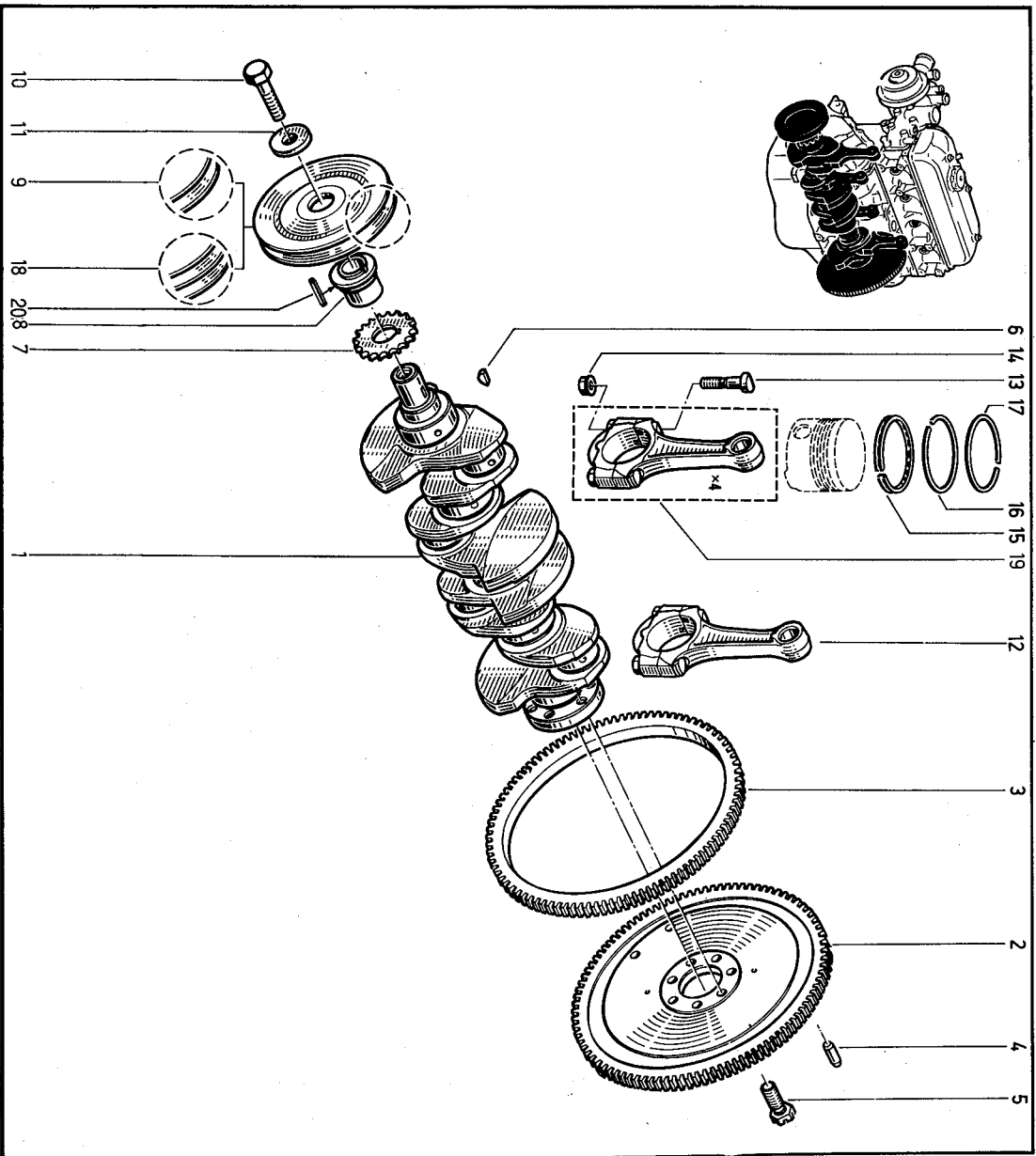

10.60
C.R.1037

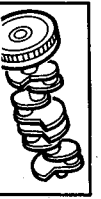

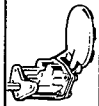

10.70
C.R.1037

- 1 - 77 01 588 187
- 77 02 080 844 (b)
- 77 01 623 894 (a)†
- 77 01 635 029 (a)
- 2 - 77 05 035 079
- 77 02 080 845 (b)
- 3 - 05 55 485 800
- 77 02 080 880 (b)
- 4 - 08 23 897 700
- 77 02 080 838 (b)
- 5 - 06 08 407 000
- 6 - 77 05 015 146
- 7 - 77 03 090 297
- 8 - 06 07 155 000
- 9 - 77 00 672 198
- 10 - 77 03 001 122
- 11 - 79 03 056 008
- 12 - 77 00 556 153 (X - 19)
- 77 02 080 729 (a)
- 77 00 727 684 (b) (X - 20)
- 13 - 77 02 070 200 (X - 19)
- 77 02 088 888 (a)
- 77 00 727 482 (a)
- 77 02 089 522 (b) (X - 20)
- 14 - 77 00 655 787
- 77 02 072 365
- 15 - 06 06 715 000
- 16 - 77 03 001 122
- 17 - 77 00 755 752 (a)
- 18 - 08 55 662 400 (a)
- 19 - 60 01 000 128 (a)
- 20 - 60 01 006 879 (a)

(a) / B375
(b) / B37T

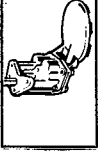

10.70
C.R.1037

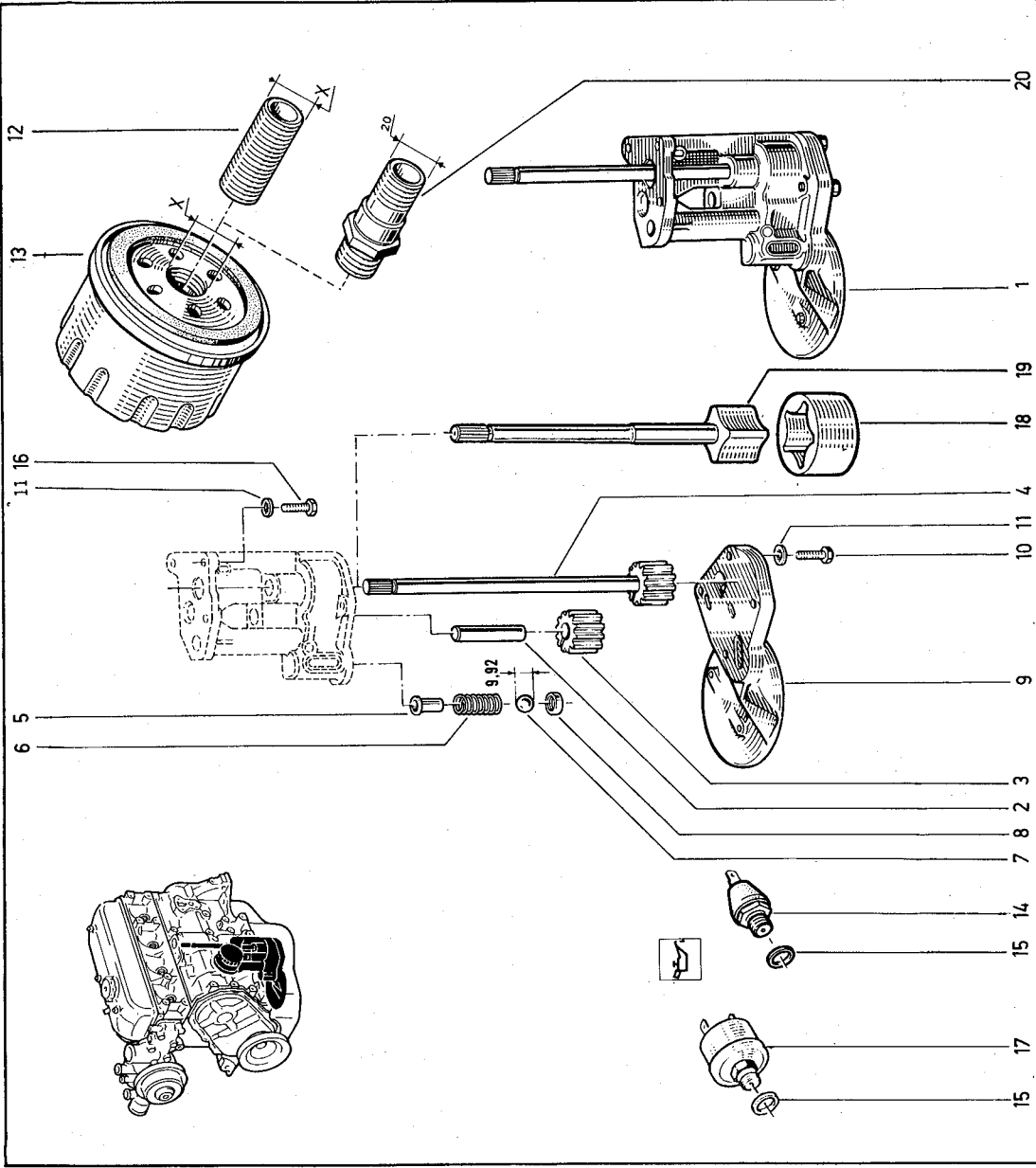

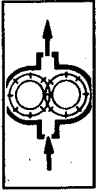

10.80
C.R.1037

- 1 - 60 01 008 132
- 2 - 60 01 006 825
- 3 - 60 01 005 995
- 4 - 60 01 007 136
- 5 - 06 06 715 000
- 6 - 60 01 008 137
- 7 - 77 03 061 090
- 8 - 77 02 093 514
- 9 - 77 02 093 514
- 10 - 77 00 755 752
- 11 - 77 00 667 527
- 12 - 77 00 667 526

B375

10.80
C.R.1037

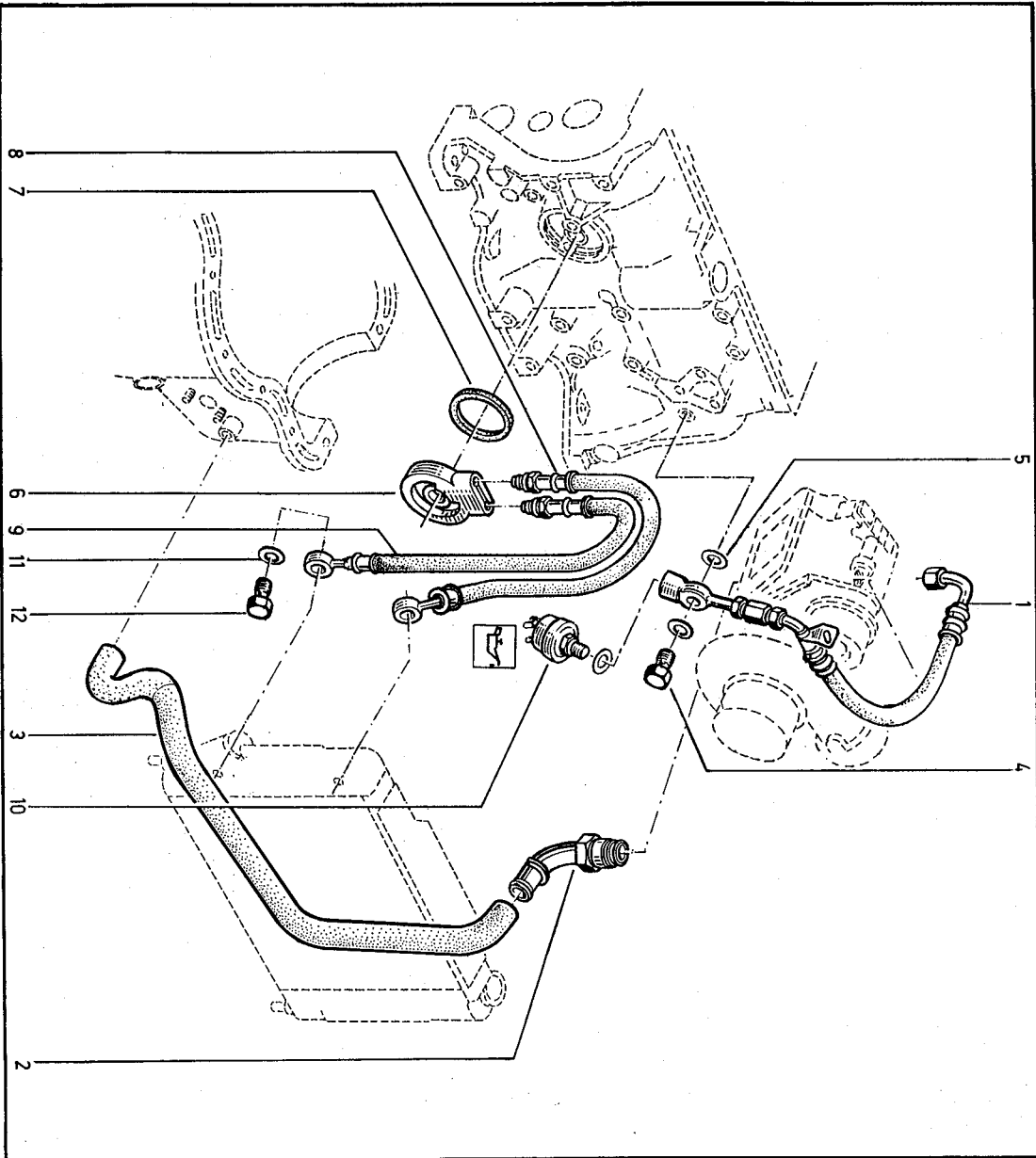
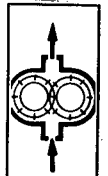



11.01
C.R.1037

- 1 - 77 01 462 145 †
- 77 01 463 377 †
- 77 01 611 384
- 2 - 77 01 349 269 †
- 77 02 080 654
- 77 00 681 418
- 3 - 77 02 080 617
- 4 - 77 03 001 125
- 5 - 79 03 056 008
- 6 - 77 03 001 129
- 7 - 77 03 001 132
- 8 - 77 01 349 314 †
- 77 00 722 762
- 9 - 77 00 655 556
- 10 - 60 01 008 185 (B-375)



11.01
C.R.1037

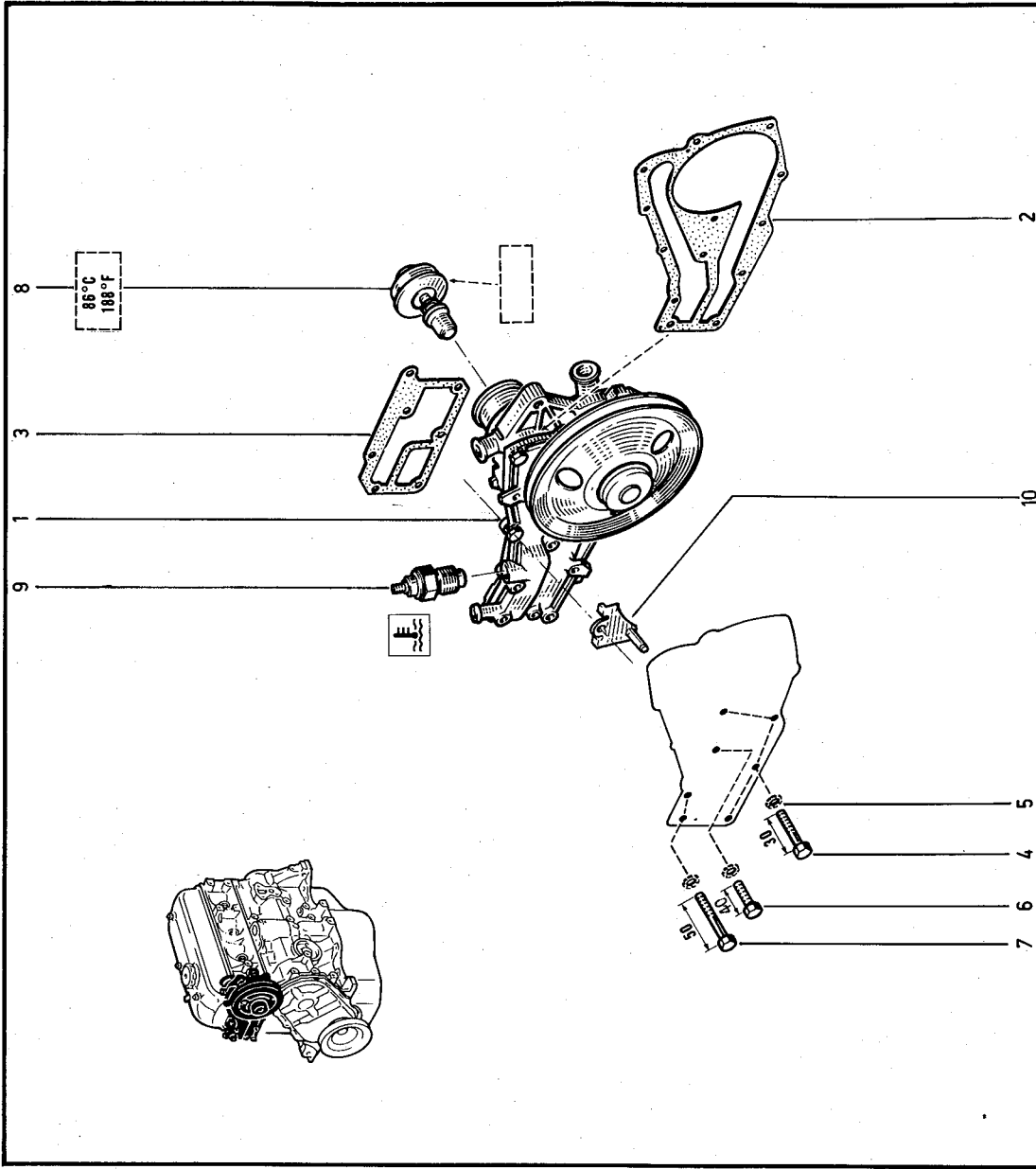

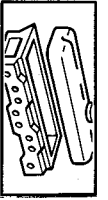

11.20
C.R.1037

- 1 - 77 02 073 363 (a)† (95)
77 02 073 864 (b) (d)
77 02 088 666 (c)
- 2 - 77 02 073 470 (x = 11,10)
77 02 089 203 (x = 11,20)
77 01 460 923 (x = 11,25) (1)
- 3 - 77 02 073 471 (x = 11,25)
77 02 089 205 (x = 11,35)
4 - 07 10 941 000 (x = 11,10)
77 02 089 204 (x = 11,20)
77 02 089 203 (x = 11,20) (c)
- 5 - 07 10 941 100 (x = 11,25)
77 02 089 206 (x = 11,35)
77 02 089 205 (x = 11,35) (c)
- 6 - 77 04 000 287
- 7 - 77 00 566 235
- 8 - 77 03 001 120 (x = 16)
77 03 001 123 (x = 25)
- 9 - 79 03 053 028
- 10 - 07 06 329 400 (x = 15)
77 02 074 035 (x = 32)
- 11 - 77 03 027 114
- 12 - 77 03 027 088
- 13 - 07 06 305 500
- 14 - 07 06 232 400
- 15 - 77 02 080 611 (E = 1,3)
77 02 088 595 (E = 1,75)
60 01 006 830 (c)
60 01 008 156 (c)
77 00 733 041 (c)†
77 01 465 268 (c)
77 02 080 876 (d)†
- 16 - 77 00 706 754
- 17 - 77 03 075 065
- 18 - 77 00 658 325

- (a) / B372
- (b) / B373
- (c) / B375
- (d) / B37T

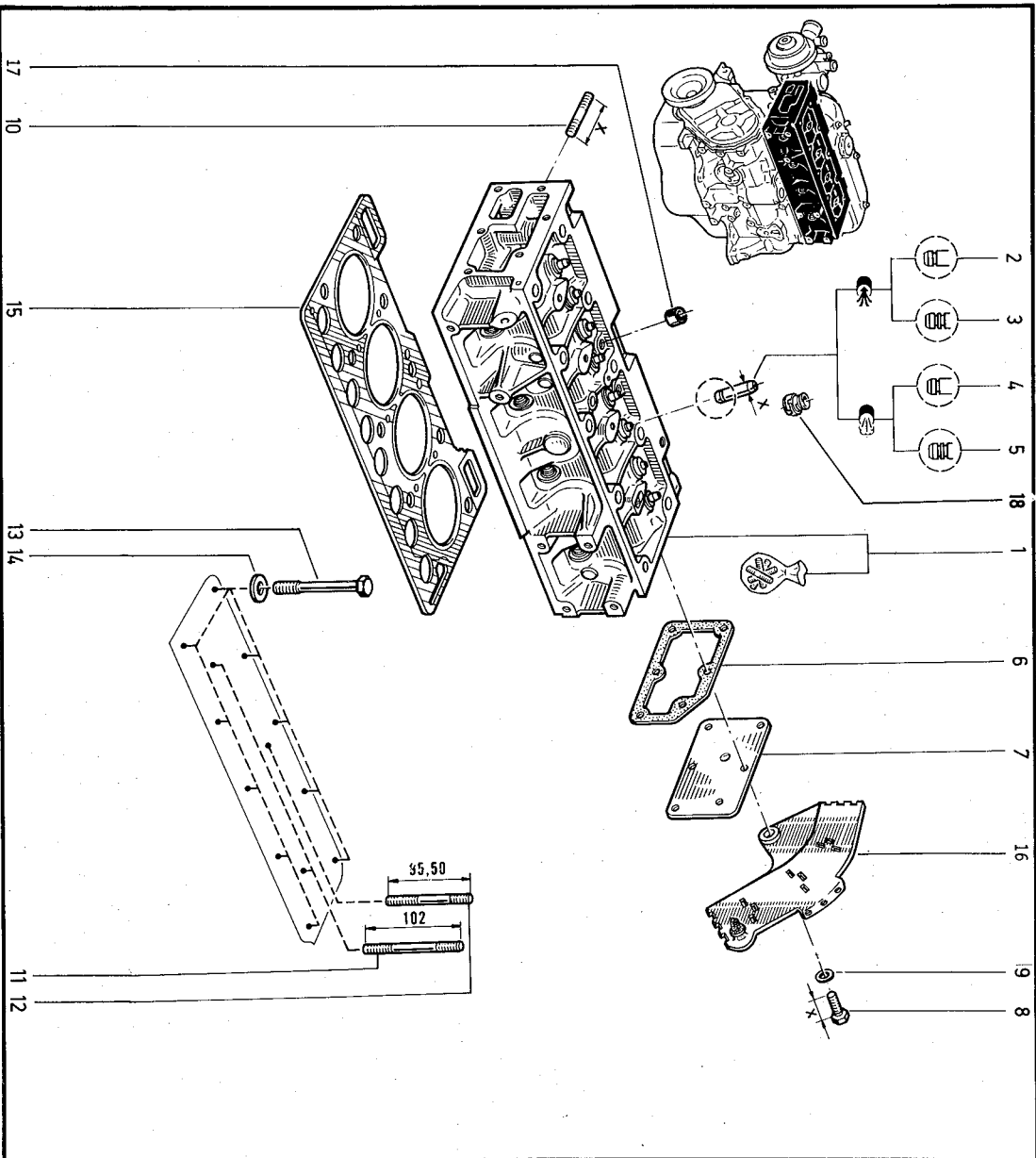

11.20
C.R.1037

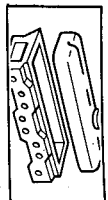

(95) \square 77 02 073 864-1
77 02 021 099-8

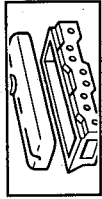

11.30
C.R.1037

- 1 - 77 02 057 273 +
- 77 02 086 385
- 2 - 77 05 035 037
- 3 - 77 03 087 097
- 77 02 086 463
- 4 - 77 03 001 865
- 5 - 77 00 677 715
- 6 - 77 00 723 967
- 7 - 0120392
- 8 - 77 03 033 002 +
- 77 03 033 027
- 9 - 77 00 675 931
- 77 00 721 928
- 10 - 77 00 718 985 +
- 11 - 77 03 015 094
- 12 - 77 03 078 113
- 13 - 77 03 058 002
- 14 - 79 03 032 009
- 15 - 77 02 057 213
- 16 - 77 02 057 732 *

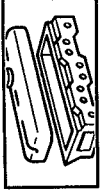

11.30
C.R.1037

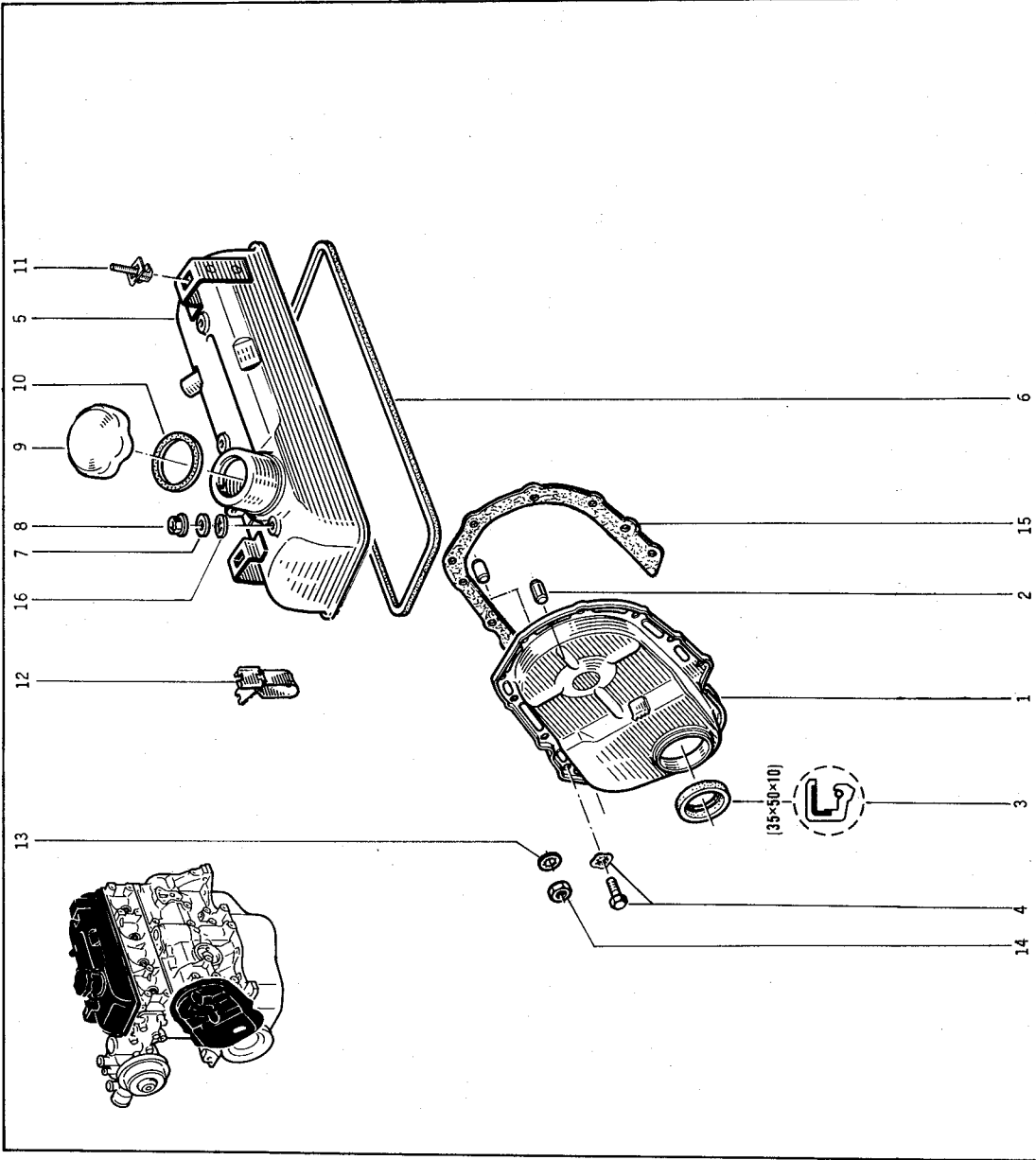

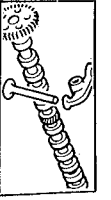

11.40

C.R.1037

- 1 - 77 00 694 279 (a) (c)
- 2 - 77 00 686 473 (b)
- 3 - 77 03 001 118
- 4 - 79 03 056 037
- 5 - 77 03 082 013
- 6 - 77 04 001 718
- 7 - 77 00 655 335
- 8 - 77 03 001 243
- 9 - 77 00 655 331
- 10 - 77 01 349 098
- 11 - 77 00 578 993 +
- 12 - 77 03 001 125
- 13 - 79 03 056 037
- 14 - 05 55 485 700 +
- 15 - 77 00 690 122 (x = 19)
- 16 - 77 00 682 064
- 17 - 77 00 509 768
- 18 - 77 00 655 195
- 19 - 77 00 512 368
- 20 - 08 54 895 300
- 21 - 77 00 666 112 +
- 22 - 08 54 895 300
- 23 - 77 00 579 928 (x = 173) (a)
- 24 - 77 00 651 640
- 25 - 08 54 592 002
- 26 - 79 03 032 012
- 27 - 77 03 001 667
- 28 - 77 00 618 184
- 29 - 77 03 066 313
- 30 - 77 00 521 453
- 31 - 77 02 023 592 (c)
- 32 - 77 00 710 231
- 33 - 06 07 281 700
- 34 - 06 07 153 700
- 35 - 77 00 651 641 +
- 36 - 08 55 174 000
- 37 - 08 55 173 900
- 38 - 77 02 023 587 (c)
- 39 - 77 02 023 586 (c)
- 40 - 77 01 463 181 (c)

- 77 02 080 889 (c) +
- 60 01 008 124 (c) +
- 77 02 080 856 (d)
- 77 02 080 856 (d)
- 07 10 937 700 (x = 19,20) +
- 77 01 462 573 (x = 19,20)
- 77 02 080 882 064
- 77 00 655 195
- 77 00 512 368
- 77 00 666 112 +
- 60 01 004 967 (c) + (85).
- 77 02 021 099 (x = 170) (b) (c)

(a) / B372
 (b) / B373
 (c) / B375

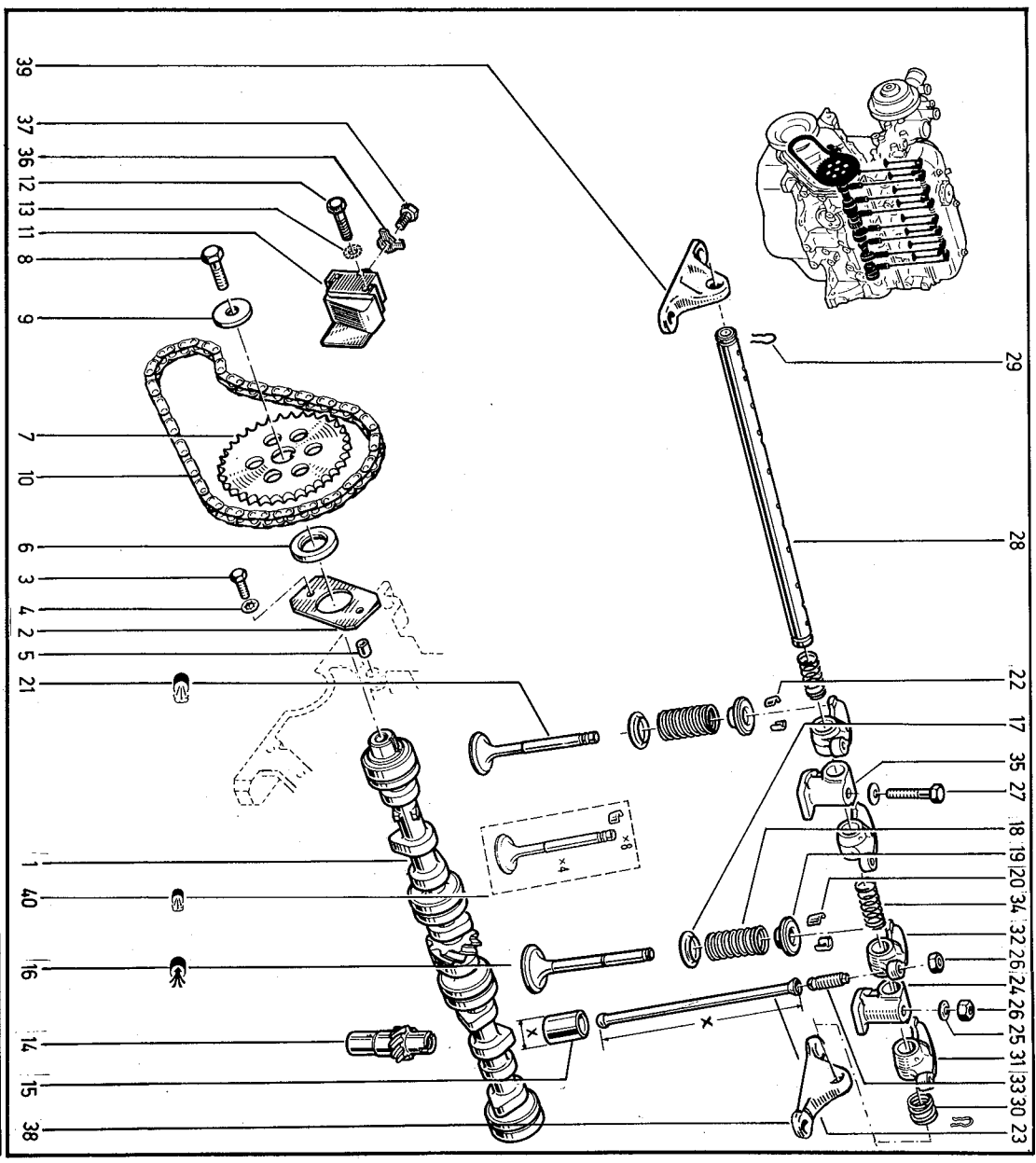

11.40

C.R.1037



(85) F 77 01 463 181 -1

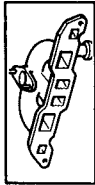

12.01
C.R.1037

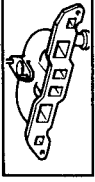

12.01
C.R.1037

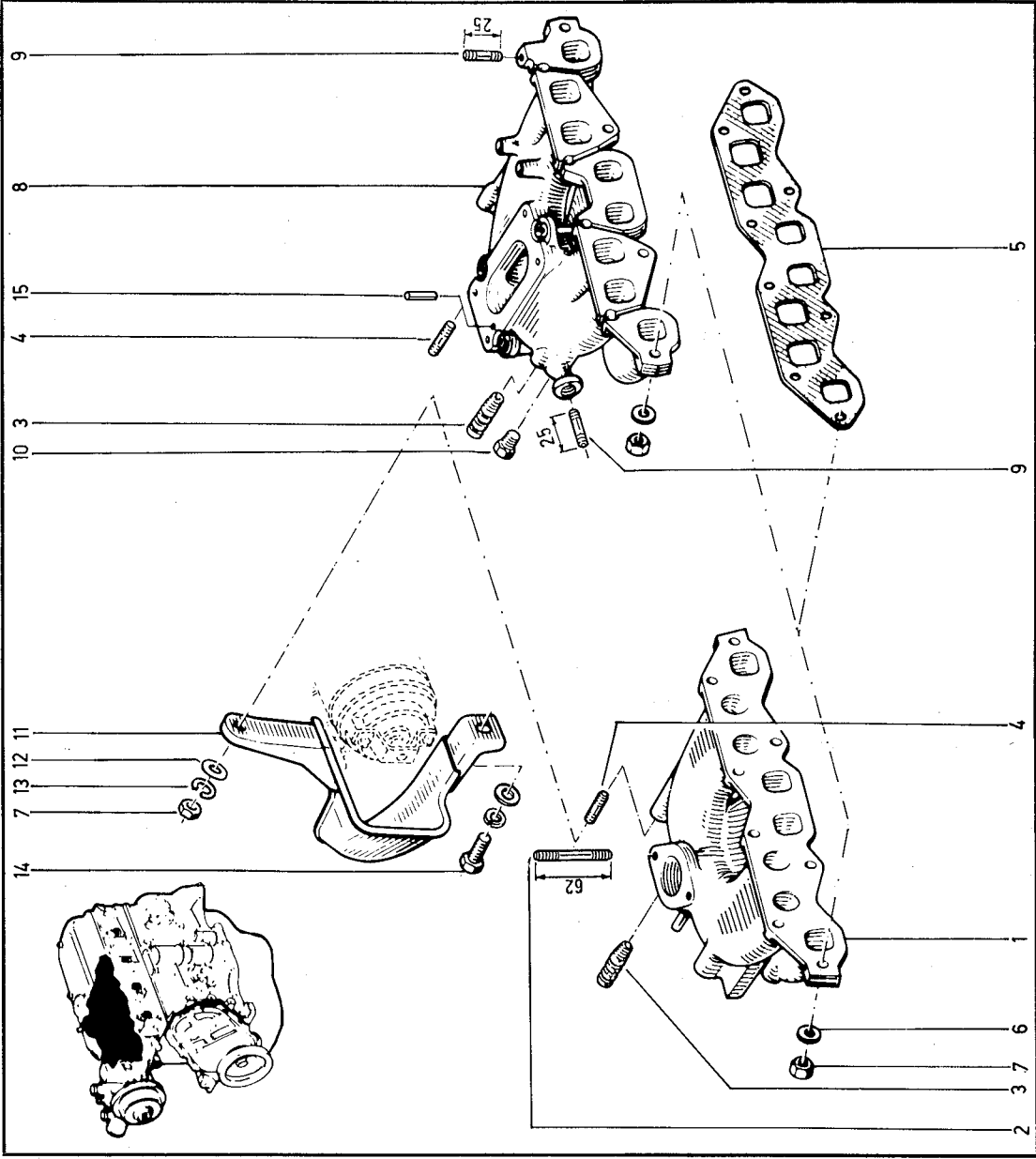

- 1 - 77 00 675 366
- 2 - 77 02 056 084
- 3 - 77 00 669 692
- 4 - 77 05 030 090
- 4 - 77 03 027 048
- 5 - 77 02 080 612
- 5 - 77 00 697 874
- 6 - 77 03 053 037
- 7 - 77 03 032 047
- 8 - 77 00 716 188
- 9 - 77 03 027 092
- 10 - 77 03 075 009
- 11 - 77 00 708 197 (a)
- 77 02 086 407 (b)
- 77 00 708 201 (b) †
- 12 - 77 03 053 037
- 13 - 77 03 055 011
- 14 - 77 03 001 158
- 15 - 77 03 067 079

(a) / B373

(b) / B372

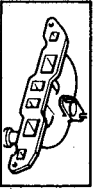

12.02
C.R.1037

- 1 - 60 01 005 985
- 2 - 60 01 008 146
- 60 01 009 269
- 3 - 77 00 716 580
- 4 - 77 00 542 495
- 5 - 77 03 062 007
- 6 - 77 02 080 762
- 7 - 77 03 027 167
- 8 - 77 03 053 037
- 9 - 77 03 032 047
- 10 - 77 03 034 120
- 11 - 77 02 056 084
- 12 - 60 01 008 123
- 13 - 77 03 062 001
- 14 - 60 01 008 199
- 15 - 77 02 080 763

B375

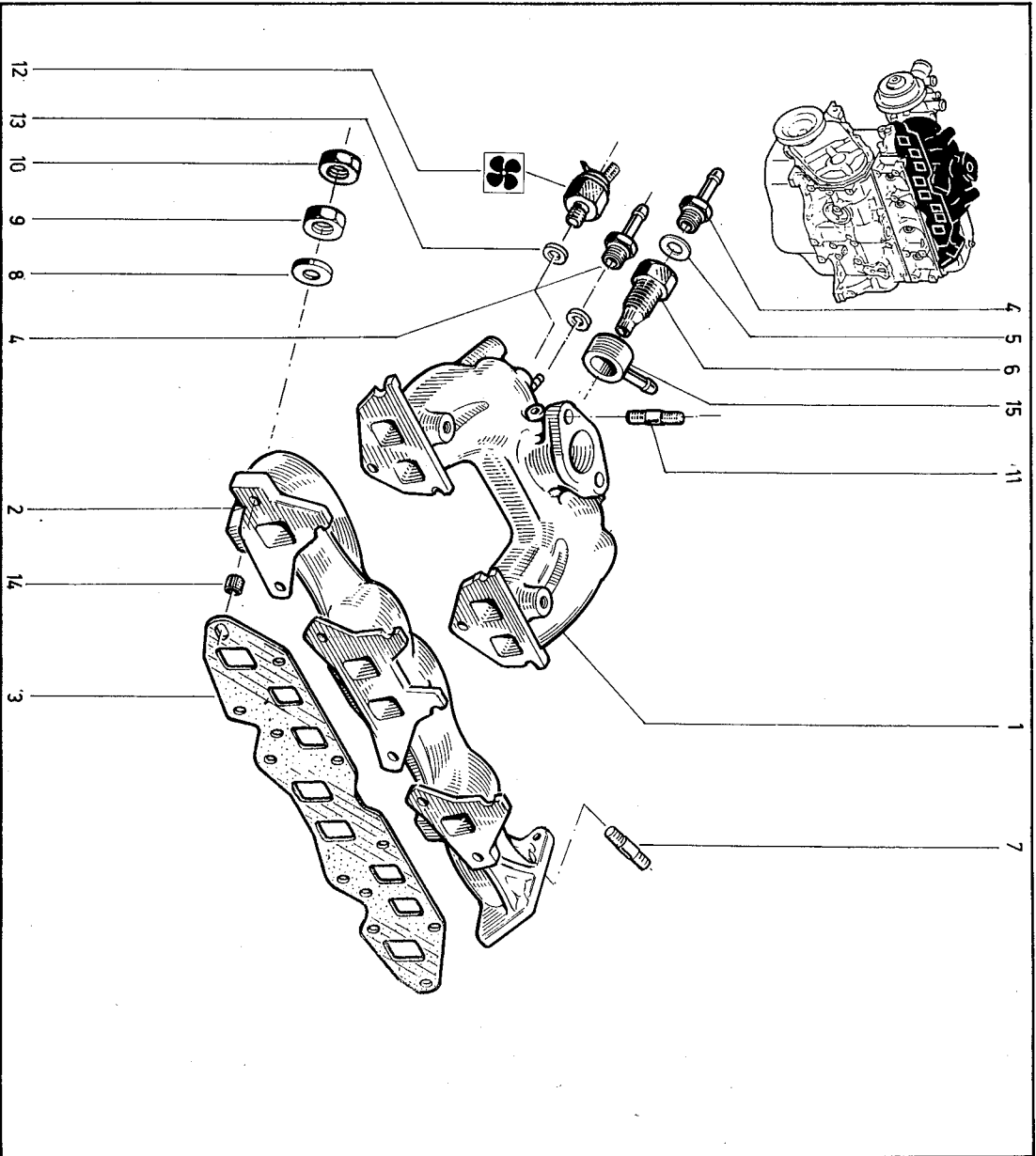

12.02
C.R.1037

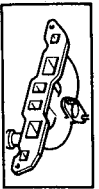



12.05
C.R.1037

- 1 - 77 00 536 796
- 2 - 77 00 656 238
- 3 - 77 03 055 011
- 4 - 77 03 032 049
- 5 - 60 01 003 032
- 6 - 60 01 004 025
- 7 - 77 00 692 166
- 8 - 77 03 001 120
- 9 - 77 03 001 118
- 10 - 77 03 055 007
- 11 - 77 00 733 343
- 12 - 60 01 005 964

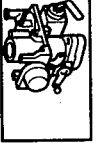

12.05
C.R.1037

B375

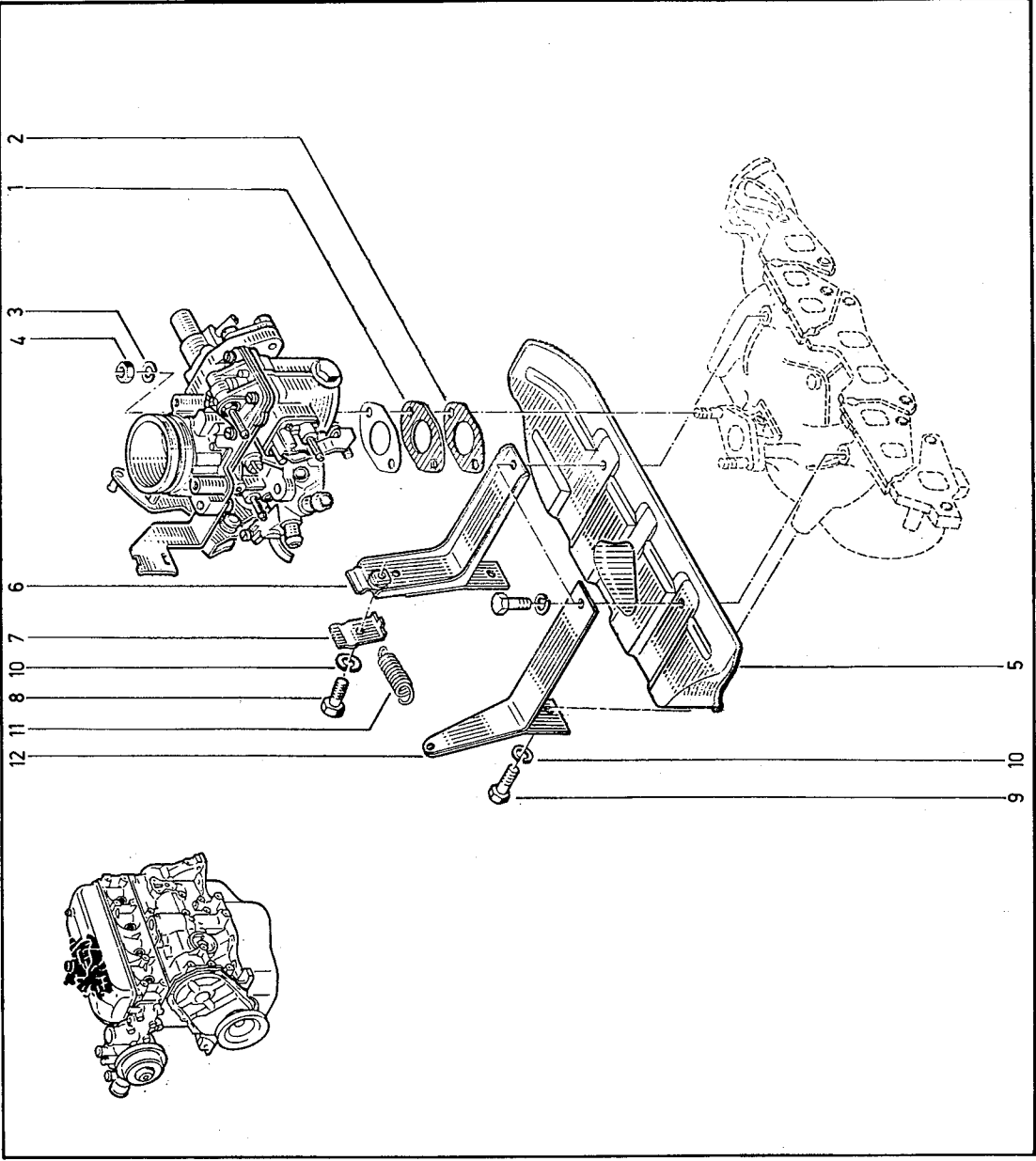



12.10

C.R.1037

- 1 - 77 00 536 796
- 2 - 77 00 656 238
- 3 - 77 00 693 949
- 4 - 06 07 059 200
- 5 - 77 03 032 049
- 6 - 77 00 722 933
- 7 - 77 05 016 004
- 8 - 79 03 056 037
- 9 - 77 03 001 118
- 10 - 77 00 692 166
- 11 - 77 03 001 120
- 12 - 77 03 055 011

B372

12.10

C.R.1037

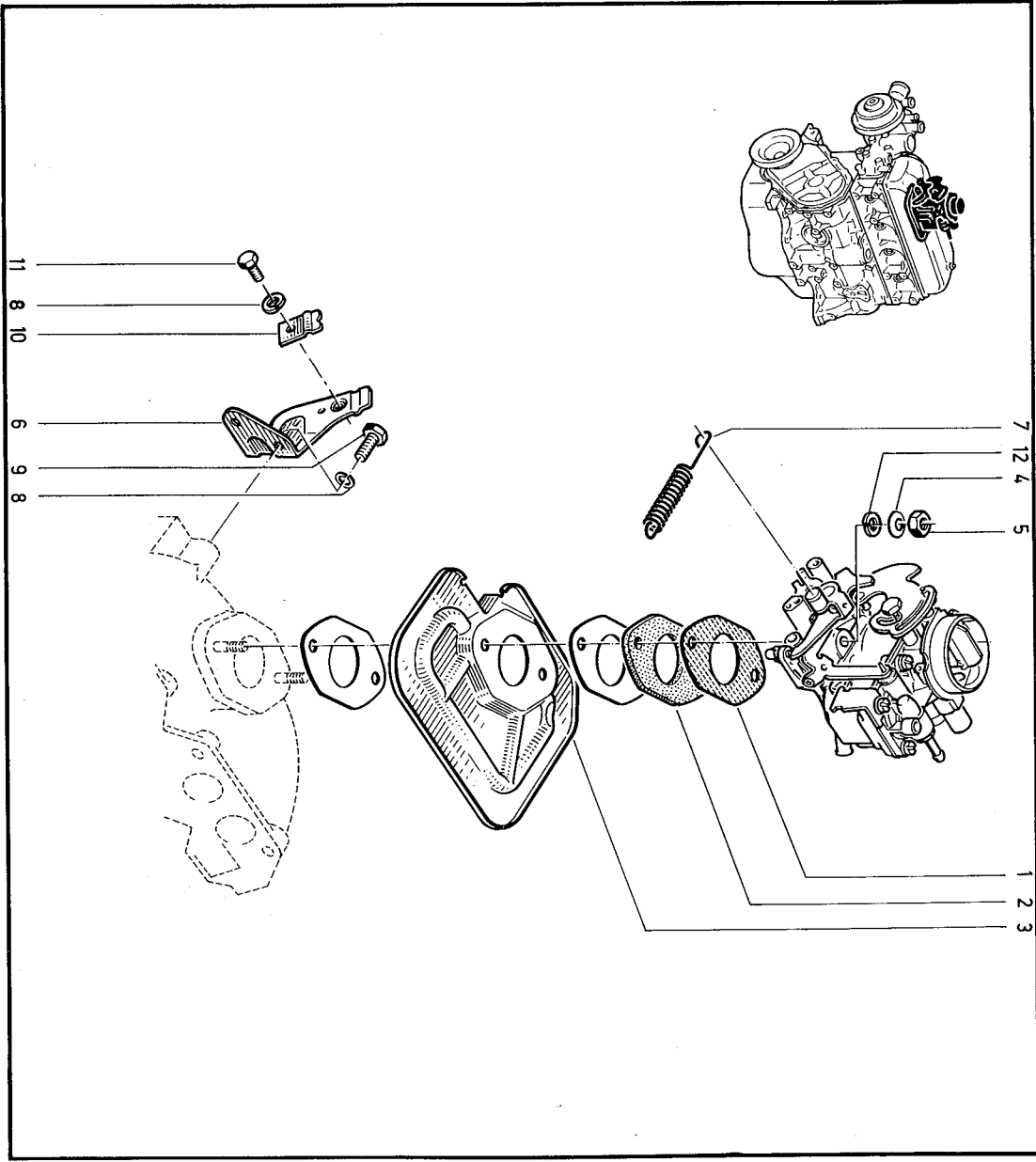

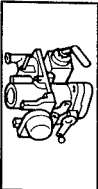

12.11
C.R.1037

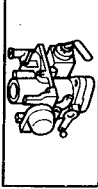

12.11
C.R.1037

SOLEX-BIS 865

- 1 - 77 00 764 215
- 2 - 77 02 073 828
- 3 - 77 01 027 994
- 4 - 77 02 073 831 +
- 5 - 77 01 028 002
- 6 - 77 01 027 993

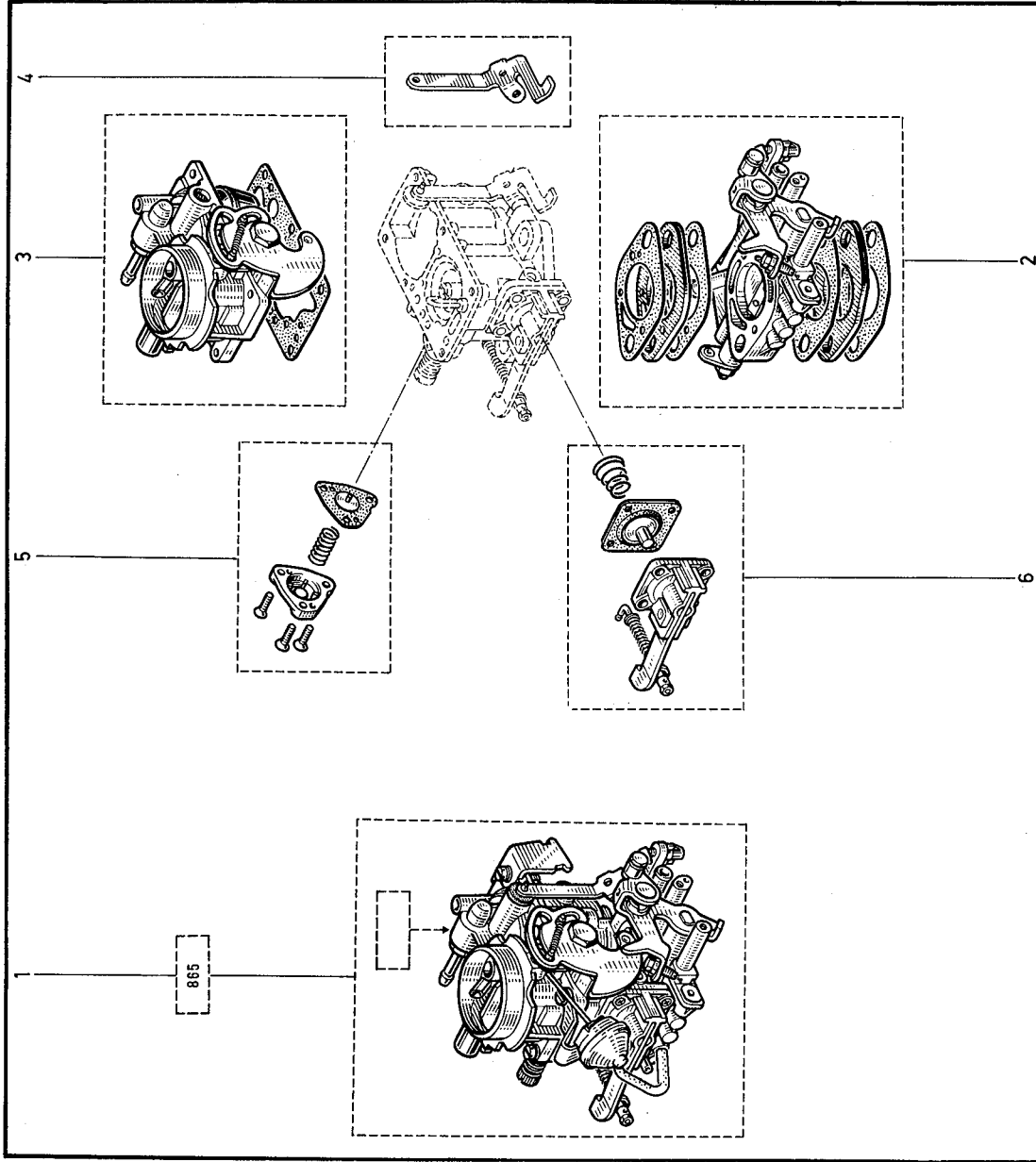



12.11.1
C.R.1037

- 1 - 77 02 080 746
- 2 - 77 02 206 340
- 3 - 77 02 206 341
- 4 - 77 02 073 831

SOLEX 32 BIS

12.11.1
C.R.1037

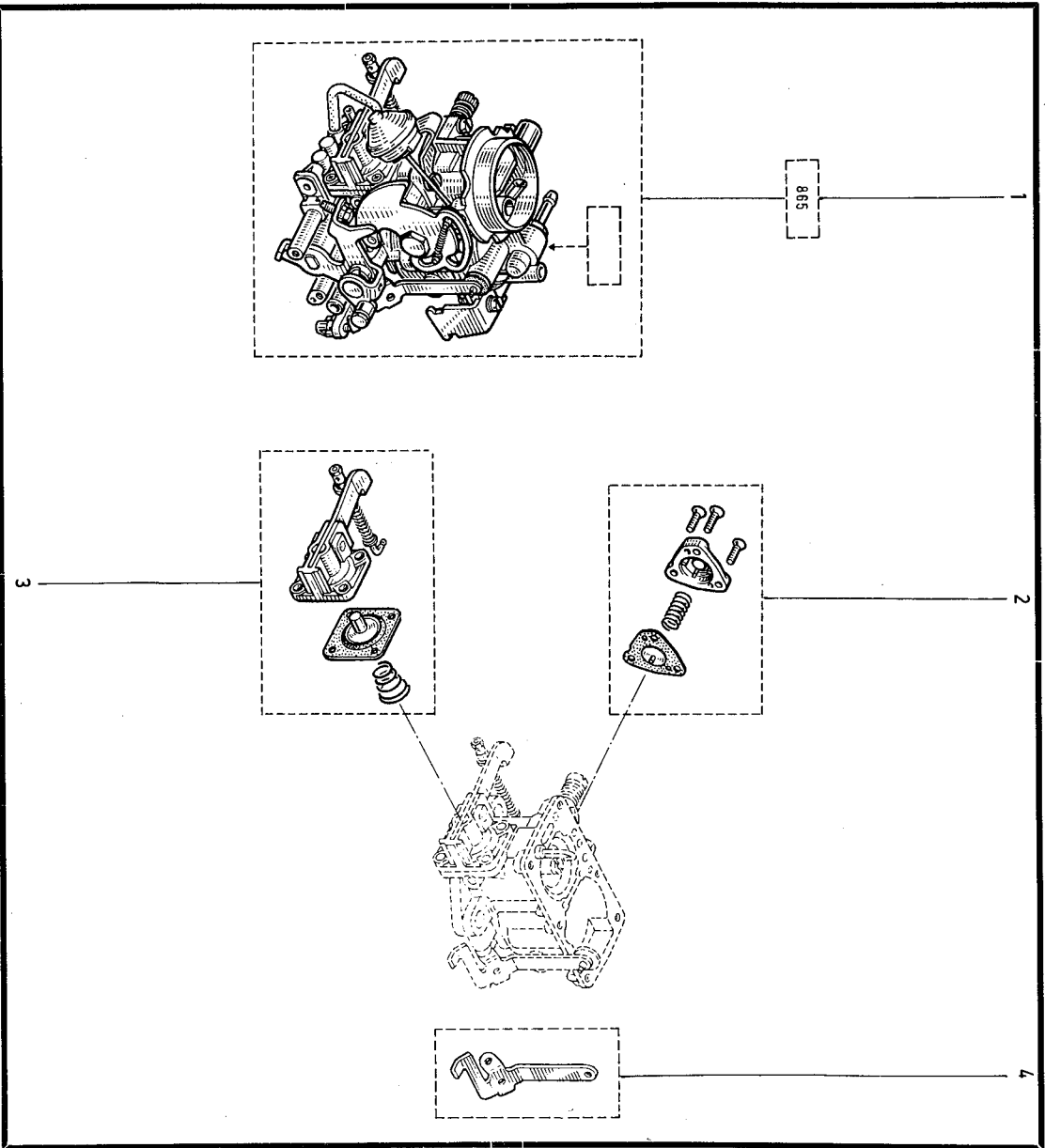



12.12
C.R.1037

- 1 - 77 01 020 611
- 2 - 77 01 016 137
- 3 - 77 01 013 522
- 4 - 77 02 073 829
- 5 - 77 02 073 830 +
- 77 01 030 669
- 6 - 77 01 200 831
- 7 - 77 01 029 574
- 8 - 77 02 073 832
- 9 - 77 01 027 743
- 10 - 77 02 073 833
- 11 - 77 02 073 834 +

SOLEX-BIS



865

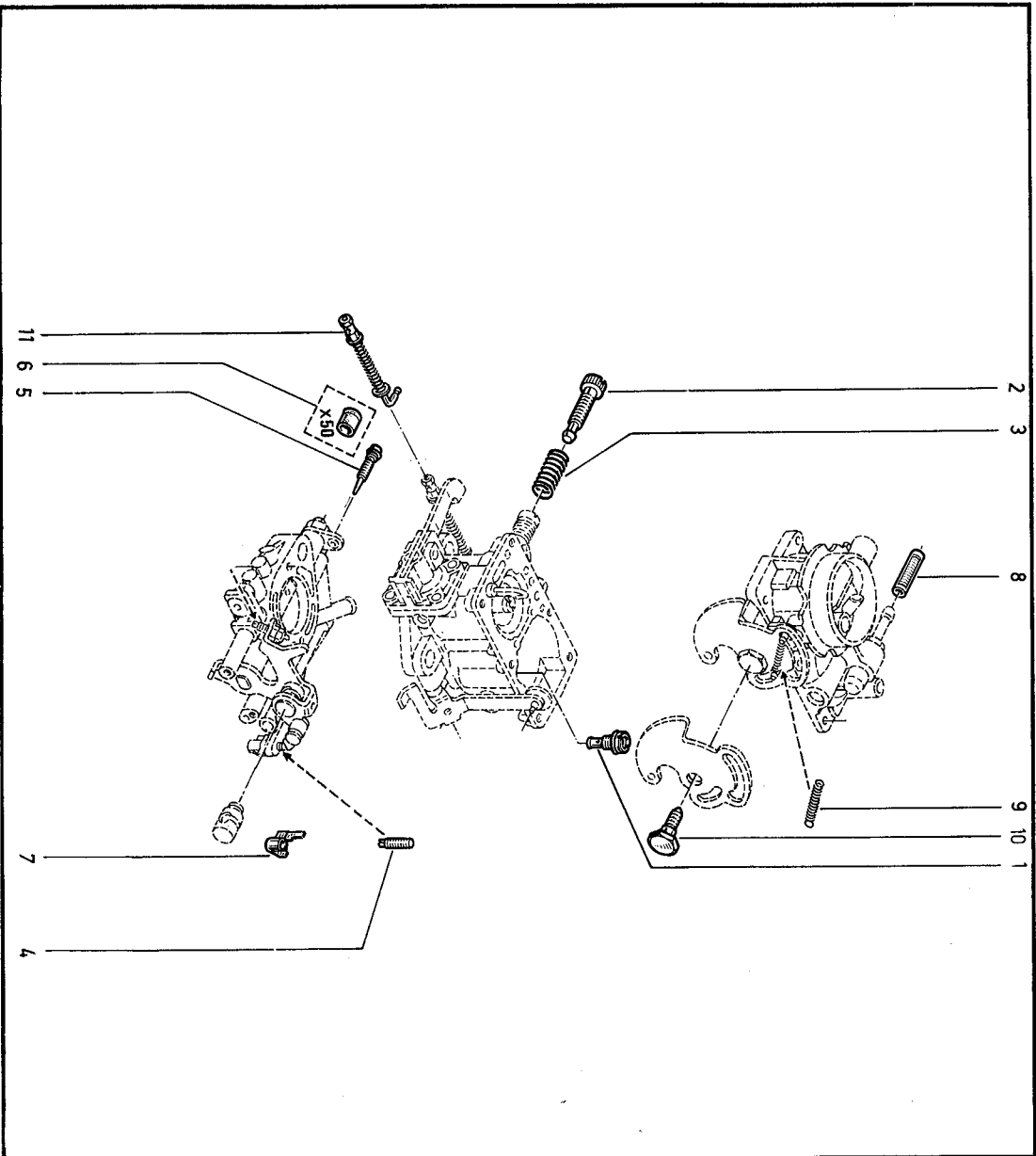

12.12
C.R.1037



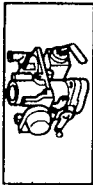

12.12.1
01.80 C.R.1037

- 1 - 77 01 020 611
- 2 - 77 02 073 833
- 3 - 77 02 206 342
- 4 - 77 02 073 832
- 5 - 77 01 030 669
- 6 - 77 02 206 344

SOLE X 32 BIS



12.12.1
C.R.1037

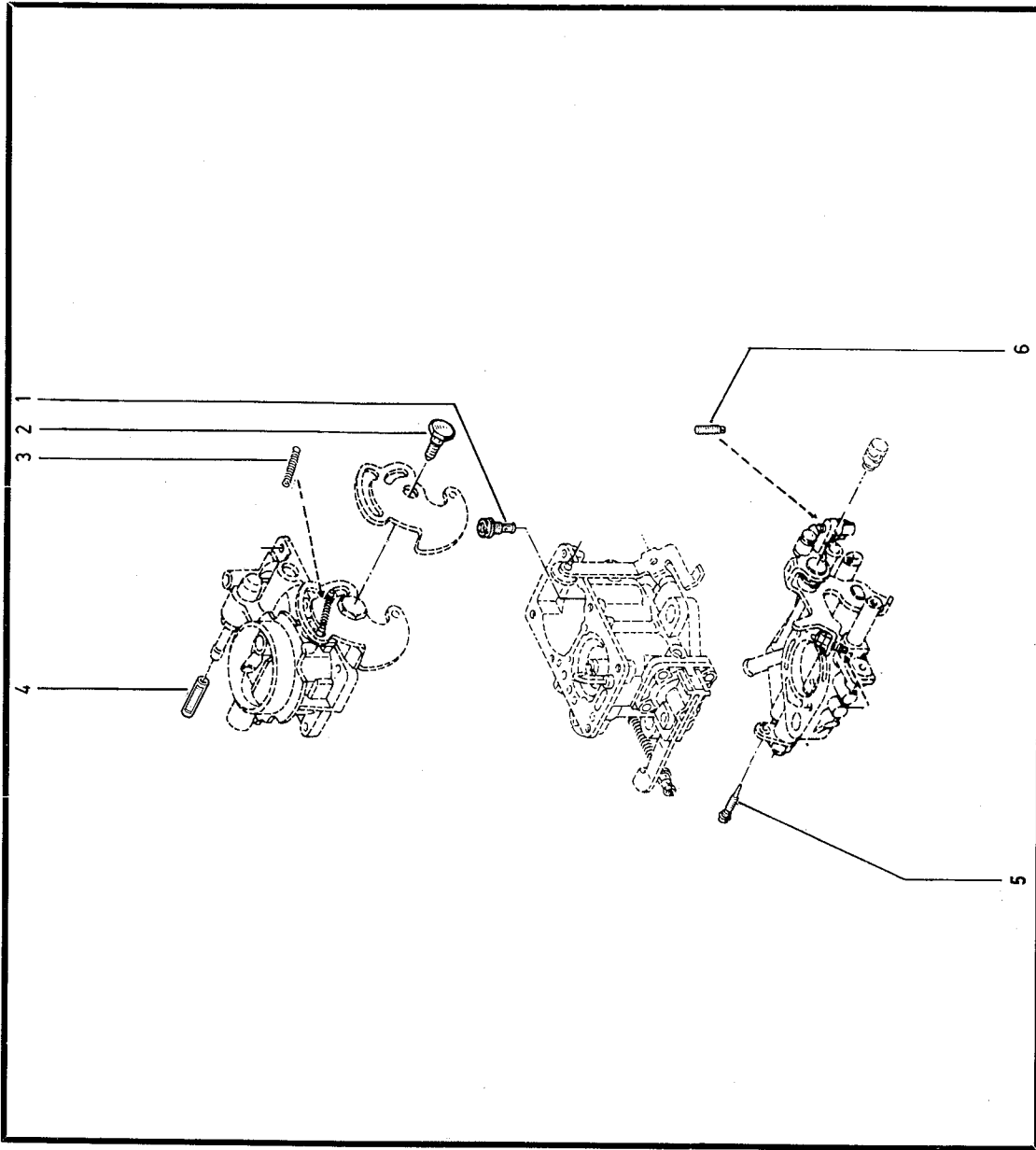

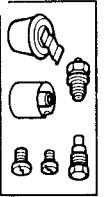

- 1 - 77 01 027 998
- 2 - 08 53 996 431
- 3 - 77 01 018 981
- 4 - 77 01 027 842
- 5 - 77 01 027 999
- 6 - 77 01 028 004
- 7 - 77 01 026 390

12.13
C.R.1037

SOLEX-BIS  866

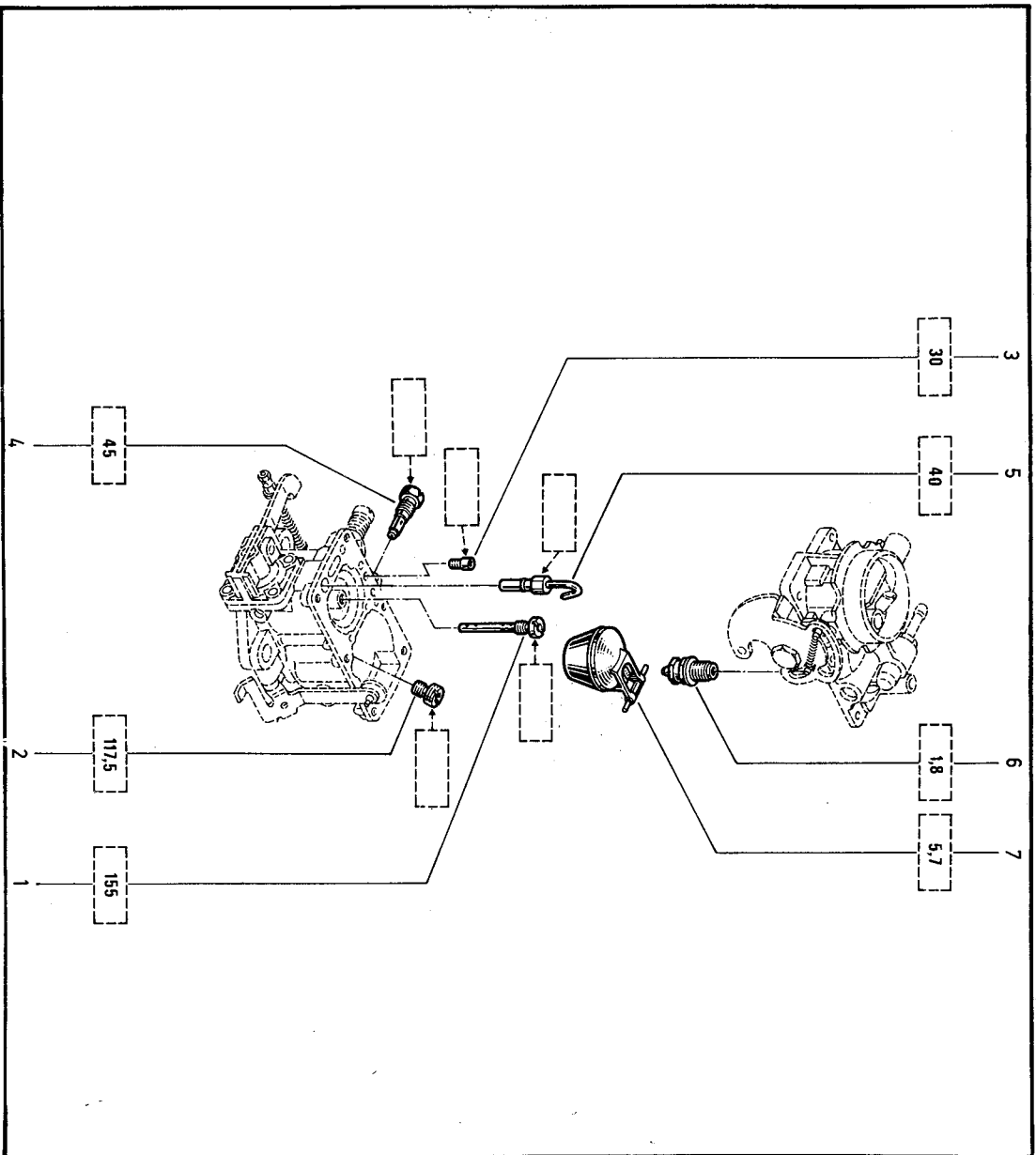

12.13
C.R.1037

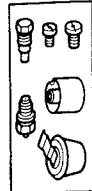

12.13.1
C.R.1037

- 1 - 77 02 206 345
- 2 - 08 53 996 431
- 3 - 77 02 206 346
- 4 - 77 01 027 999
- 5 - 77 02 206 347
- 6 - 77 01 026 390

[S.O.L.E.X.]32 BIS

12.13.1
C.R.1037

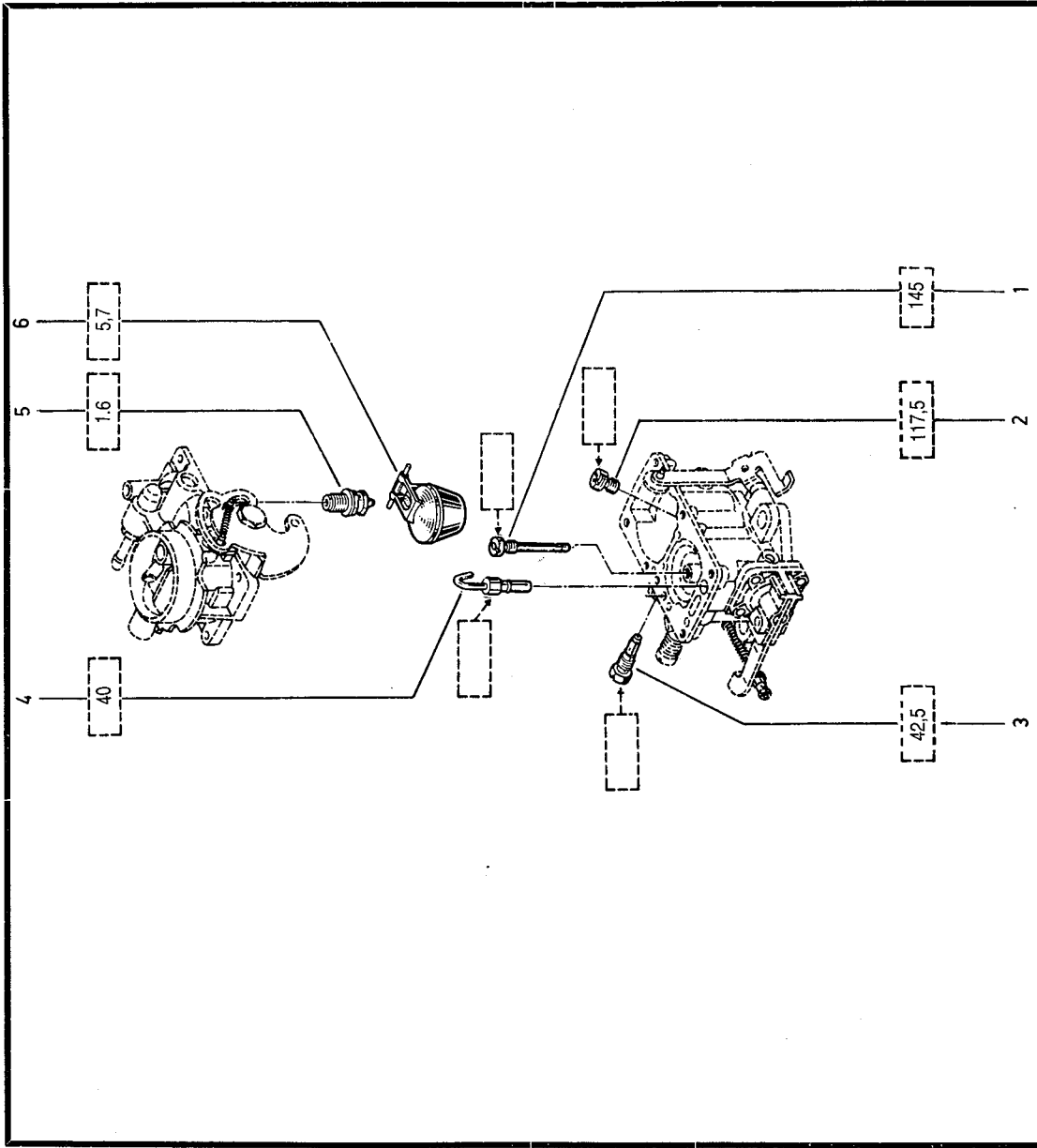
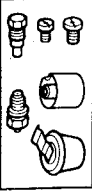

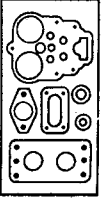

- 1 - 77 01 201 752
- 2 - 77 01 201 753
- 3 - 77 01 201 754

12.14
C.R.1037

SOLEX-BIS



885

12.14
C.R.1037

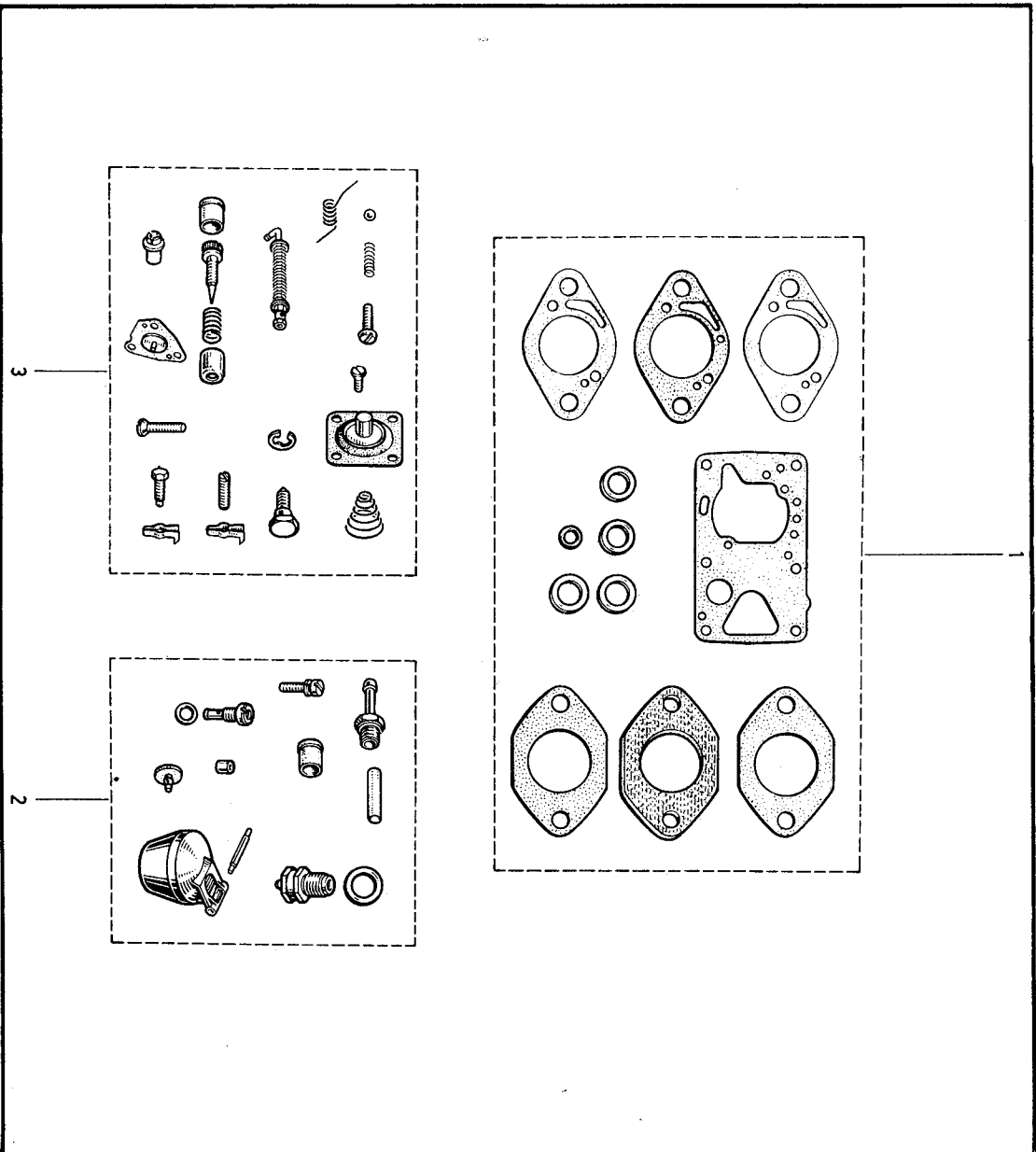
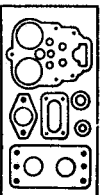

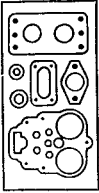

12.14.1
C.R. 1037

- 1 - 77 02 206 348
- 2 - 77 02 206 349
- 3 - 77 02 206 350

[SOLEX]32 BIS

12.14.1
C.R. 1037

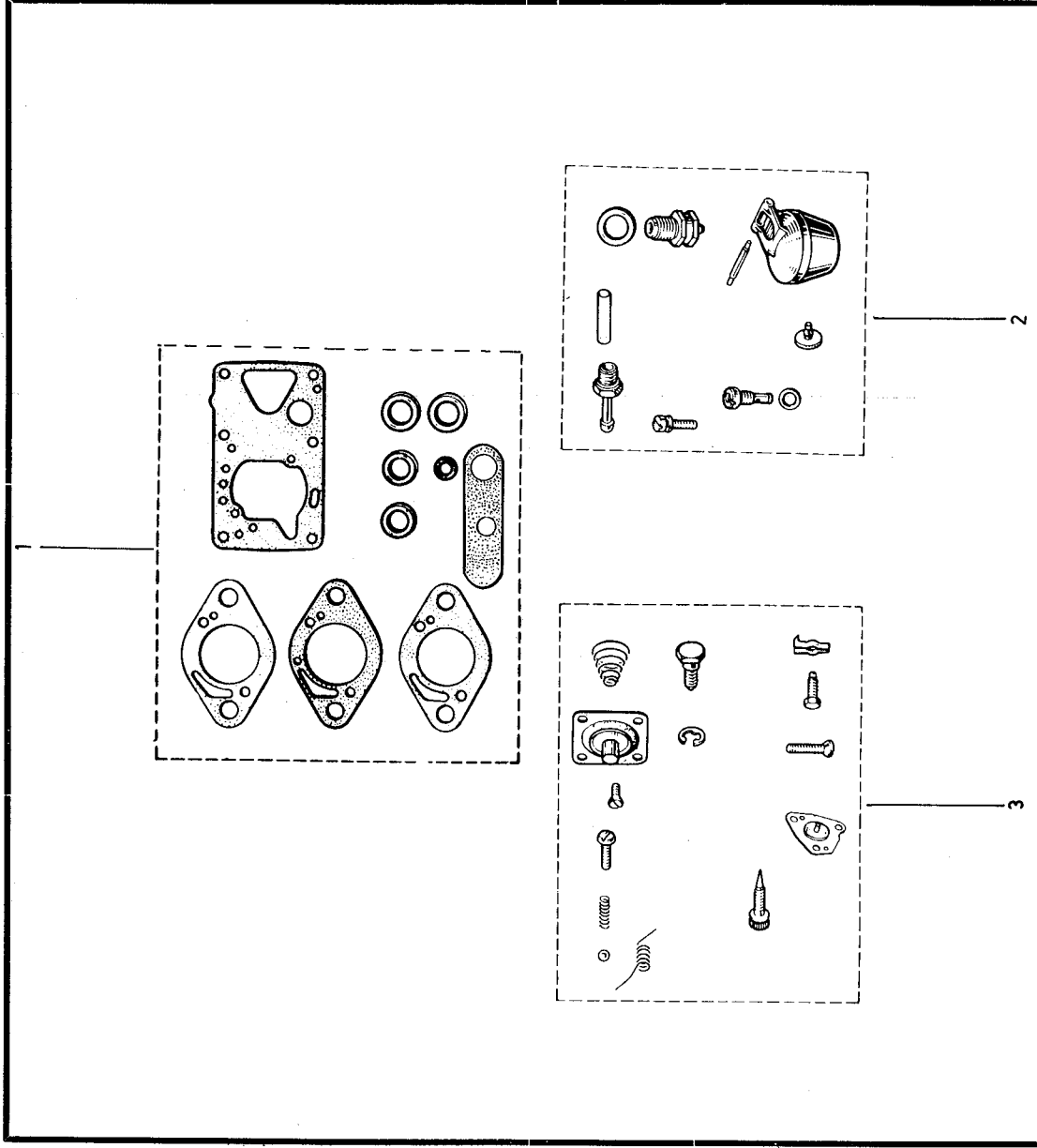
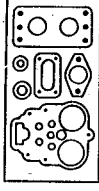



12.15
C.R.1037

- 1 - 77 04 002 238
- 2 - 77 00 714 975
- 3 - 77 04 002 239
- 4 - 77 03 009 117
- 5 - 79 03 053 157
- 6 - 77 00 679 141
- 7 - 79 03 057 013
- 8 - 79 03 032 009
- 9 - 77 00 705 434
- 10 - 79 03 053 043
- 11 - 77 02 020 177
- 12 - 77 02 080 632
- 13 - 77 05 016 005
- 14 - 77 00 723 611
- 15 - 77 00 692 166
- 16 - 77 03 001 120
- 17 - 77 03 055 007
- 18 - 77 03 055 022
- 19 - 77 02 089 829 (a)

B373-B37T

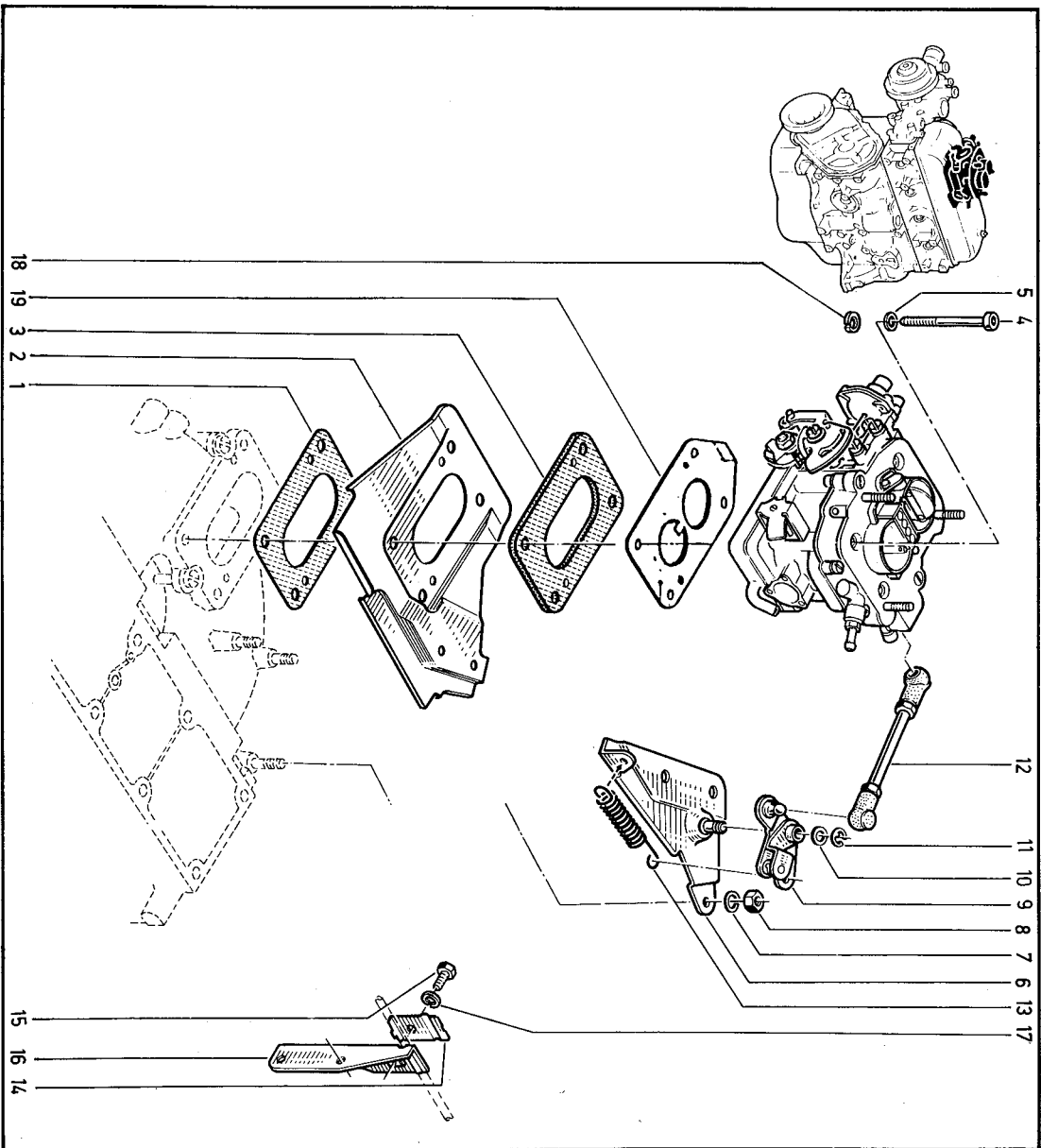

12.15
C.R.1037



(a) / B37T



12.18

C.R.1037

- 1 - 77 00 716 310
- 2 - 77 00 716 309
- 3 - 77 01 030 705
- 4 - 77 01 030 852
- 5 - 77 00 726 566
- 6 - 77 00 726 567
- 7 - 77 02 080 740
- 77 00 732 907
- 8 - 77 02 080 745

- ☒
- ☒
- ☒
- ☒
- ☒
- ☒
- ☒
- ☒
- ☒
- ☒
- ☒
- ☒
- ☒
- +
- ☒ (a)

32 DRT 2 WEBER

12.18

C.R.1037

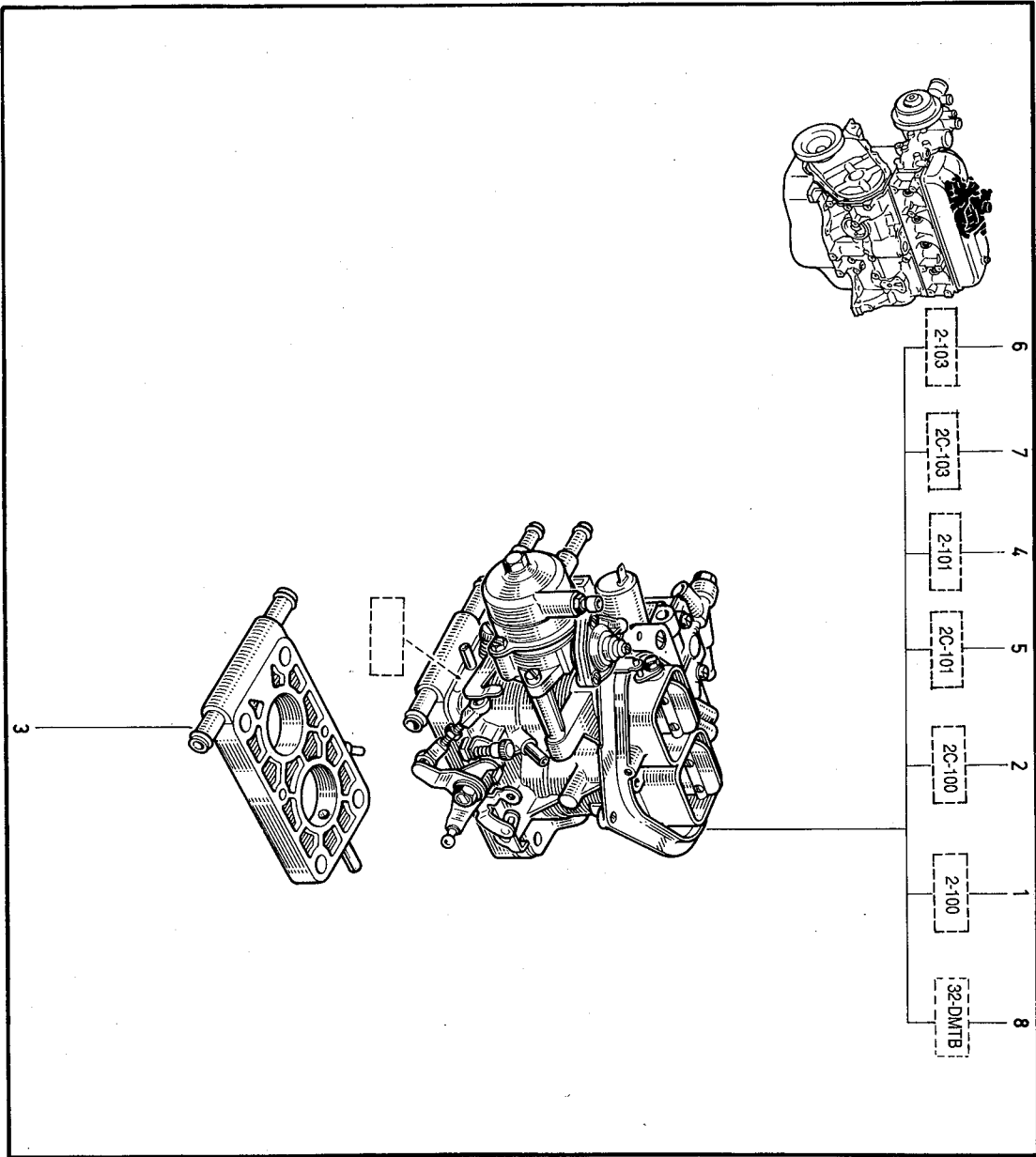

(a) / B37T

12.20
C.R.1037



- 1 - 77 01 005 301
- 2 - 77 01 027 569
- 3 - 77 01 030 712
- 4 - 77 01 030 711
- 5 - 77 01 030 717
- 6 - 77 01 030 263
- 7 - 08 70 426 800
- 8 - 77 01 027 574
- 9 - 77 01 018 638
- 10 - 77 01 027 581
- 11 - 77 01 024 222
- 12 - 77 01 030 706
- 13 - 77 01 027 538
- 14 - 77 01 030 630
- 15 - 77 01 029 475
- 16 - 77 01 027 537
- 17 - 77 01 030 853
- 18 - 77 01 030 860

WEBER D.R.T.



2/100

2C/100

2C/101

12.20
C.R.1037

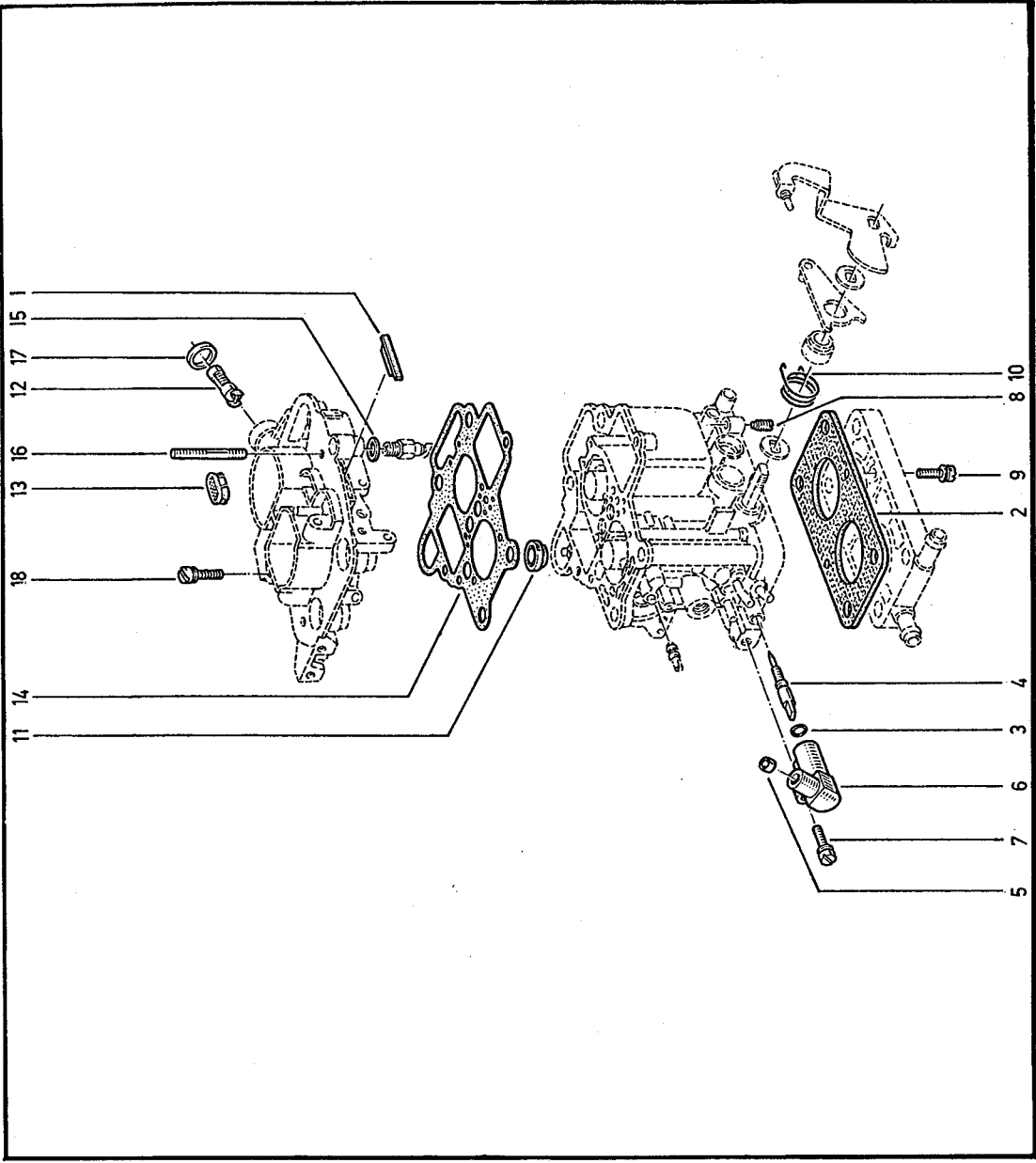

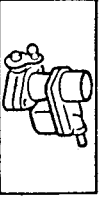

12.22
C.R.1037

- 1 - 77 01 030 845
- 2 - 77 01 018 638
- 3 - 77 01 023 914
- 4 - 77 01 002 851
- 5 - 77 01 019 117
- 6 - 77 02 073 099
- 7 - 77 01 022 156
- 8 - 77 01 020 533 (a)
- 9 - 77 01 027 570 (a)
- 10 - 77 01 026 372 (a)
- 11 - 77 02 088 591 (a)
- 12 - 0117959

WEBER D.R.T



2/100

2C/100

2C/101

12.22
C.R.1037

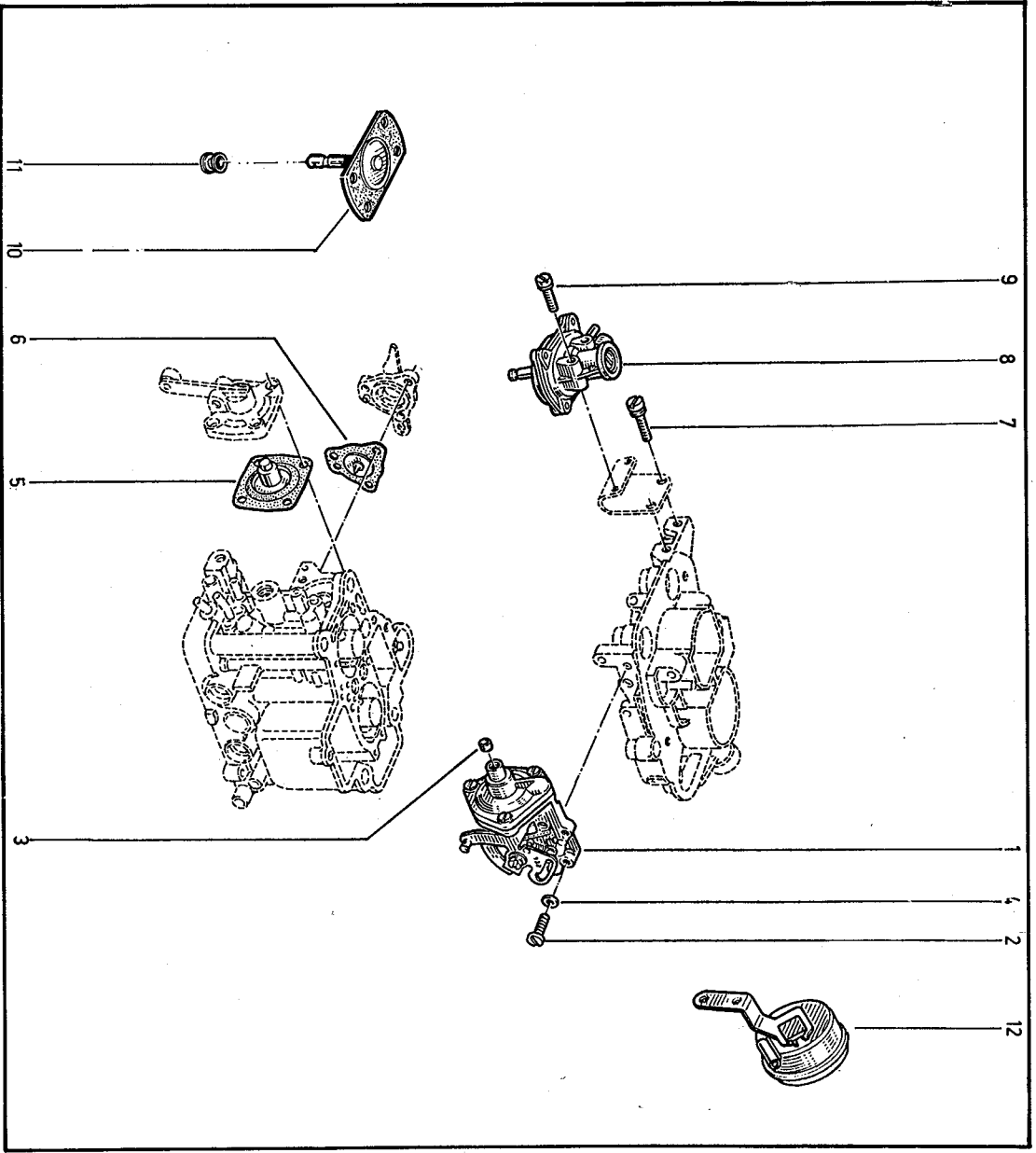
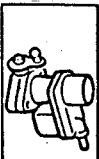

(a) / 2C/100
2C/101

12.24
C.R.1037



- 1 - 77 01 020 677
- 2 - 77 01 030 838
- 3 - 77 01 030 707
- 4 - 77 01 005 315
- 5 - 77 01 027 559
- 6 - 77 01 030 846
- 7 - 77 01 030 847
- 8 - 77 01 030 848
- 9 - 77 01 014 582
- 10 - 08 70 102 605
- 11 - 77 01 030 721
- 12 - 77 01 030 849

WEBER D.R.T.



2/100 2C/100 2C/101

12.24
C.R.1037

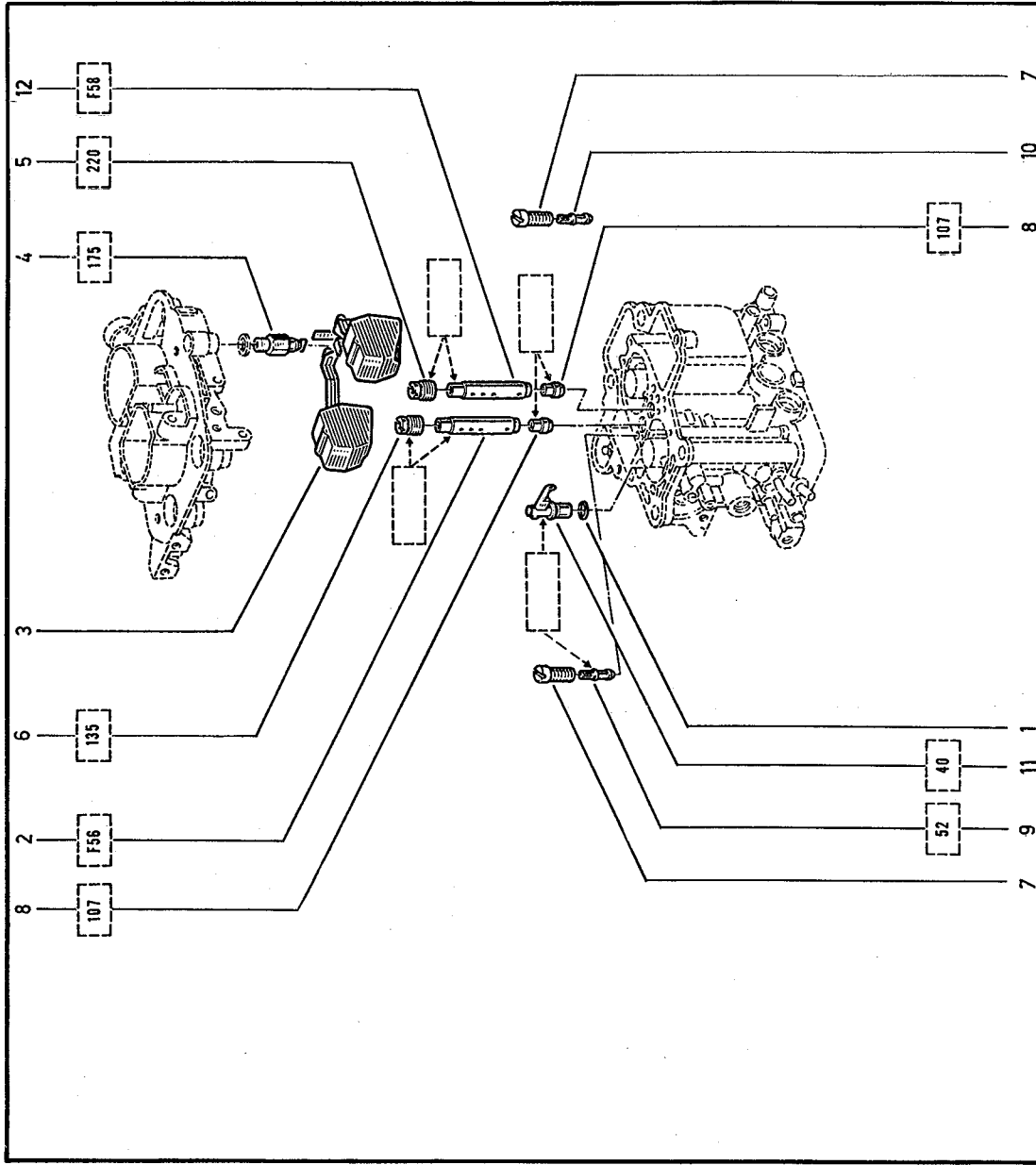
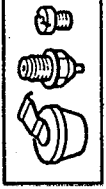

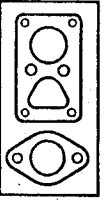

12.26
C.R.1037

1 - 77 01 030 850
2 - 77 01 030 851

WEBER D.R.T



2/100

2C/100

2C/101

12.26
C.R.1037

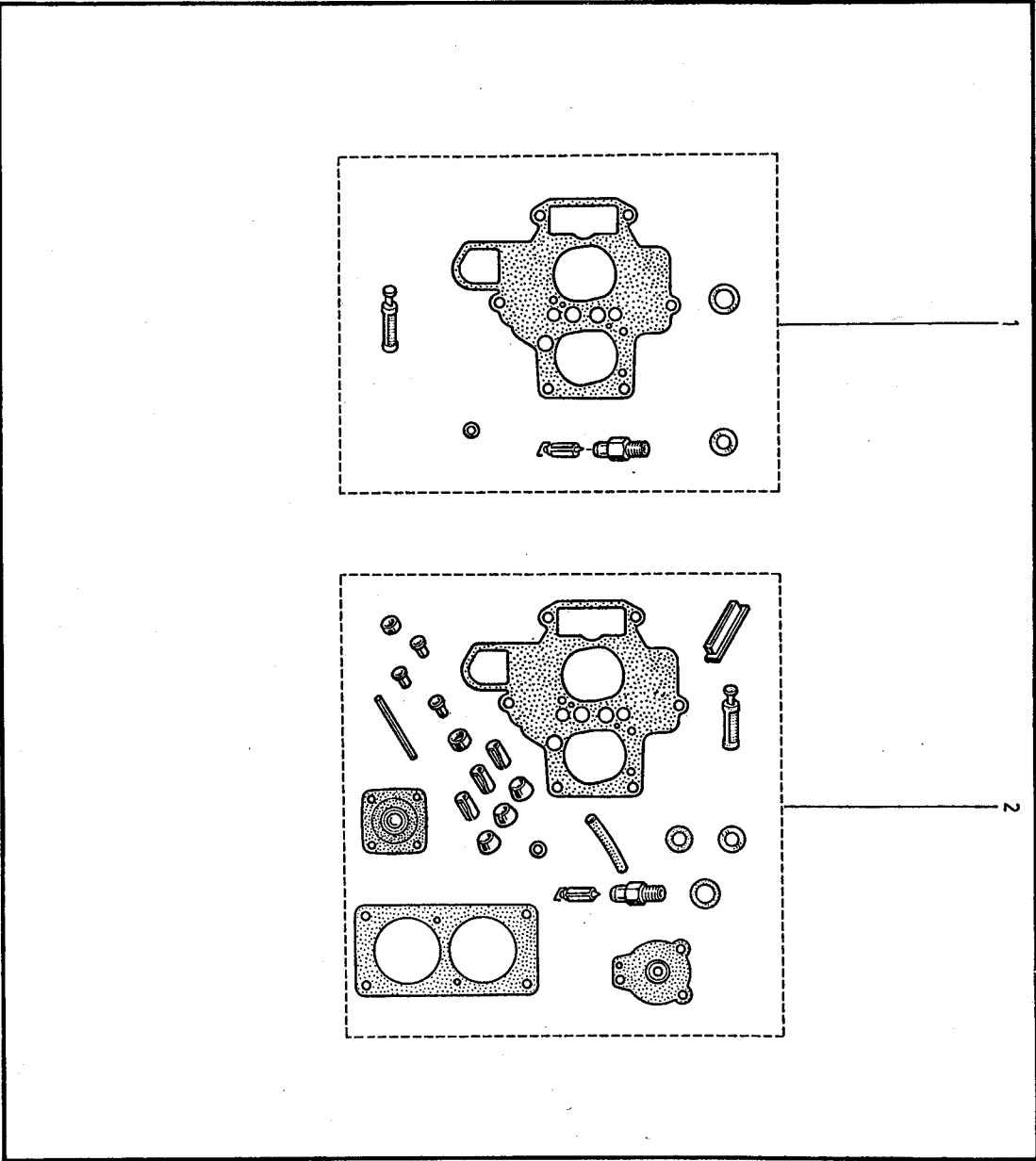
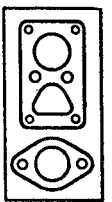



12.31
C.R.1037

B375
SOLEX



12.31
C.R.1037

- 1 - 77 02 080 764
- 2 - 77 01 029 726
- 3 - 77 01 028 002
- 4 - 77 01 031 974
- 5 - 77 01 032 105

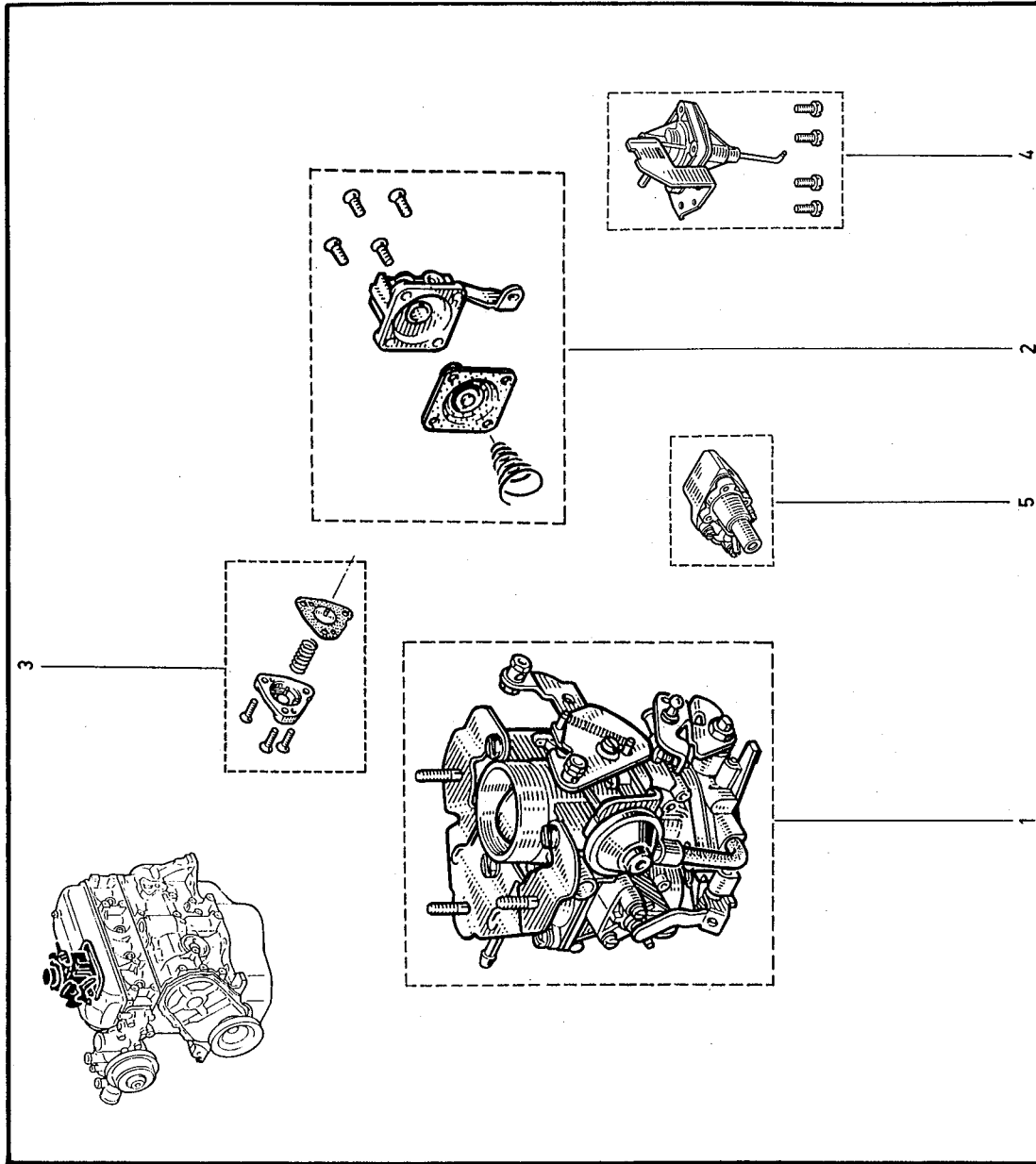

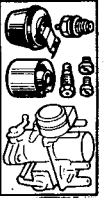

- 1 - 77 01 029 724
- 2 - 77 01 021 821
- 3 - 77 01 200 831
- 4 - 77 01 031 187
- 5 - 77 01 020 186
- 6 - 77 01 031 113
- 7 - 77 01 201 559
- 8 - 77 01 030 450
- 9 - 77 01 023 480
- 10 - 77 01 029 725
- 11 - 77 01 029 632

12.32
C.R.1037

B375
SOLEX

12.32
C.R.1037

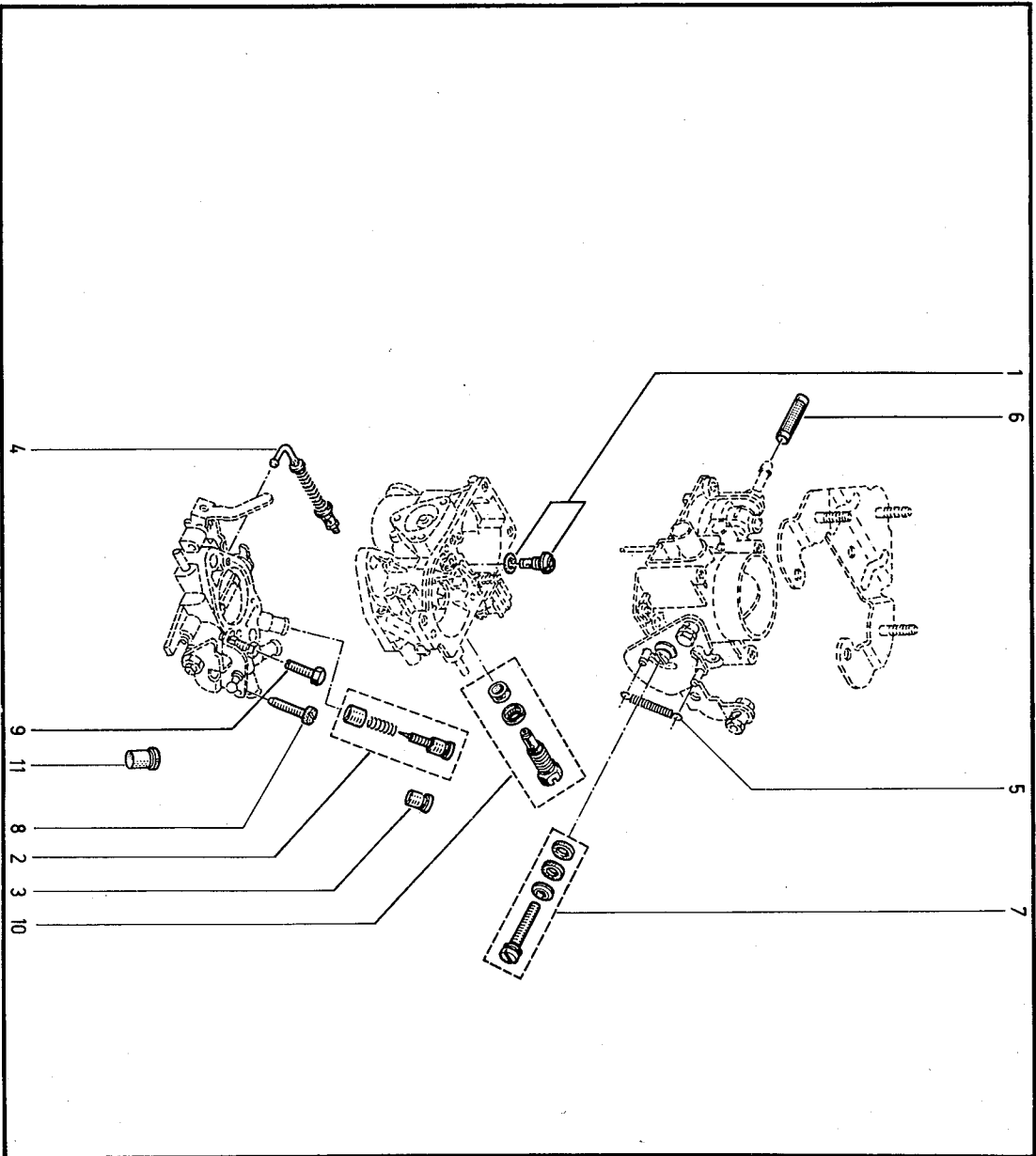
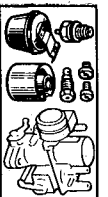

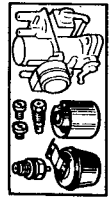

12.33
C.R.1037

B375
SOLEX

12.33
C.R.1037

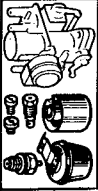

- 1 - 77 01 026 390
- 2 - 77 01 017 580
- 3 - 77 02 080 765
- 4 - 77 01 031 183
- 5 - 77 01 031 184
- 6 - 77 01 031 182
- 7 - 77 01 030 895

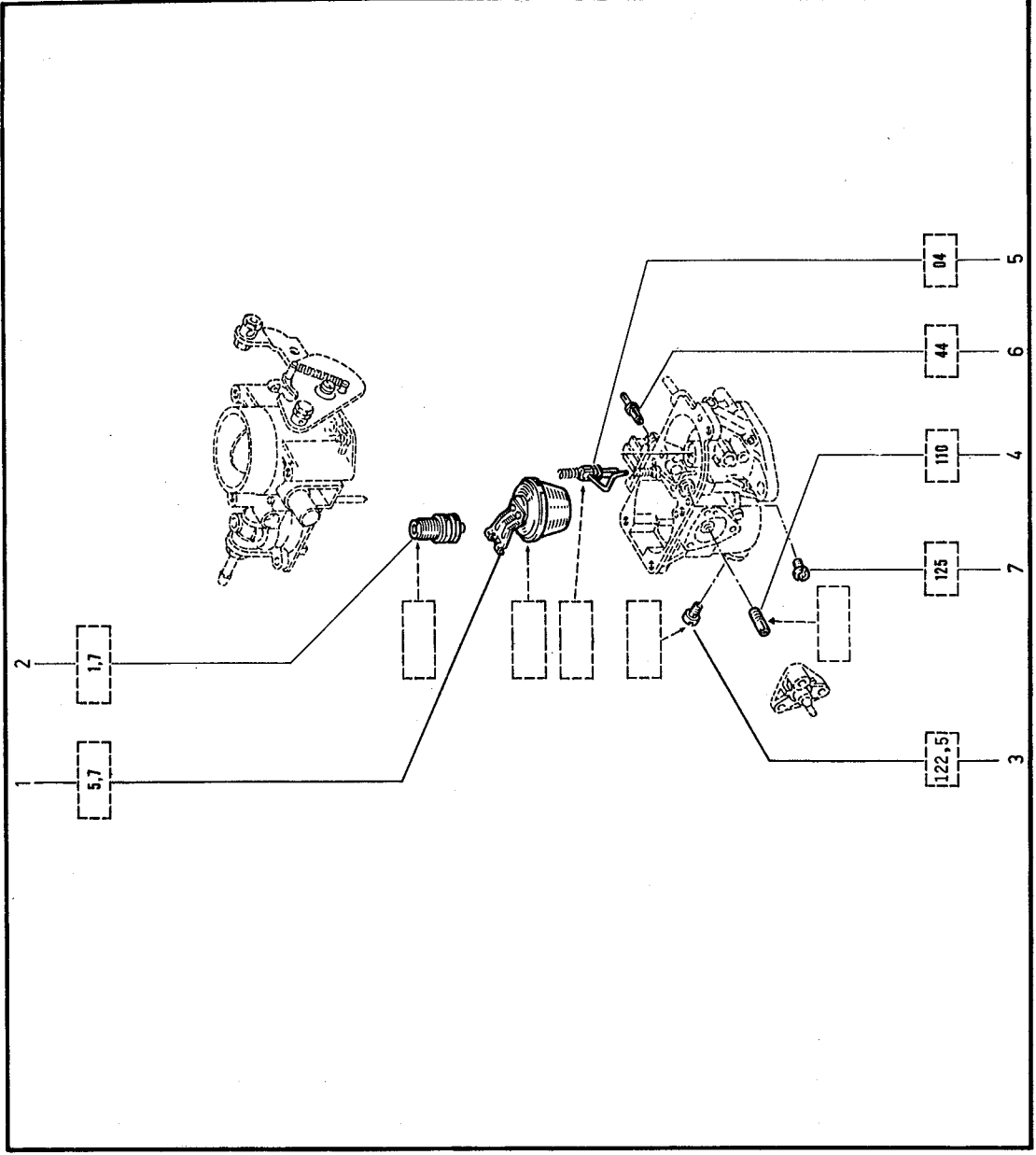



- 1 - 77 01 201 556
- 2 - 77 01 201 557
- 3 - 77 01 201 558

12.34
C.R.1037

B375
SOLEX

12.34
C.R.1037

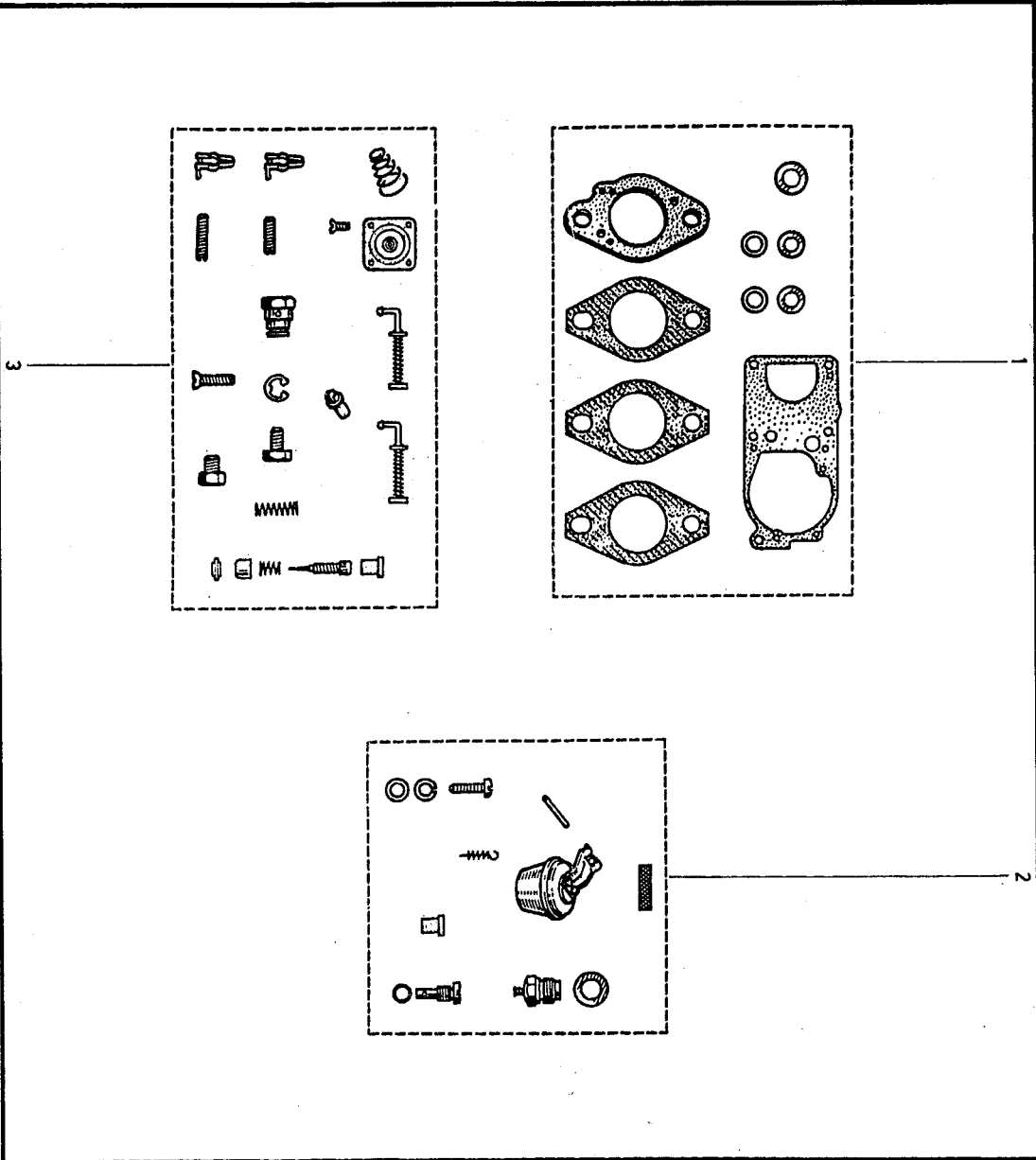



12.50
C.R. 1037

- 1 - 77 00 706 839 (a)
- 60 01 007 412 (B-375)
- 77 00 726 561 (a)
- 2 - 77 00 706 840 (a)
- 3 - 77 00 707 106 (b)
- 77 00 726 562 (b)
- 4 - 77 00 707 107 (b)
- 5 - 77 02 056 693
- 6 - 77 02 056 692
- 7 - 60 01 007 413 (B-375)
- 8 - 77 02 056 975



12.50
C.R. 1037

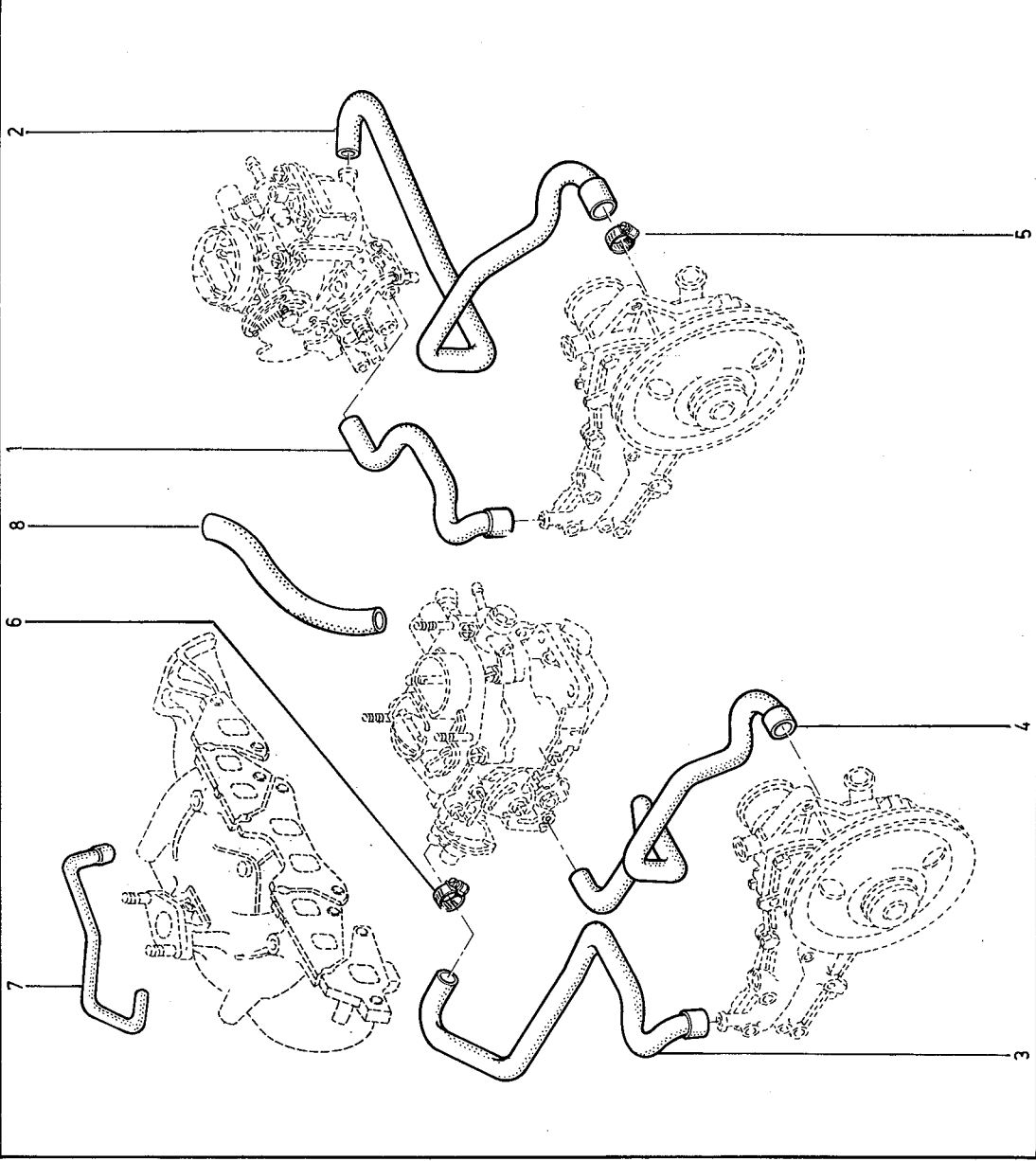

(a) / B372
(b) / B373 B37T



12.55
C.R. 1037

- 1 - 60 01 008 157
- 2 - 77 02 080 758
- 3 - 77 00 757 236
- 4 - 77 02 080 759
- 5 - 77 02 080 766

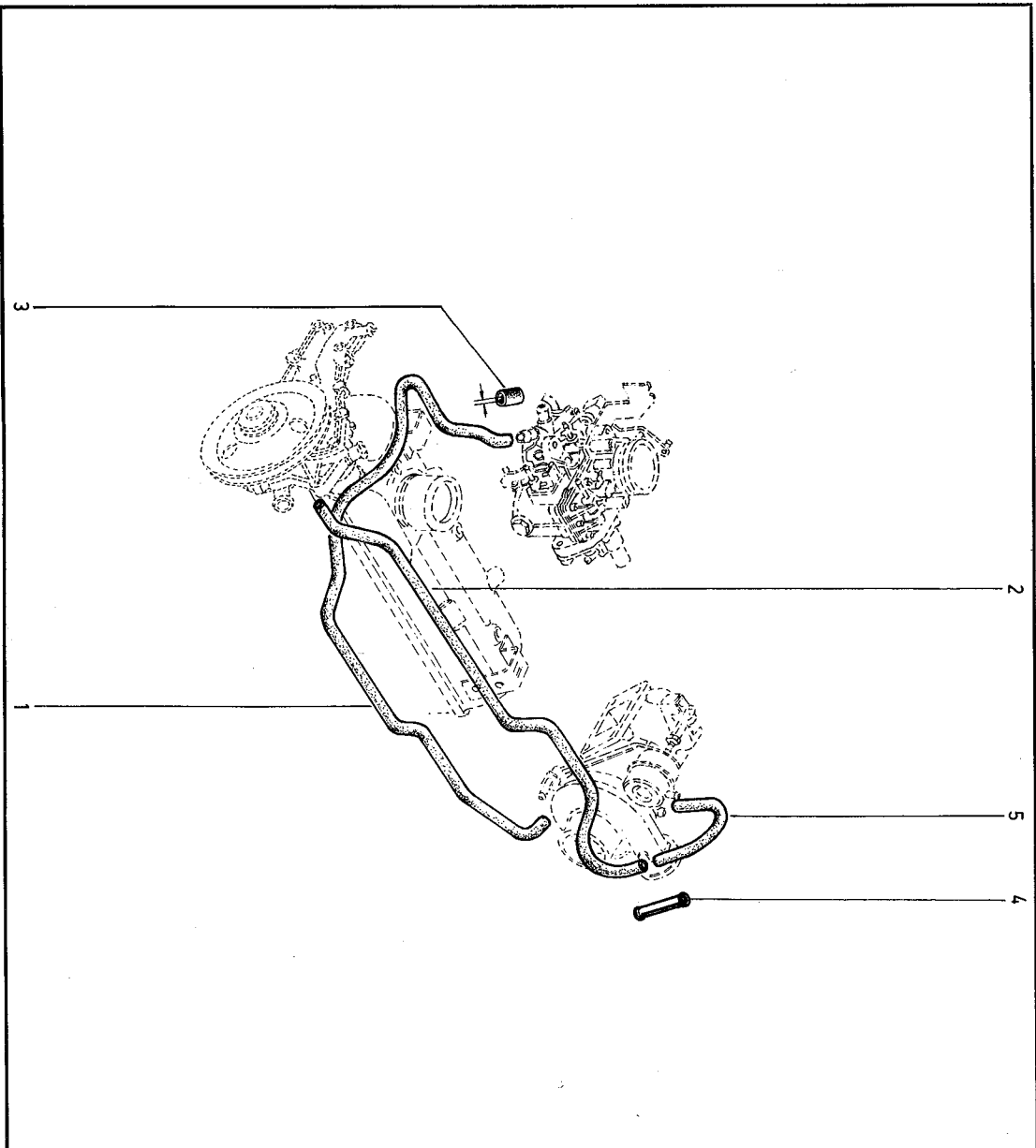

12.55
C.R. 1037



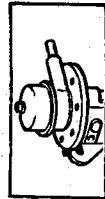

13.01
C.R.1037

- 1 - 77 01 349 266 †
- 77 02 080 696 †
- 77 02 080 694
- 2 - 77 01 642 468
- 3 - 79 03 032 018
- 4 - 77 03 055 011
- 5 - 79 03 053 043
- 6 - 77 02 073 147
- 7 - 77 02 073 987
- 8 - 77 02 023 292
- 9 - 77 90 672 090
- 10 - 77 02 057 895
- 11 - 77 02 057 894
- 12 - 77 02 080 695
- 13 - 77 02 080 697 (a)
- 14 - 77 02 080 689

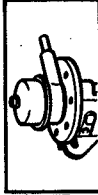

13.01
C.R.1037

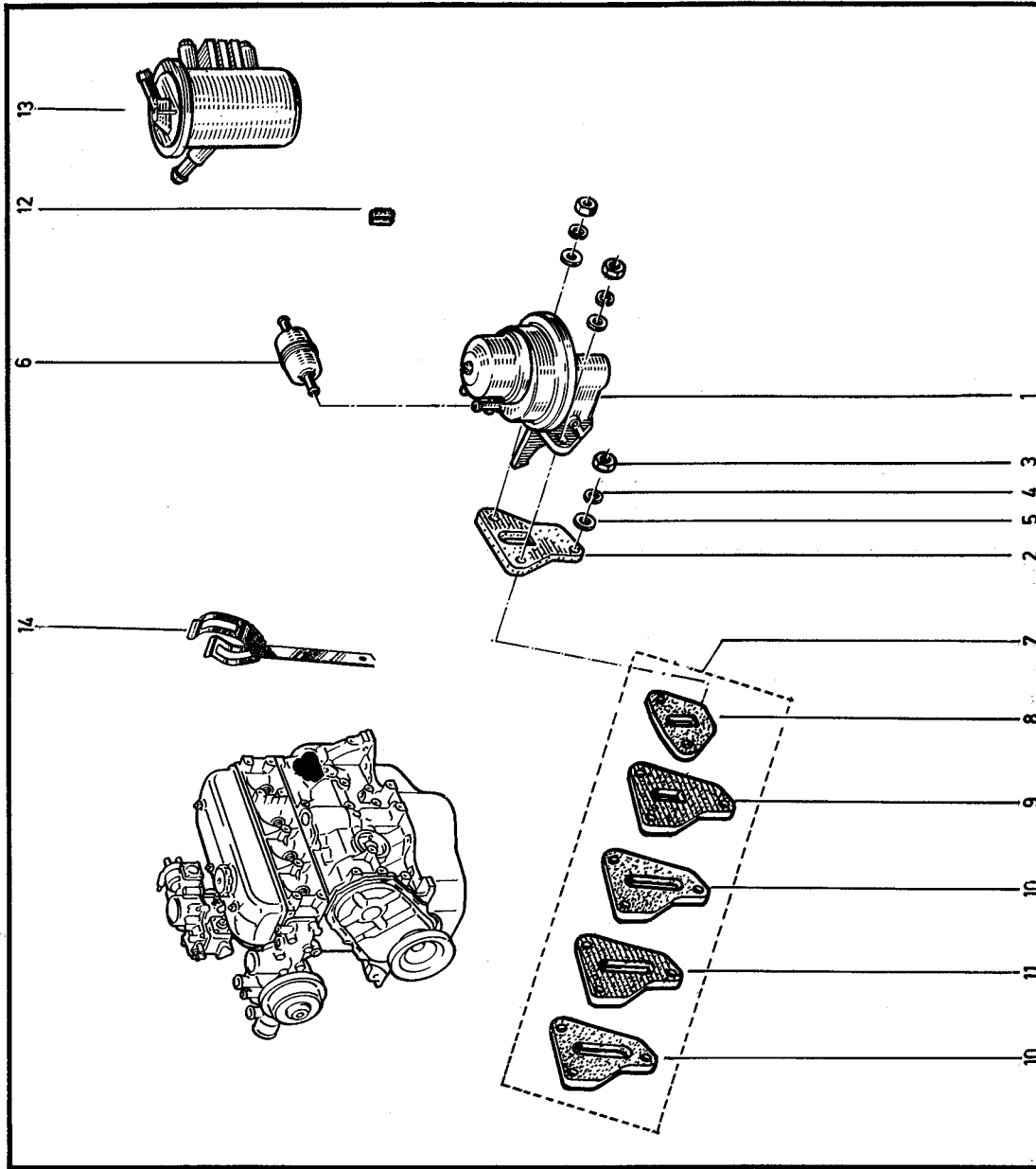

(a) / B372 n° 02233 n°
B373 n° 04834 n°



13.03
C.R.1037

- 1 - 80 01 008 001
- 2 - 77 04 001 666
- 3 - 77 00 676 262
- 4 - 77 03 019 087
- 77 03 001 074
- 5 - 77 00 680 167
- 6 - 77 00 757 549
- 7 - 77 00 757 547
- 8 - 77 00 771 720
- 9 - 77 03 073 181
- 10 - 77 05 001 262
- 11 - 77 03 073 105
- 12 - 77 03 019 012
- 14 - 77 05 001 032

B375

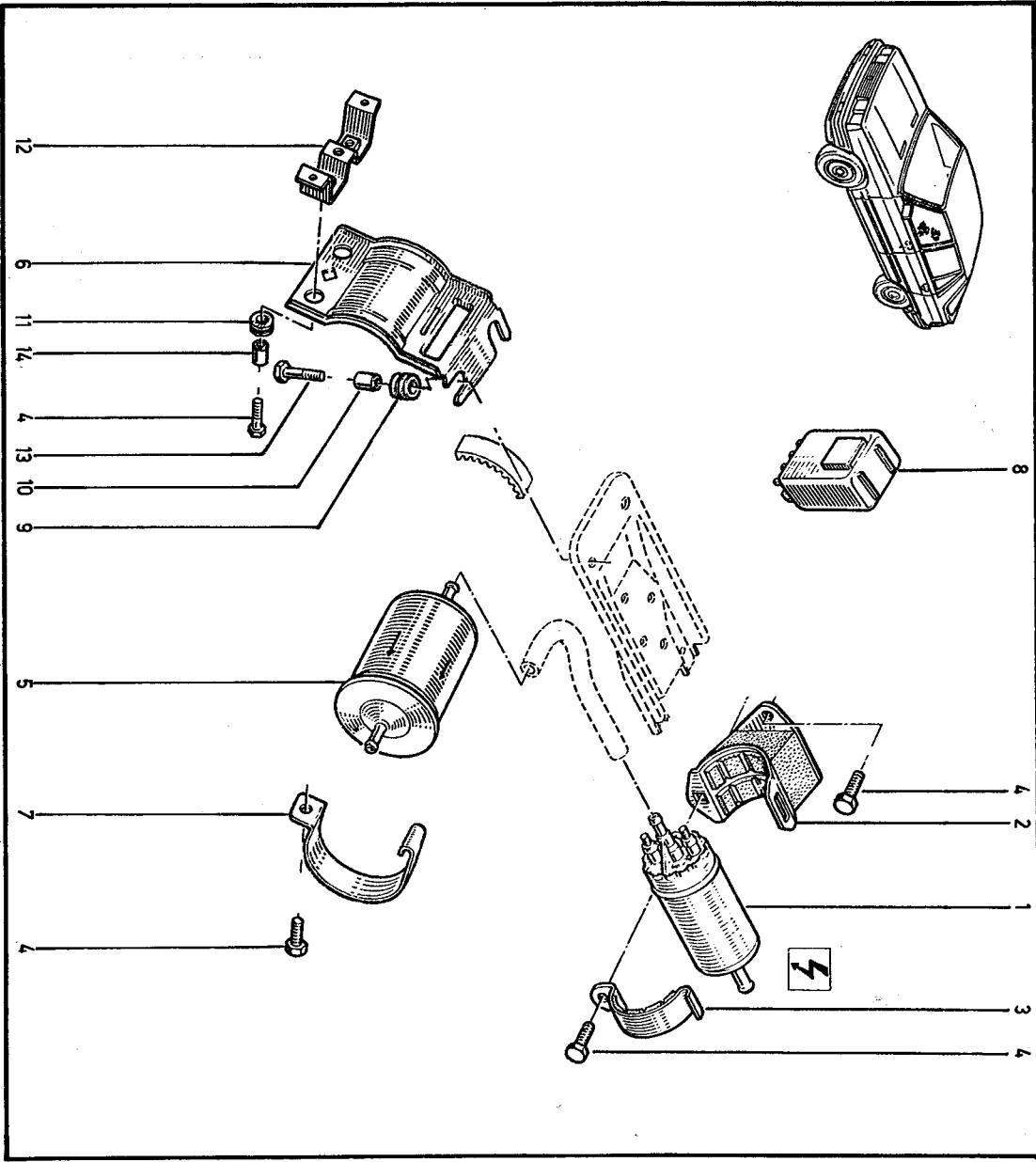

13.03
C.R.1037





13.04
C.R.1037



13.04
C.R.1037

B375

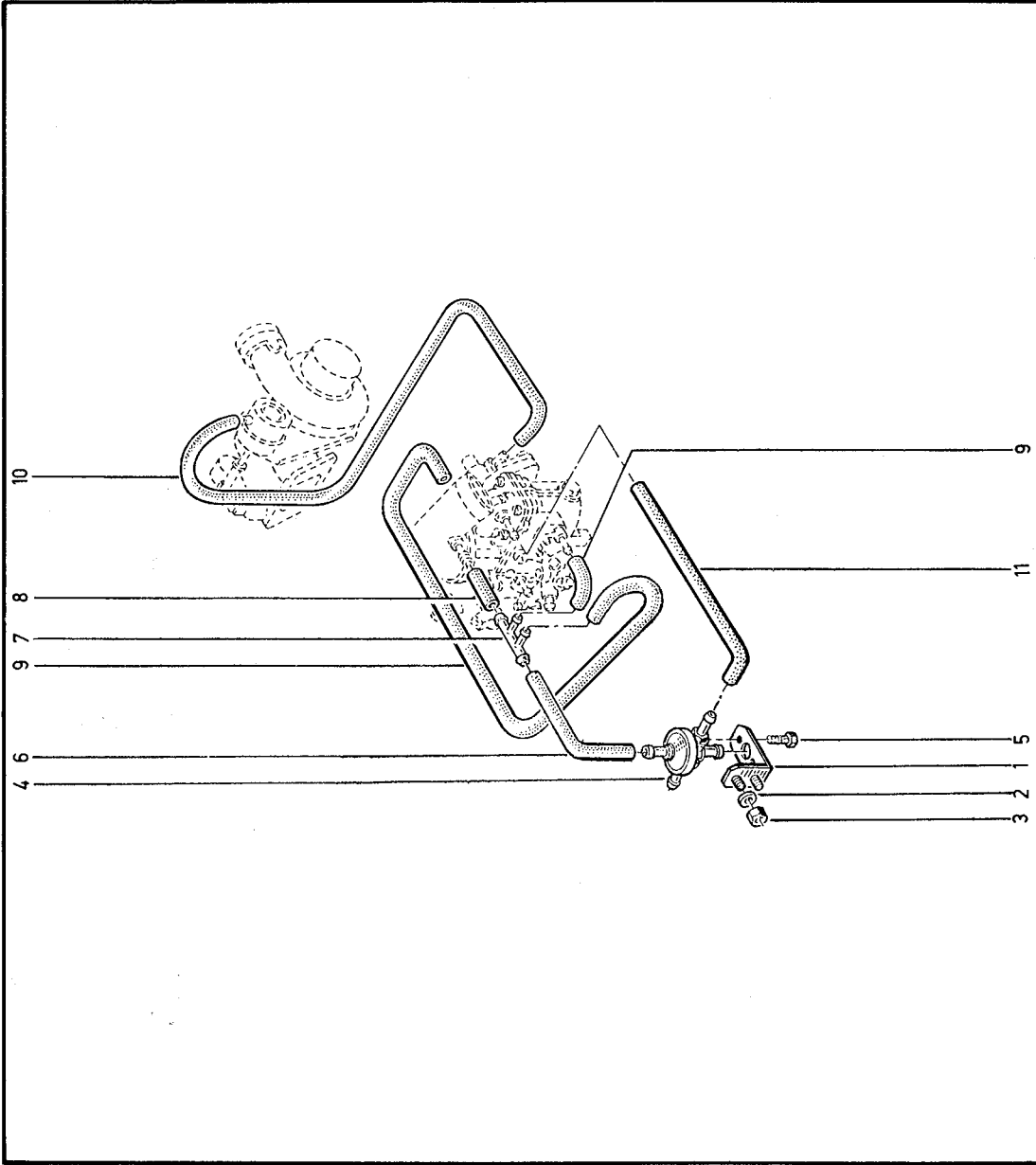

- 1 - 77 00 687 437
- 2 - 77 03 055 005
- 3 - 77 02 074 047
- 4 - 77 00 684 429
- 5 - 77 03 001 008
- 6 - 60 01 005 905
- 7 - 77 05 030 085
- 8 - 77 05 026 248 \leq 1m. †
- 77 01 033 227 \leq 1m.
- 9 - 60 01 005 906
- 10 - 60 01 004 977
- 11 - 60 01 005 958

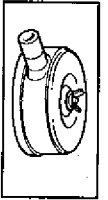

13.20
C.R.1037

- 1 - 77 00 691 805 (a)
77 01 349 617 (a)
77 01 349 632 (b) +
77 00 726 615 (b) +
77 00 732 100 (b)
- 2 - 77 01 349 530
- 3 - 77 02 088 594

(a) / B-372
(b) / B-373

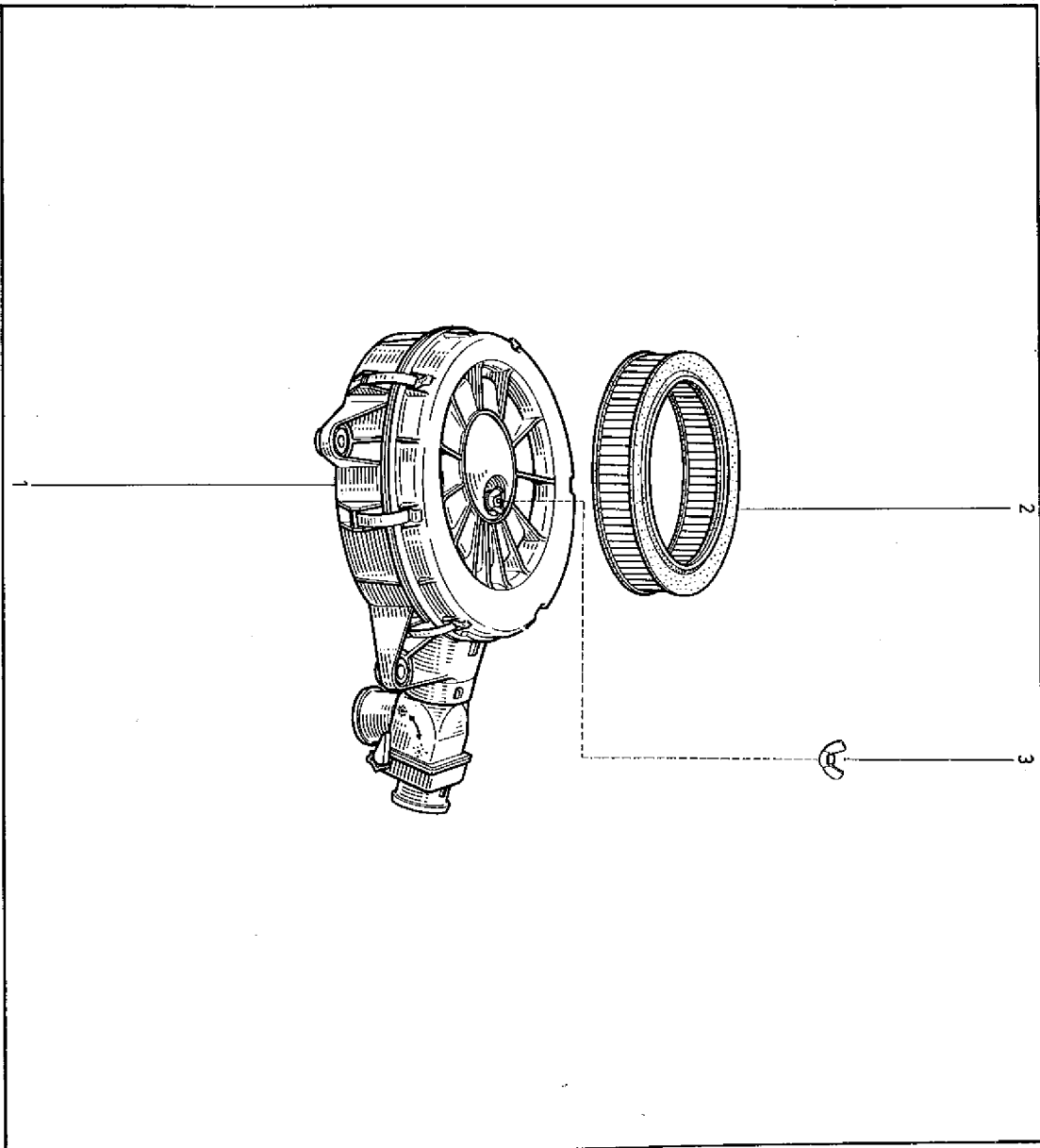

13.20
C.R.1037

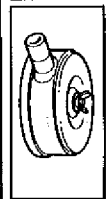



13.24
C.R.1037

- 1 - 60 01 008 160
- 2 - 60 01 004 091
- 3 - 77 03 088 033
- 4 - 77 00 589 318
- 5 - 60 01 004 092
- 6 - 60 01 004 096
- 7 - 60 01 004 094
- 8 - 77 03 001 158
- 9 - 79 03 053 043
- 10 - 77 03 032 047
- 11 - 77 01 348 115



13.24
C.R.1037

B375

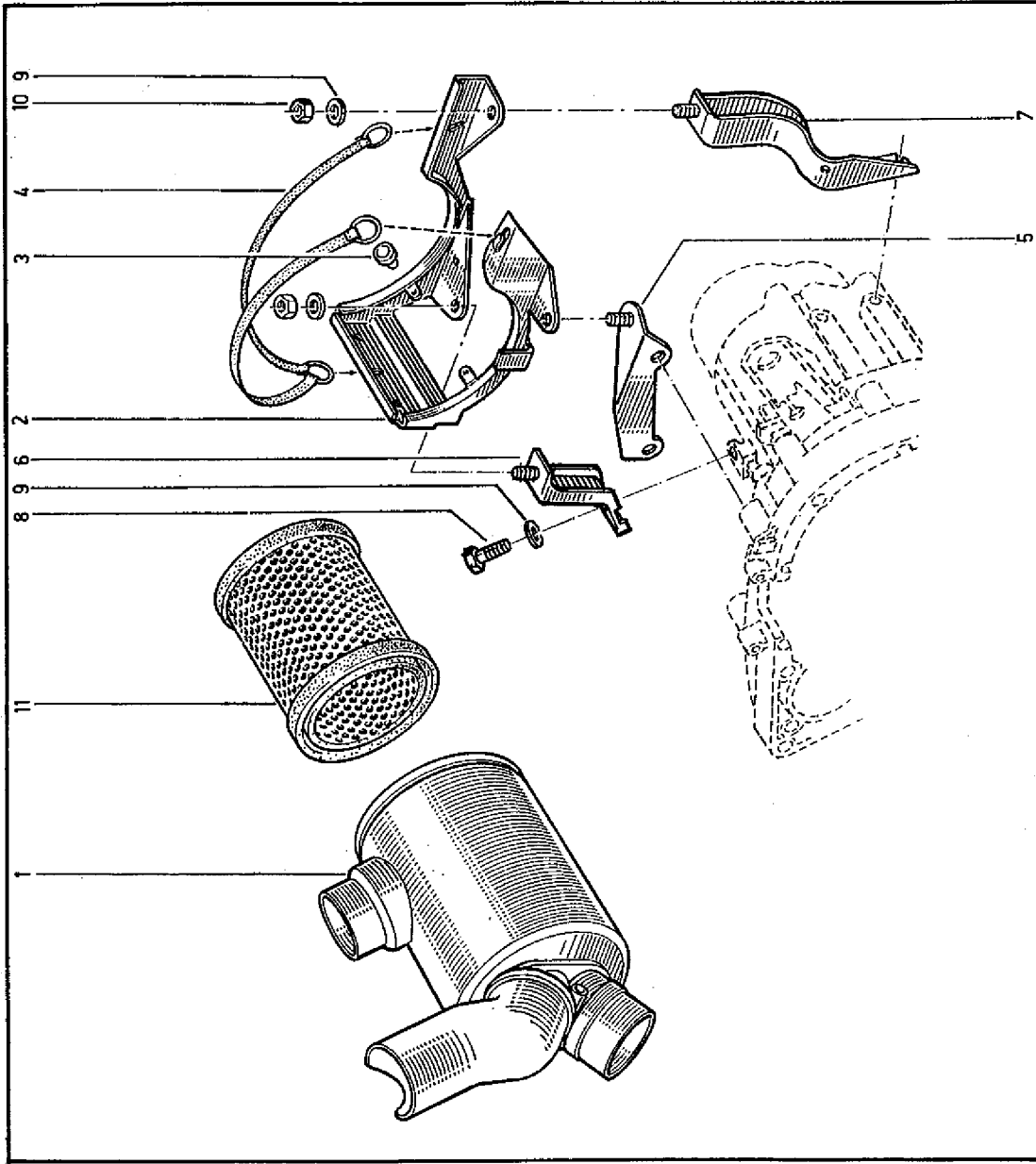

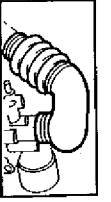

13.28
C.R.1037

- 1 - 77 00 708 747
- 2 - 77 03 001 118
- 3 - 79 03 056 037
- 4 - 77 00 678 888
- 5 - 77 00 693 946
- 6 - 79 03 056 014
- 7 - 79 03 032 018
- 8 - 77 04 001 305 +
- 77 02 080 683
- 9 - 77 04 001 372
- 10 - 79 03 053 031
- 11 - 77 03 001 120
- 77 03 016 264
- 12 - 77 03 053 295
- 13 - 77 05 001 011
- 14 - 77 03 055 007
- 15 - 79 03 032 009
- 16 - 990099500

B372

13.28
C.R.1037

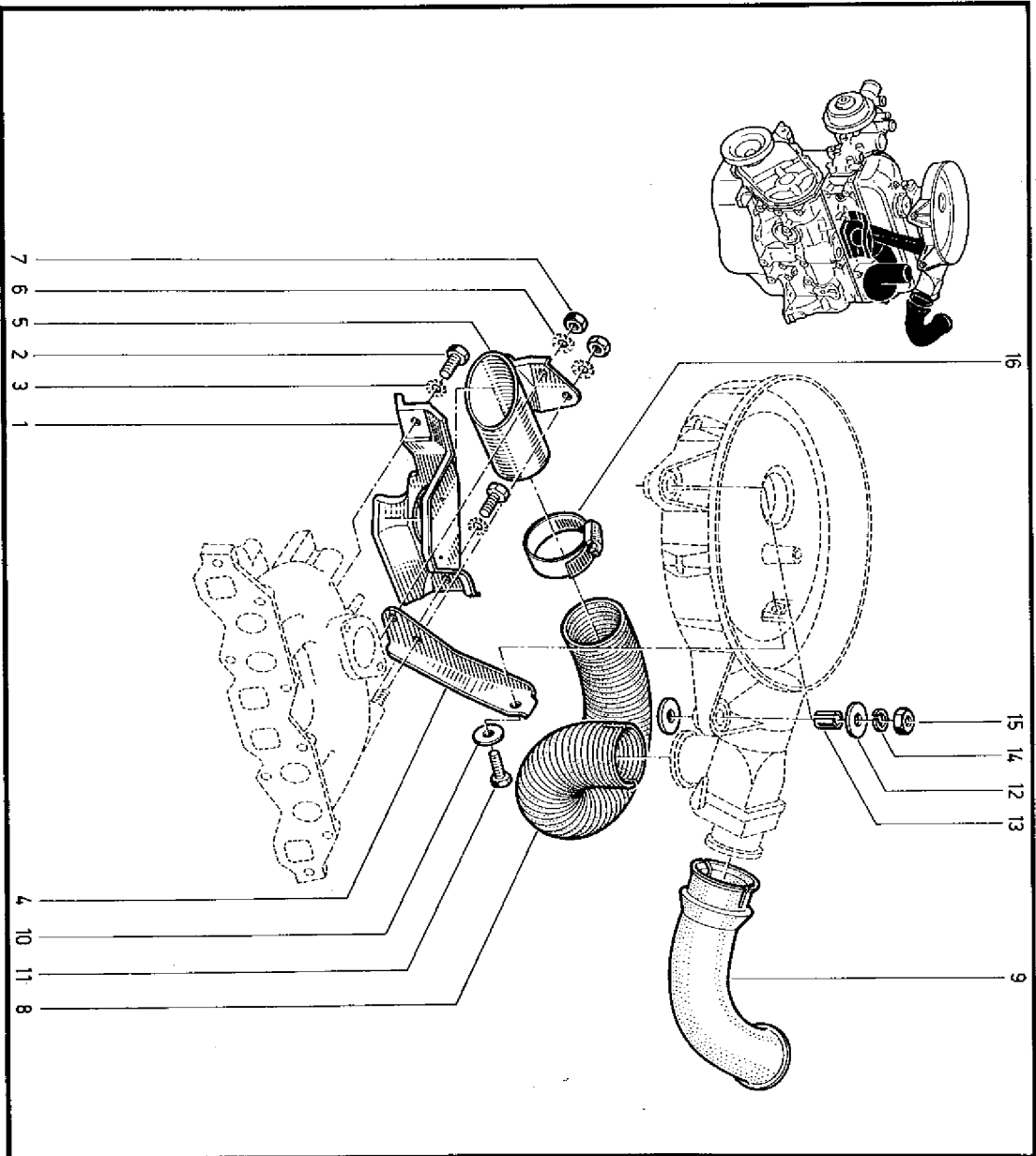

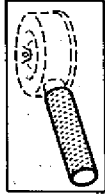

13.30
C.R.1037

- 1 - 77 00 707 261
- 2 - 77 03 001 118
- 3 - 79 03 056 037
- 4 - 77 04 001 698 +
- 5 - 77 02 080 684
- 6 - 77 04 001 372
- 7 - 79 03 032 009 (x = 6)
- 8 - 77 03 053 295
- 9 - 77 05 001 011
- 10 - 77 03 055 007
- 11 - 79 03 032 009
- 12 - 77 00 715 684
- 13 - 9900095
- 14 - 77 03 055 007



13.30
C.R.1037

B373

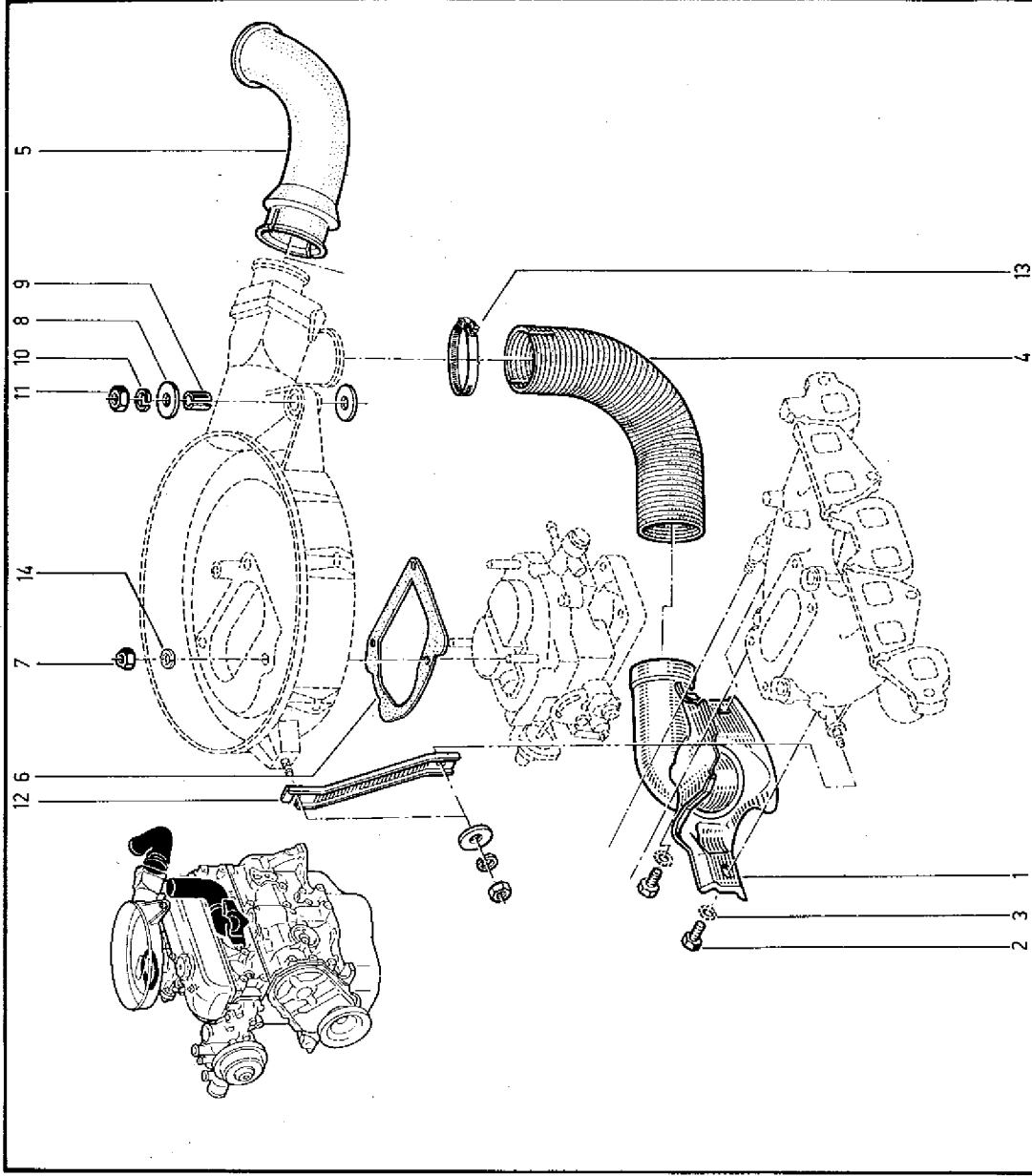

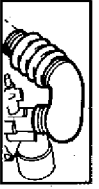

- 1 - 60 01 006 809
- 2 - 77 00 567 500
- 3 - 77 00 765 076

13.31
C.R.1037

B375

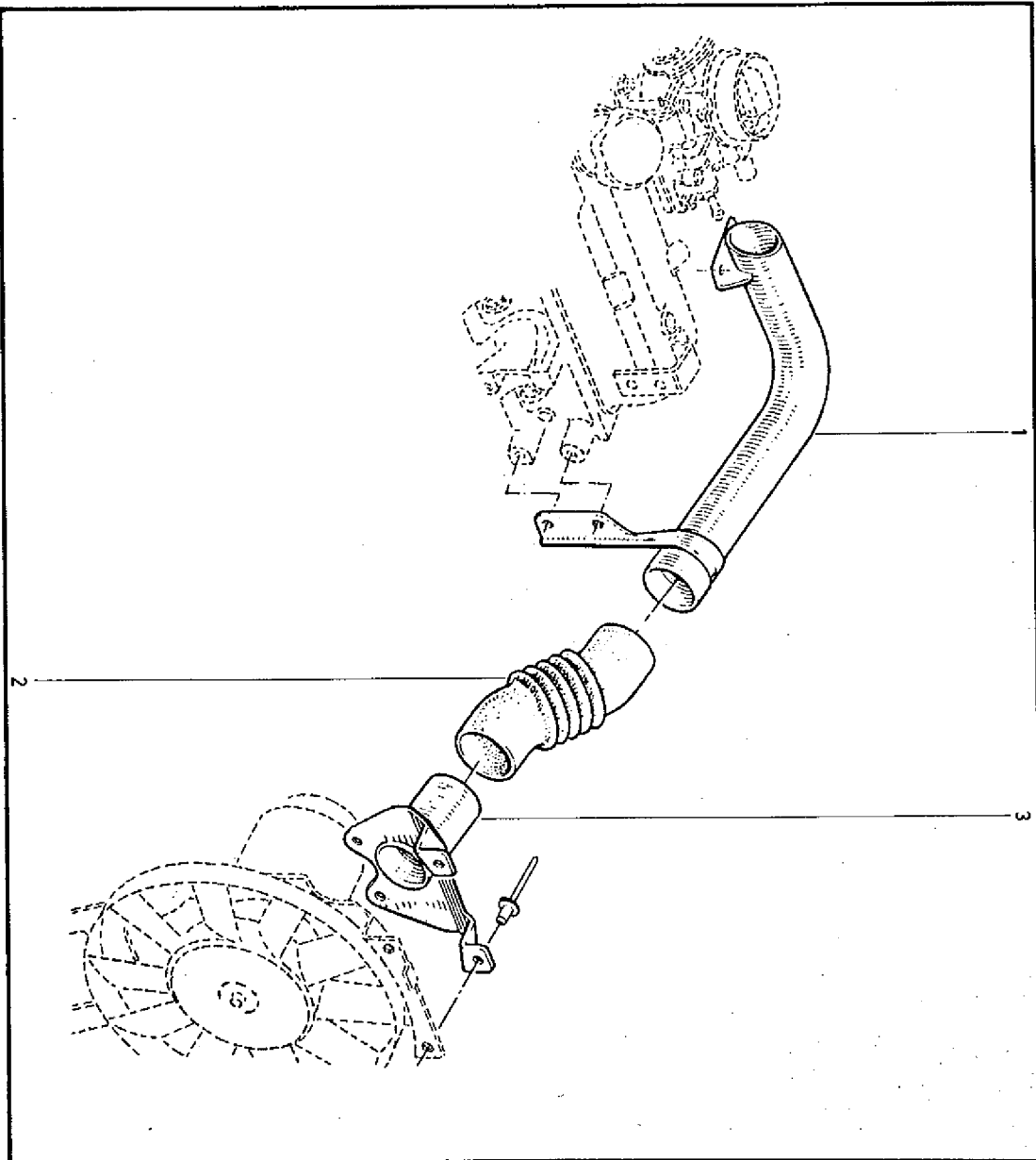

13.31
C.R.1037

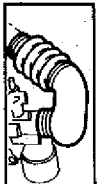

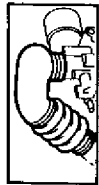

13.35
C.R.1037

- 1 - 60 01 007 477
- 2 - 77 00 717 122
- 3 - 60 01 005 924
- 4 - 60 01 005 925
- 5 - 60 01 004 963
- 6 - 60 01 004 043
- 7 - 60 01 005 982
- 8 - 77 03 027 215
- 9 - 77 03 065 152
- 10 - 77 03 083 219
- 11 - 77 00 750 211

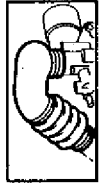

13.35
C.R.1037

B375

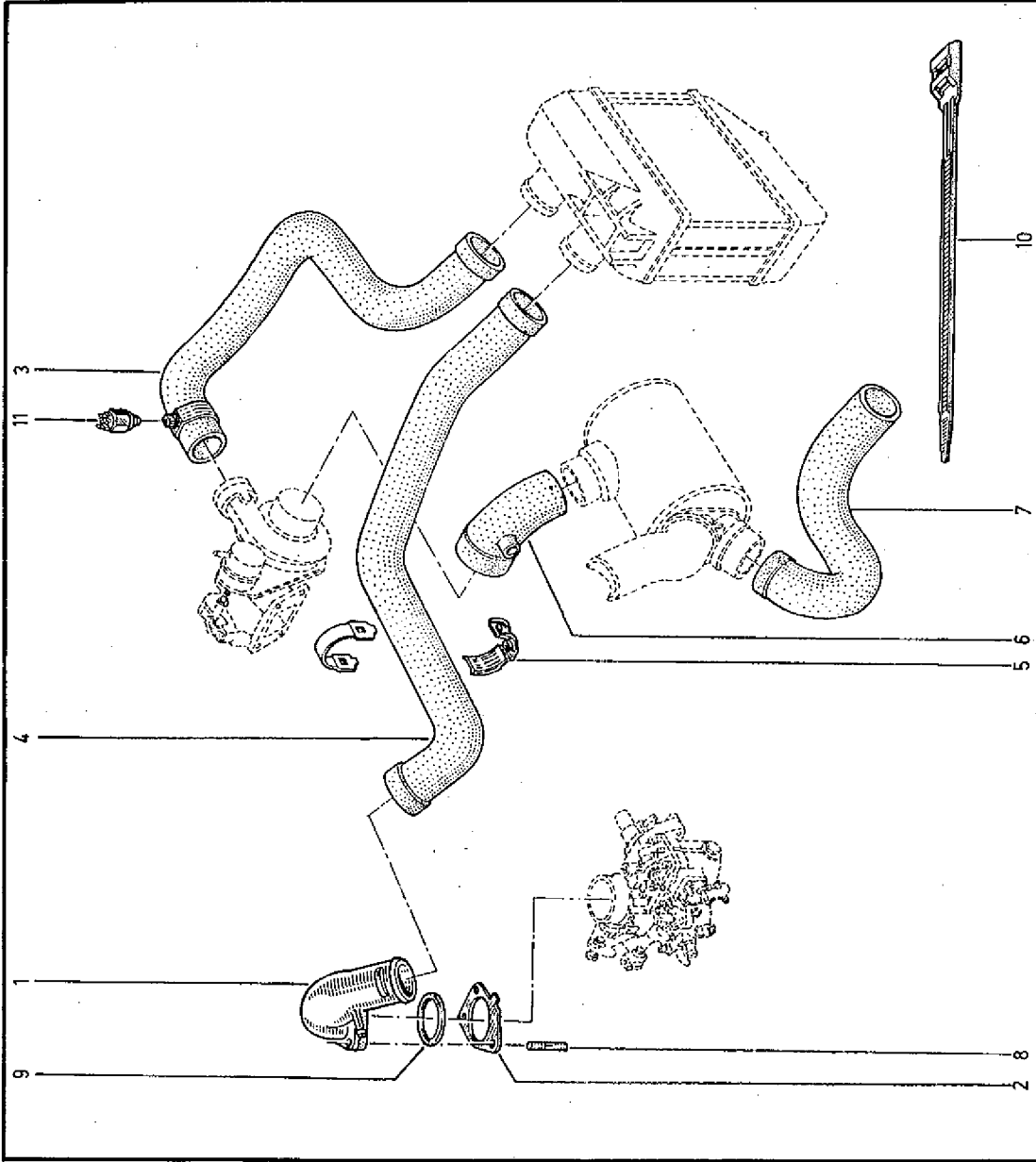



1 - 77 00 678 777
2 - 77 05 030 062
3 - 77 00 678 778

13.40
C.R.1037

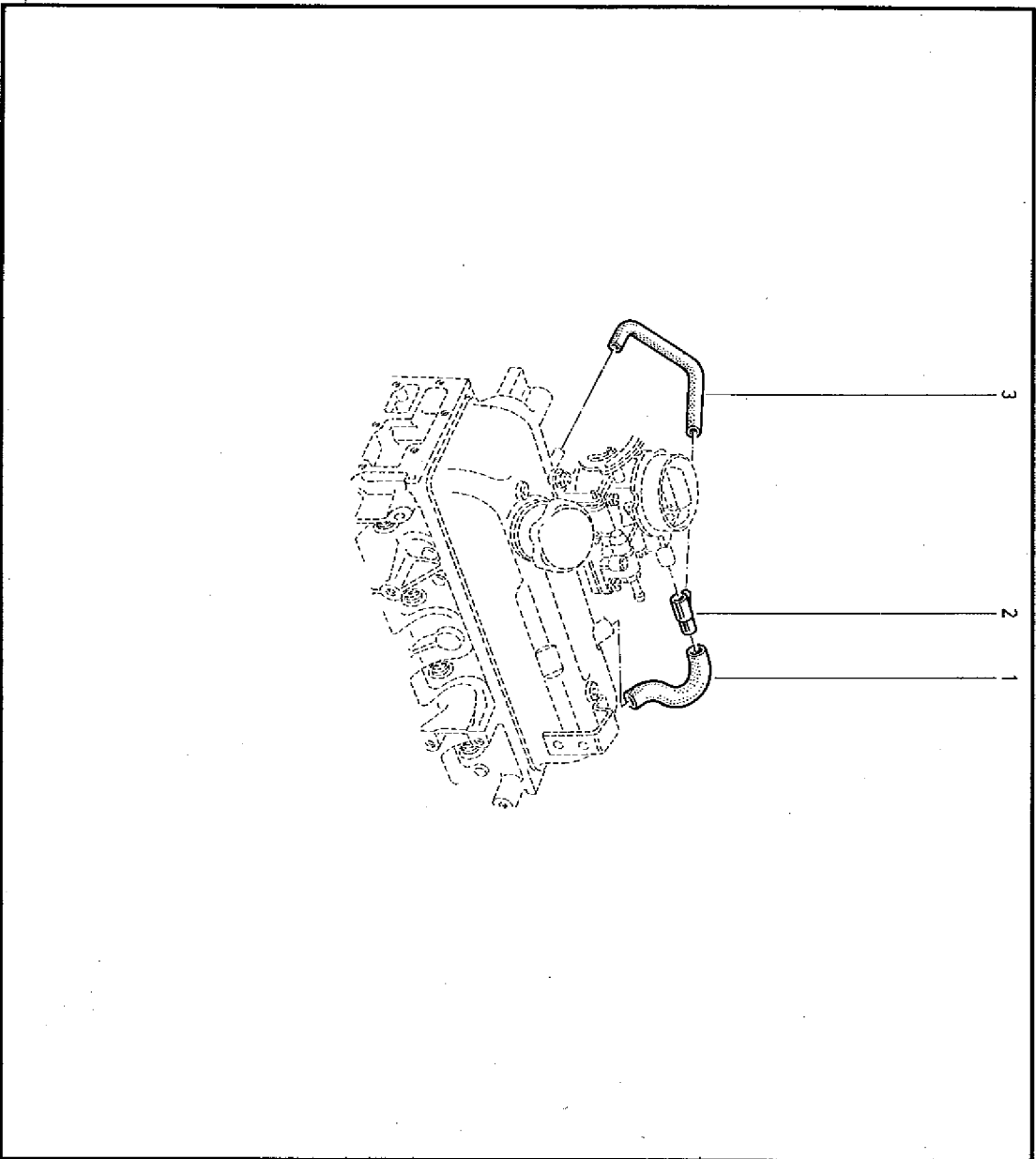

B372

13.40
C.R.1037





13.42
C.R.1037

- 1 - 77 02 080 732
- 2 - 77 00 671 600
- 3 - 77 05 030 070
- 4 - 60 01 003 034
- 5 - 60 01 004 983
- 6 - 77 05 030 007



13.42
C.R.1037

B375

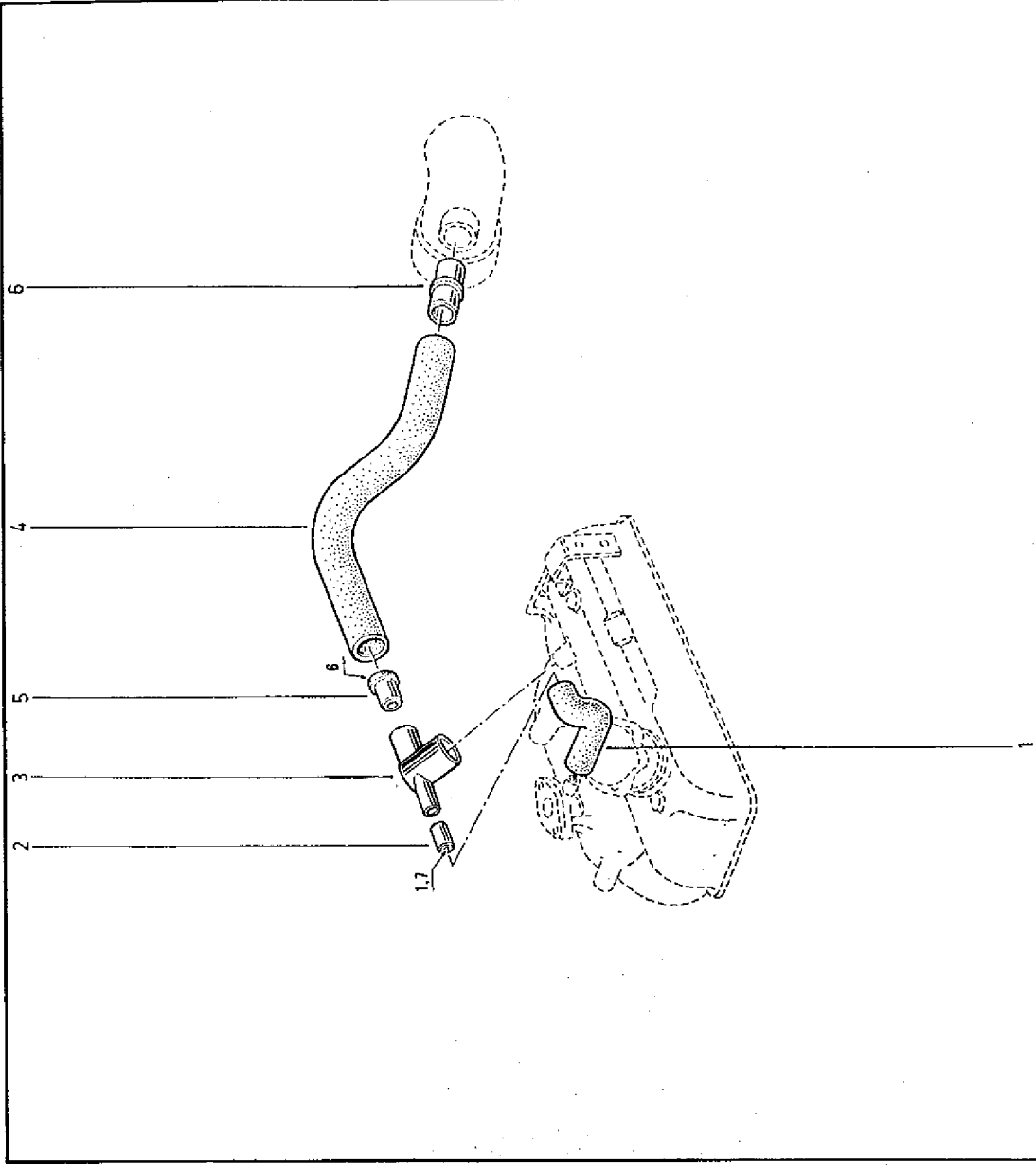



- 1 - 77 05 030 070
- 2 - 77 00 679 144
- 3 - 77 00 538 274
- 4 - 77 00 714 974

13.45
C.R.1037

B373

13.45
C.R.1037

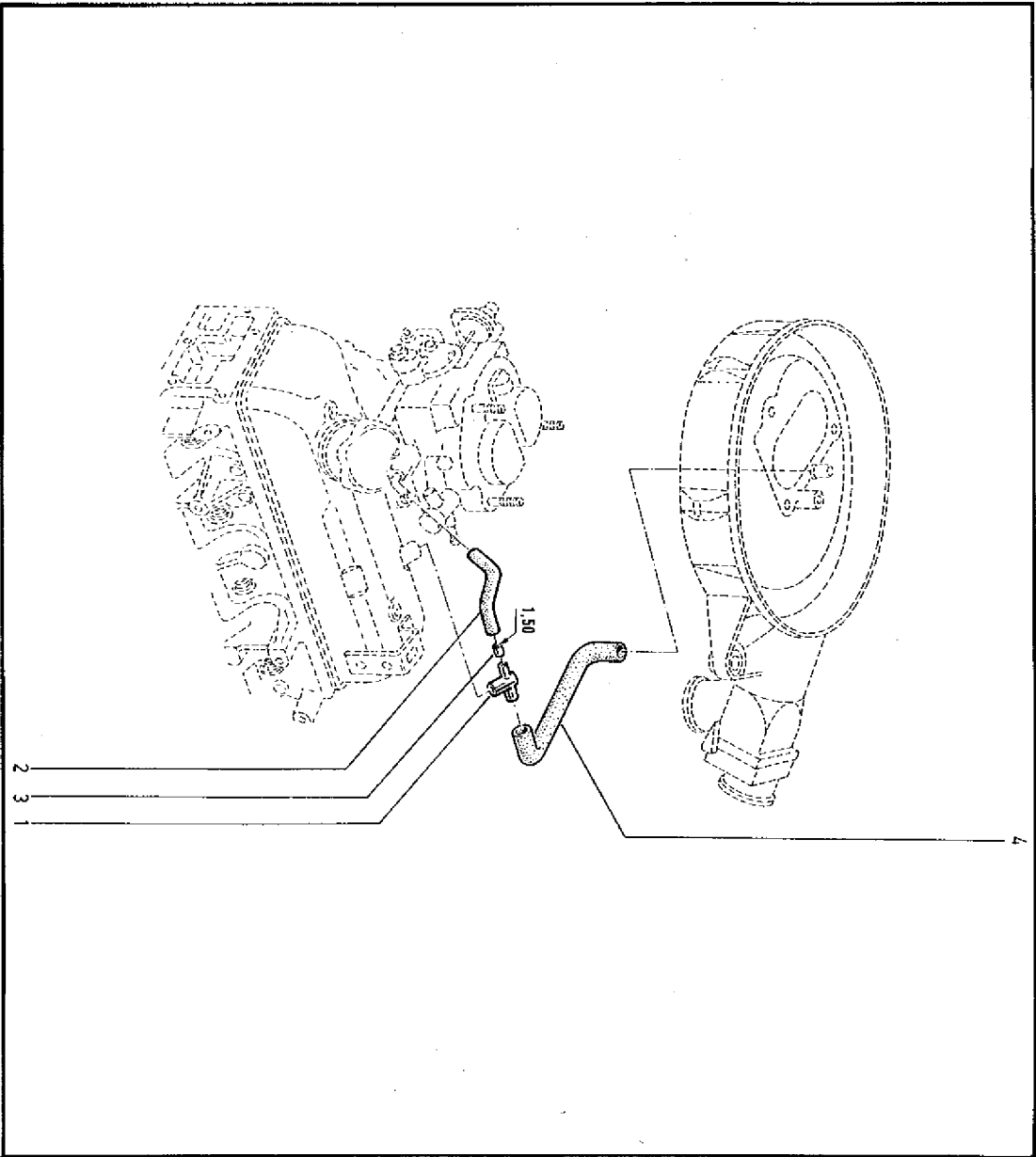



13.80
C.R.1037

- 1 - 77 02 089 333
- 2 - 77 02 093 865
- 3 - 89 33 000 002
- 4 - 89 33 000 964
- 5 - 77 02 080 785
- 77 02 080 786
- 6 - 77 03 001 158 (x = 16)
- 7 - 77 02 057 041
- 8 - 79 03 056 046
- 9 - 77 00 612 542
- 10 - 77 00 512 555
- 11 - 77 03 001 160 (x = 20)
- 12 - 77 03 001 164 (x = 30)
- 13 - 77 03 001 190 (x = 60)
- 14 - 77 03 055 011
- 15 - 77 03 001 750 (x = 117)
- 16 - 79 03 053 043
- 17 - 77 03 101 068 (x = 25)
- 18 - 79 03 032 018
- 19 - 89 33 000 662
- 20 - 77 03 053 037
- 21 - 77 03 055 013
- 22 - 77 00 509 432
- 23 - 77 03 101 046 (x = 30)
- 24 - 79 03 053 050
- 25 - 77 02 080 777
- 26 - 77 03 032 101



13.80
C.R.1037

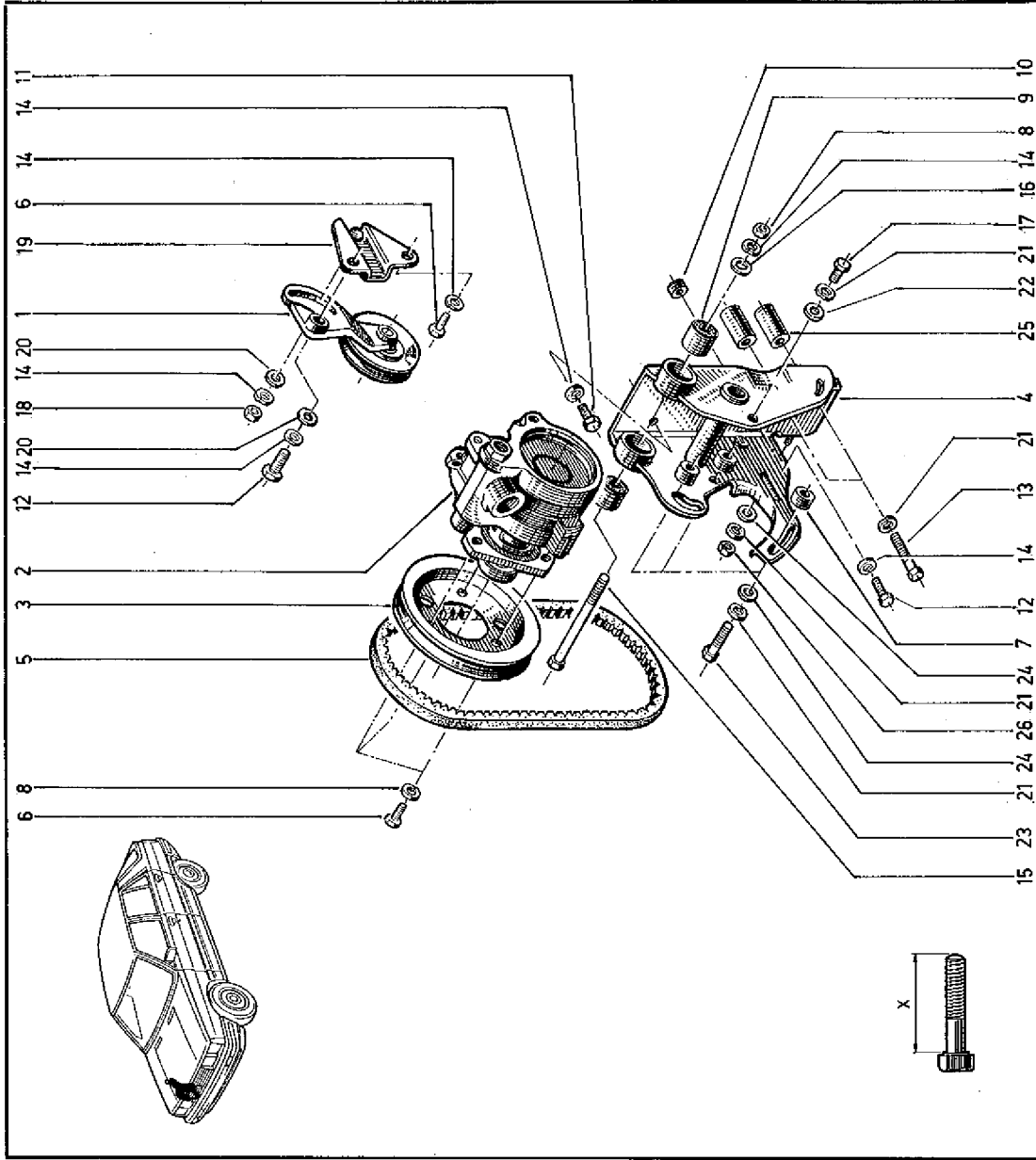

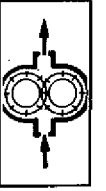

13.81
C.R.1037

- 1 - 89 32 000 642
- 2 - 77 02 083 878
- 3 - 77 02 089 332
- 4 - 77 02 089 331
- 5 - 77 02 093 864
- 6 - 77 02 093 860
- 7 - 77 03 101 042
- 8 - 77 04 001 432
- 9 - 77 00 764 523
- 10 - 77 00 715 482
- 11 - 89 32 001 213
- 12 - 9900091
- 13 - 9900090
- 14 - 89 32 001 074
- 15 - 89 32 000 644
- 16 - 77 03 079 131
- 17 - 77 04 001 604
- 18 - 77 02 089 335
- 19 - 77 02 089 336
- 20 - 2062582

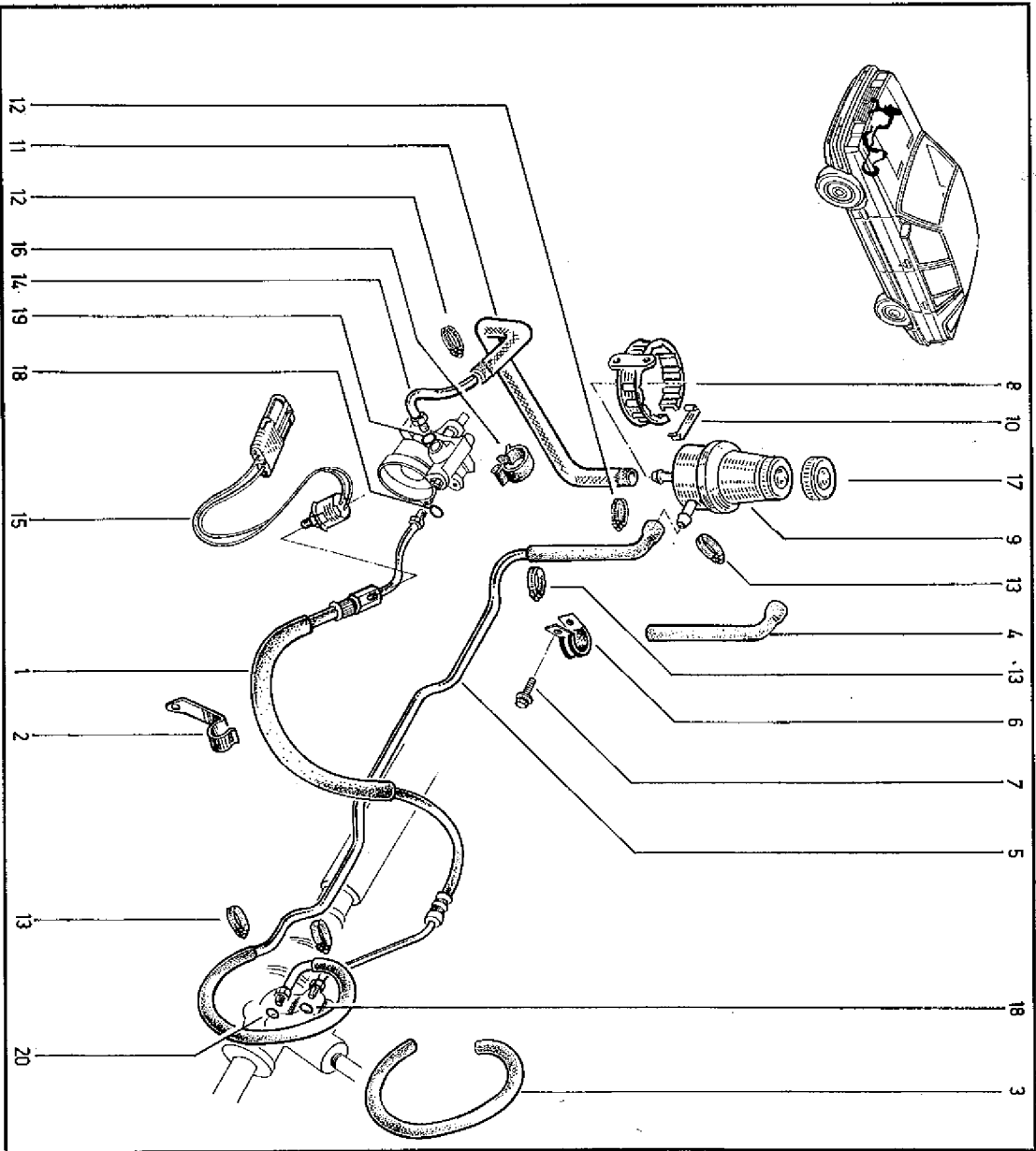

13.81
C.R.1037

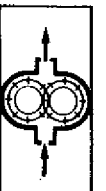

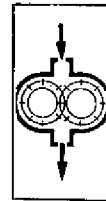

13.85
C.R.1037

- 1 - 77 02 082 544
- 2 - 77 02 089 520
- 3 - 77 02 089 519
- 4 - 77 02 089 518
- 5 - 77 01 588 241
- 6 - 77 05 001 167
- 7 - 77 03 001 947
- 8 - 77 03 055 011
- 9 - 77 03 001 165
- 10 - 77 02 080 637
- 11 - 77 03 101 157
- 12 - 77 03 055 013
- 13 - 77 02 080 640
- 14 - 77 02 080 779
- 15 - 77 02 080 824
- 16 - 77 03 101 046
- 17 - 77 03 055 013
- 18 - 79 03 053 050
- 19 - 77 02 080 639
- 77 02 080 783
- 77 02 080 784
- 18 - 79 03 032 023
- 19 - 77 01 201 897

C

13.85
C.R.1037

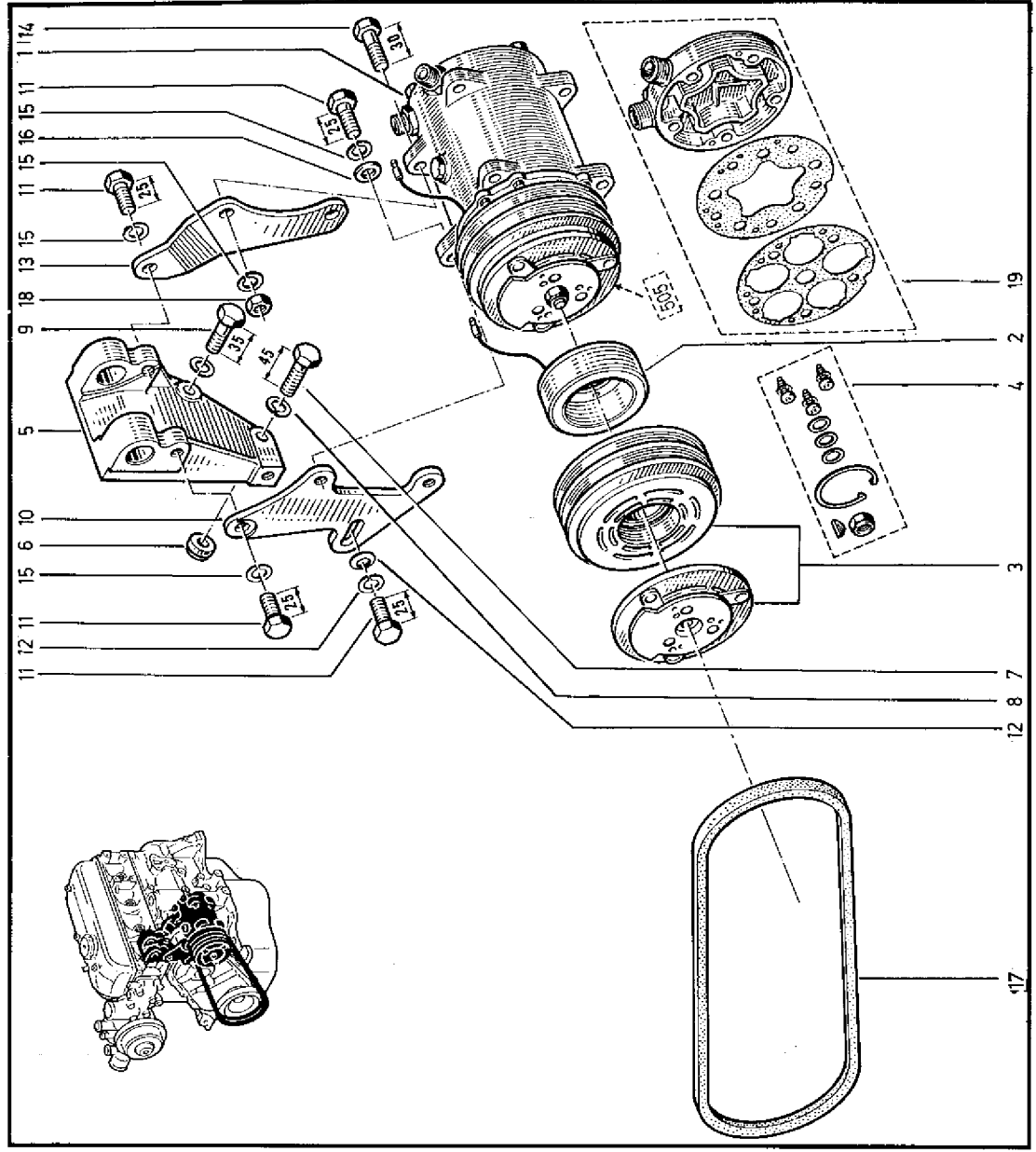
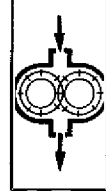



13.90
C.R.1037

- 1 - 60 01 009 233
- 2 - 60 01 004 015 +
- 3 - 60 01 021 237
- 4 - 60 01 004 990
- 5 - 60 03 027 012
- 6 - 77 03 034 120
- 7 - 60 01 004 991
- 8 - 60 01 005 959
- 9 - 77 03 001 955
- 10 - 77 03 055 011
- 11 - 77 03 032 047
- 12 - 77 03 001 158
- 13 - 77 01 202 428

B375

13.90
C.R.1037

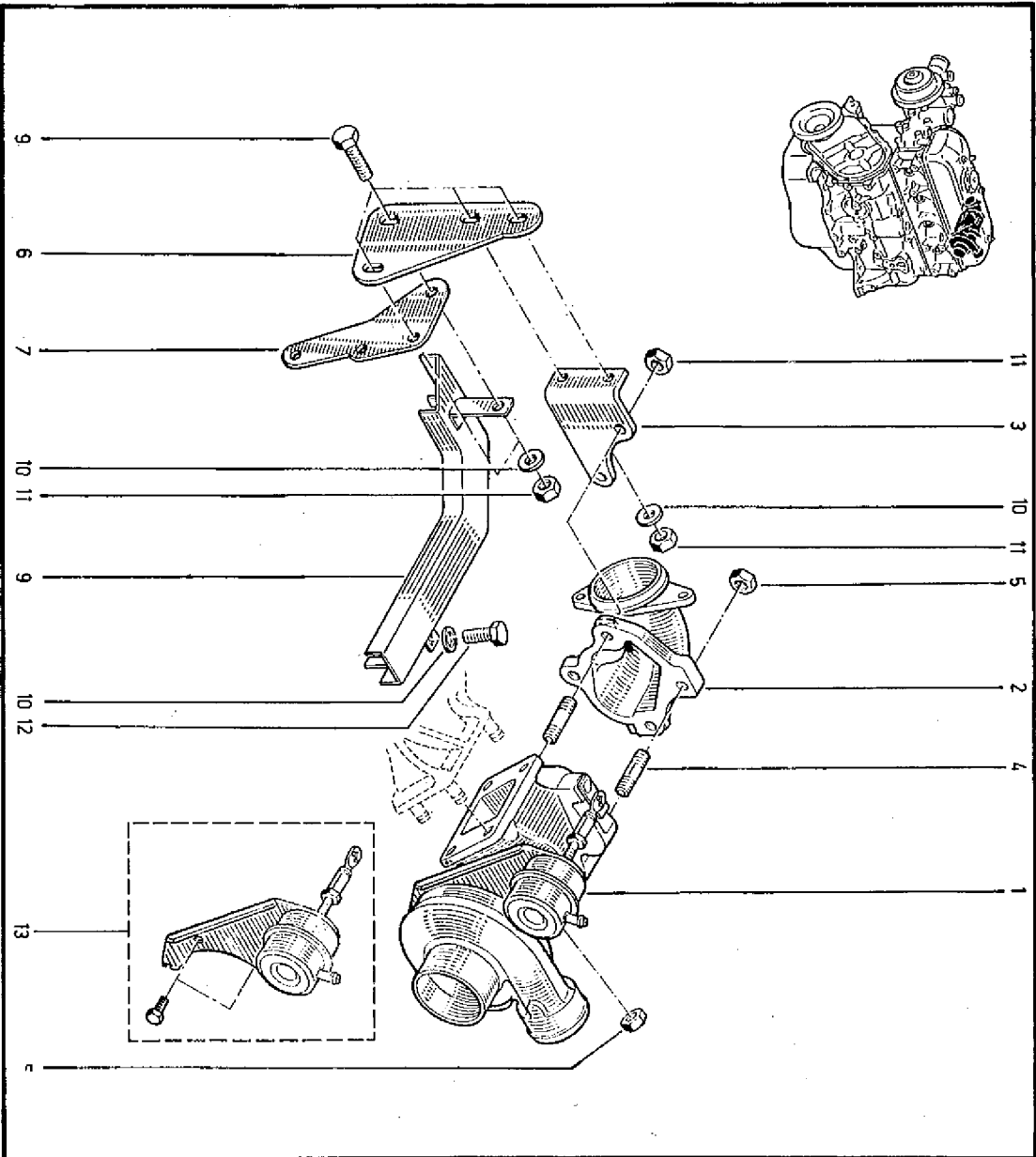

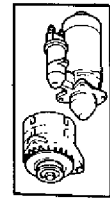

16.01
C.R.1037

- 1 - 77 03 058 034
- 2 - 77 03 101 053
- 3 - 77 00 697 280
- 4 - 77 03 053 037
- 5 - 77 03 055 011
- 6 - 77 03 001 165
- 7 - (1)
- 8 - 77 00 612 542
- 9 - 77 00 512 555
- 10 - 77 03 001 347
- 11 - 79 03 053 043
- 12 - 77 03 001 750
- 13 - 77 03 055 011
- 14 - 79 03 032 018
- 15 - 77 00 708 006 (A)
- 16 - 77 00 708 317 (B)
- 17 - 77 00 612 543
- 18 - 77 05 001 135
- 19 - 77 00 591 156
- 20 - 77 03 001 165
- 21 - 77 00 697 947 +
- 22 - 77 02 080 667
- 23 - 77 02 080 753 (B.375)
- 24 - 77 00 531 906
- 25 - 77 03 001 169
- 26 - 77 03 001 158
- 27 - 79 03 032 016
- 28 - 05 55 485 602
- 29 - 8071557
- 30 - 79 03 056 042
- 31 - 77 02 082 538 (B)
- 32 - 77 02 082 539 (C)
- 33 - 77 02 082 501



16.01
C.R.1037

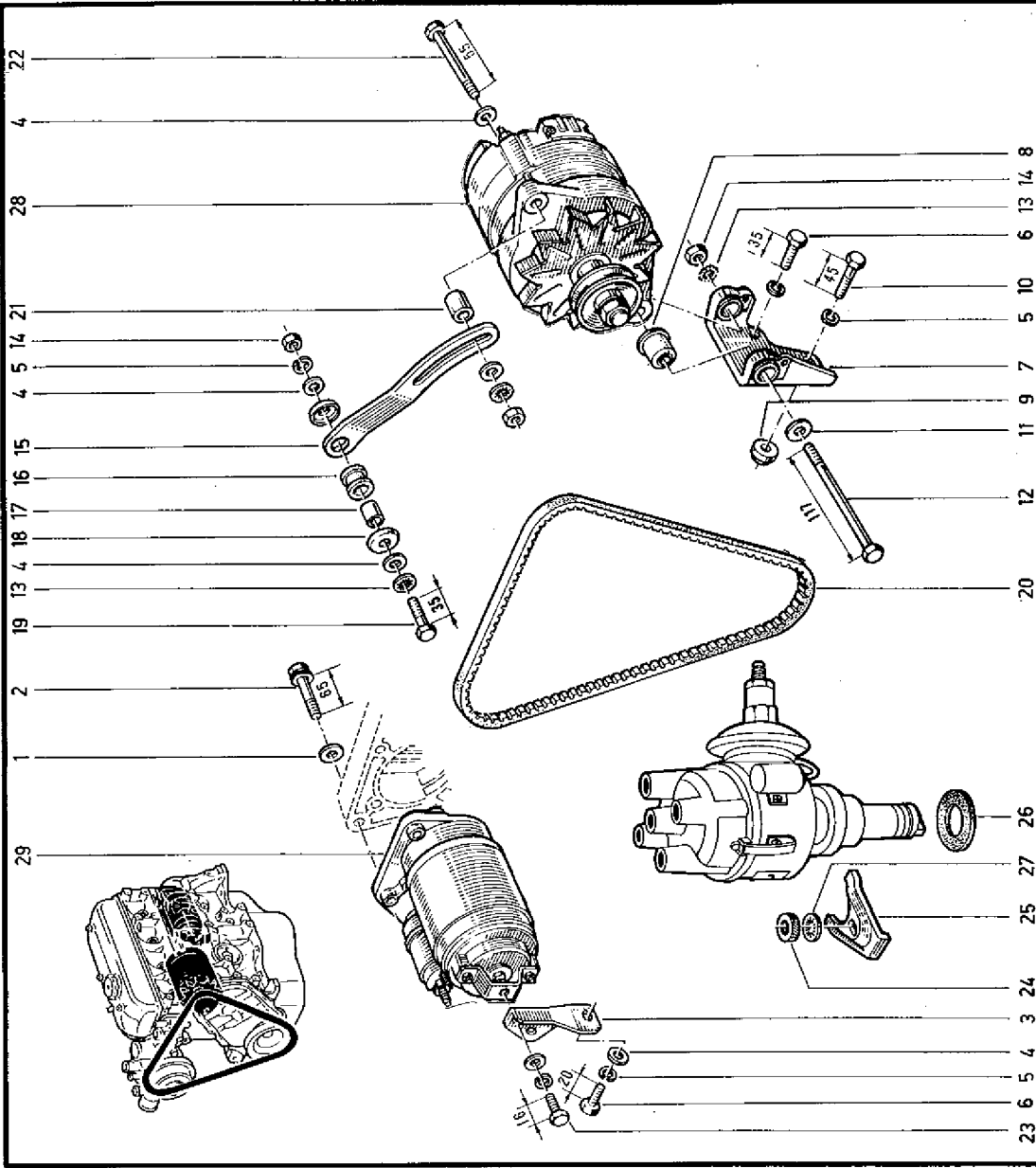

13-80
13-85
K K /

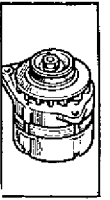

16.05
C.R.1037

- 1 - 77 02 082 534 ☒
- 77 02 082 535 ○
- 2 - 77 02 073 227
- 3 - 2246192
- 4 - 77 02 069 935
- 5 - 2092592
- 6 - 2092576
- 7 - 77 02 069 928
- 8 - 2092575
- 9 - 77 02 069 929
- 10 - 77 02 073 220
- 11 - 77 02 073 803
- 12 - 79 03 053 025
- 13 - 79 03 032 006
- 14 - 77 02 073 206
- 15 - 77 02 073 205
- 16 - 77 03 055 005
- 17 - 77 02 073 212
- 18 - 77 02 073 208
- 19 - 77 02 073 207
- 20 - 80 70 030 109
- 21 - 2246637
- 22 - 77 02 073 216
- 23 - 77 03 055 005
- 24 - 77 02 073 218
- 25 - 77 02 073 805
- 26 - 2016182
- 271 - 77 03 055 005
- 28 - 77 02 069 932
- 29 - 0161874
- 30 - 2093148
- 31 - 77 02 073 804
- 32 - 77 02 073 224
- 33 - 77 02 073 214
- 34 - 77 02 027 870
- 35 - 77 02 073 221
- 36 - 2092582

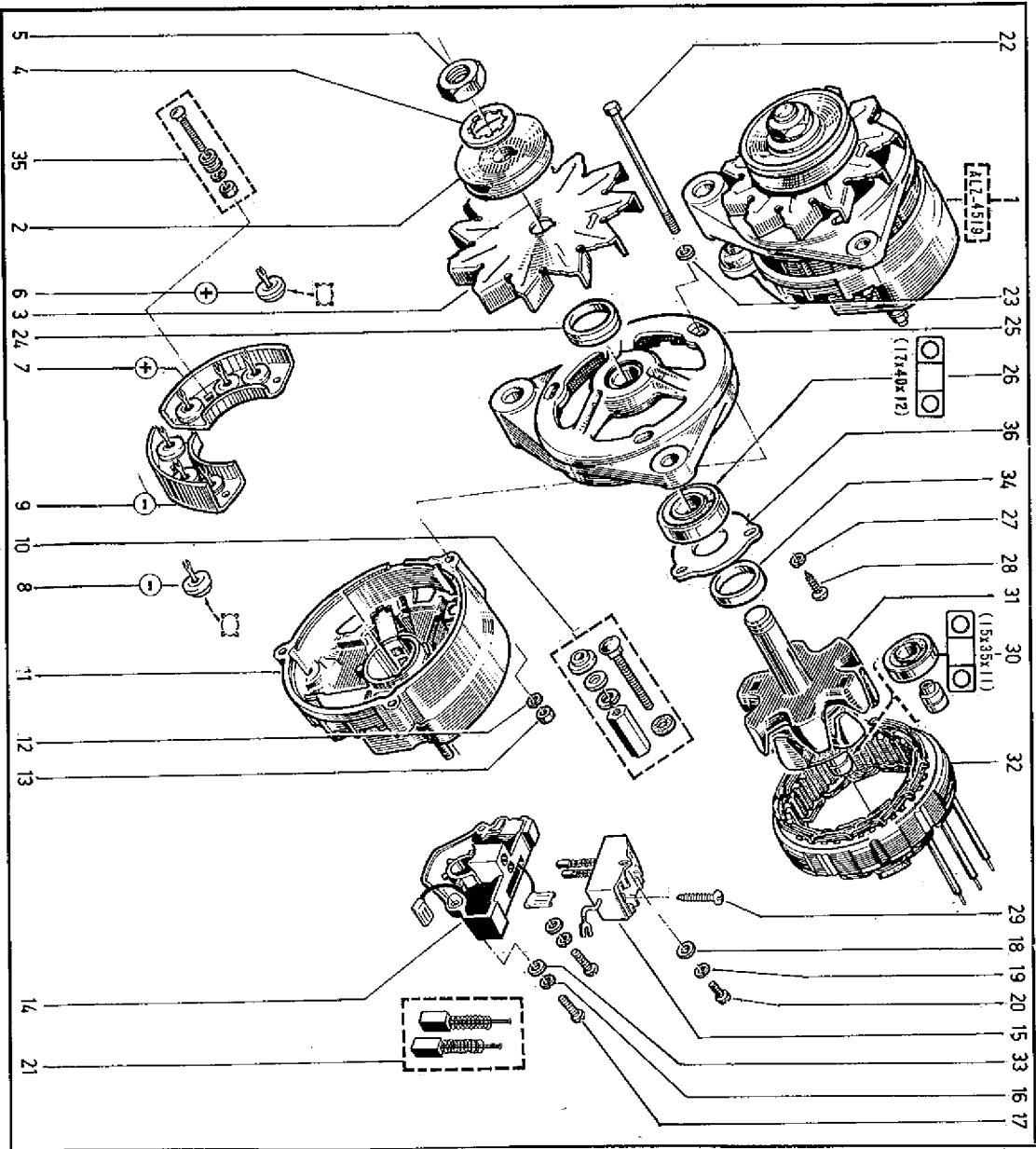

16.05
C.R.1037

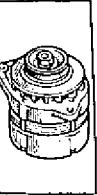



16.15
C.R.1037

- 1 - 77 02 073 877
- 2 - 77 02 073 878
- 3 - 77 02 073 879
- 4 - 77 02 073 984
- 5 - 77 02 073 880
- 6 - 2099364
- 7 - 2097820
- 8 - 2099365
- 9 - 77 02 073 881
- 10 - 2097824
- 11 - 2093148
- 12 - 77 02 073 883
- 13 - 77 02 073 884
- 14 - 77 02 073 892
- 15 - 77 02 073 896
- 16 - 77 02 073 892
- 17 - 2093165
- 18 - 77 02 073 890
- 19 - 77 02 073 896
- 20 - 2003684
- 21 - 2246673
- 22 - 77 02 073 350
- 23 - 77 02 073 876
- 24 - 79 03 053 028
- 25 - 2097831
- 26 - 77 02 073 963
- 27 - 2097829
- 28 - 77 02 073 886
- 29 - 77 02 073 885
- 30 - 77 03 055 007
- 31 - 79 03 032 009
- 32 - 2097838
- 33 - 77 02 073 887
- 34 - 77 02 073 888
- 35 - 77 02 073 999
- 36 - 77 02 073 893 (1)
- 37 - 79 03 056 246 (2)
- 38 - 77 02 073 897
- 39 - 79 03 056 026
- 40 - 77 03 055 007
- 41 - 79 03 032 009

- 42 - 2093165
- 43 - 79 03 032 006
- 44 - 77 02 073 891
- 45 - 77 02 073 894
- 46 - 77 02 082 538
- 47 - 77 02 082 539
- 47 - 77 02 082 538
- 47 - 77 02 206 245 (2)

16.15
C.R.1037

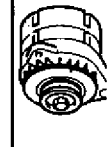

INDIEL

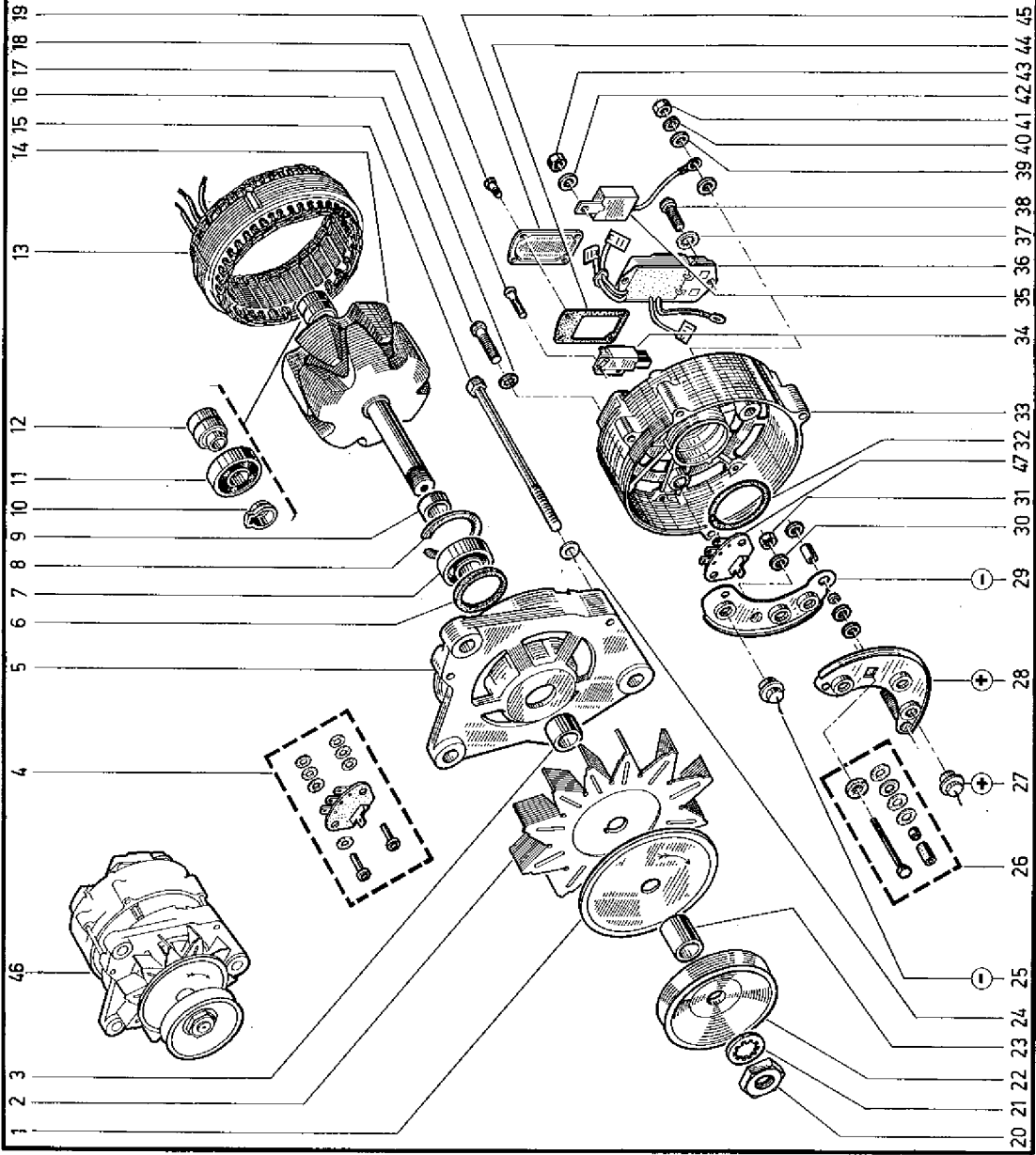

- (1) 77 02 082 538 - 12V - 50A
- 77 02 082 539 - 12V - 70A
- (2) 77 02 082 857 - 12V - 50A
- 77 02 082 858 - 12V - 50A

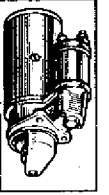

16.70
C.R.1037

- 1 - 77 02 073 963
- 2 - 0948614
- 3 - 77 02 073 953
- 4 - 77 02 073 954
- 5 - 77 02 073 955
- 6 - 77 02 073 956
- 7 - 77 02 073 957
- 8 - 77 02 073 958
- 9 - 77 02 073 959
- 10 - 77 02 073 960
- 11 - 77 02 073 961
- 12 - 77 02 073 962
- 13 - 77 02 073 964
- 14 - 77 02 073 965
- 15 - 77 03 073 966
- 16 - 77 02 073 967 +
77 02 088 735 +
- 17 - 77 02 073 968
- 18 - 1017328
- 19 - 77 02 073 969
- 20 - 77 02 073 970
- 21 - 77 02 073 971
- 22 - 77 02 073 972
- 23 - 77 02 073 973
- 24 - 77 02 073 974
- 25 - 77 02 073 975
- 26 - 77 02 073 976
- 27 - 77 02 073 977
- 28 - 77 02 073 978
- 29 - 77 03 055 005
- 30 - 77 02 073 979
- 31 - 77 02 073 980
- 32 - 77 02 073 981
- 33 - 79 03 053 041
- 34 - 77 03 055 011
- 35 - 79 03 032 018
- 36 - 77 03 055 011
- 37 - 79 03 032 072
- 38 - 77 02 082 501

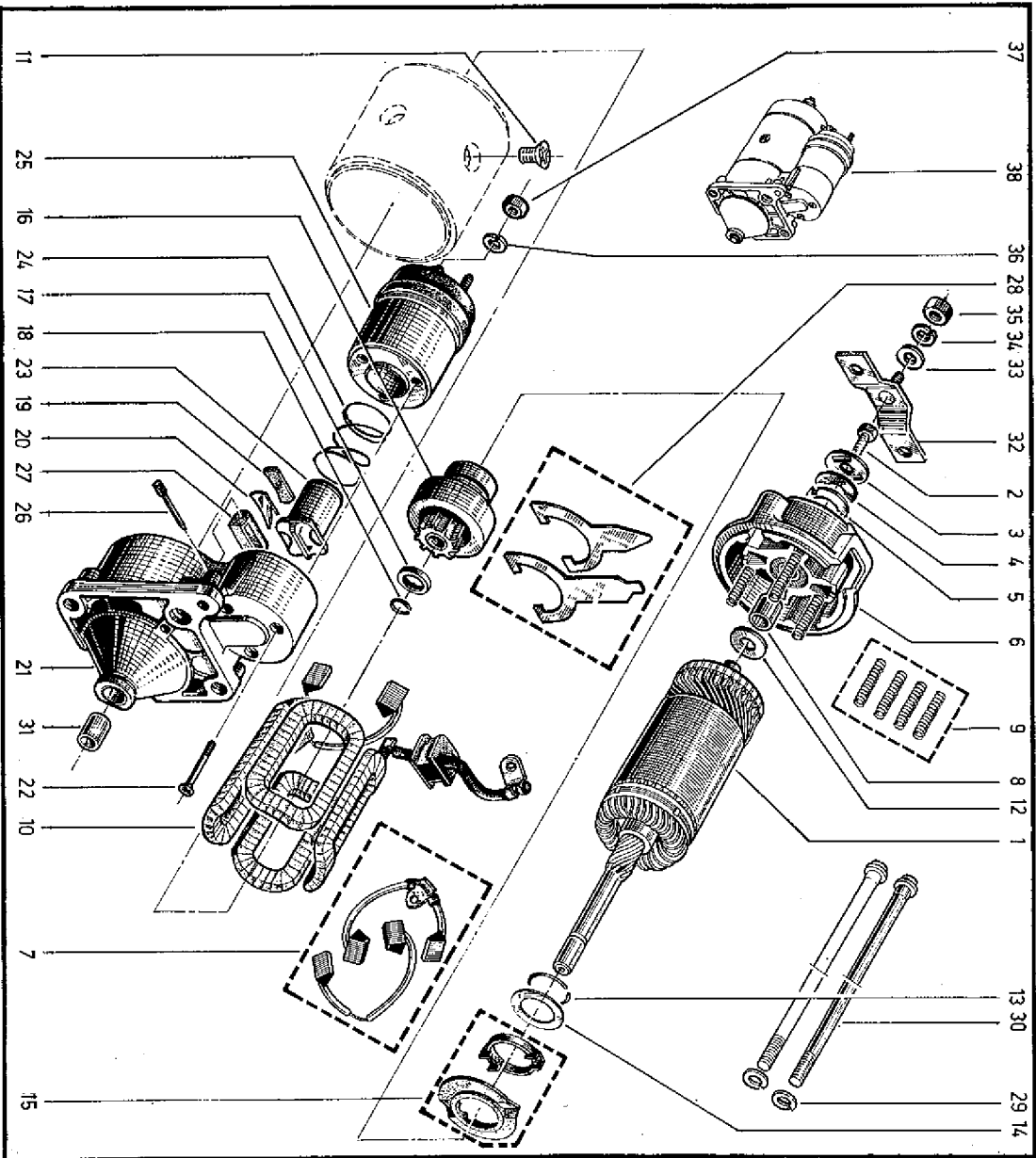

16.70
C.R.1037

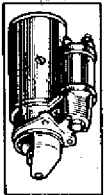

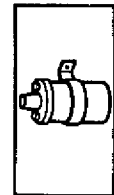

17.05
C.R.1037

- 1 - 2065554
- 2 - 79 03 056 005
- 3 - 79 03 032 006
- 4 - 79 03 032 010
- 5 - 77 02 025 696 †
- 77 00 667 652
- 77 02 082 621 †
- 6 - 77 02 082 555 †
- 77 02 082 618 †
- 77 02 082 756 (1)
- 77 02 082 843 (2)
- 7 - 77 00 638 476
- 8 - 77 03 037 003 †
- 77 03 033 025
- 9 - 77 00 707 368
- 77 02 082 633 (a)
- 10 - 77 03 079 145
- 77 03 079 105



17.05
C.R.1037

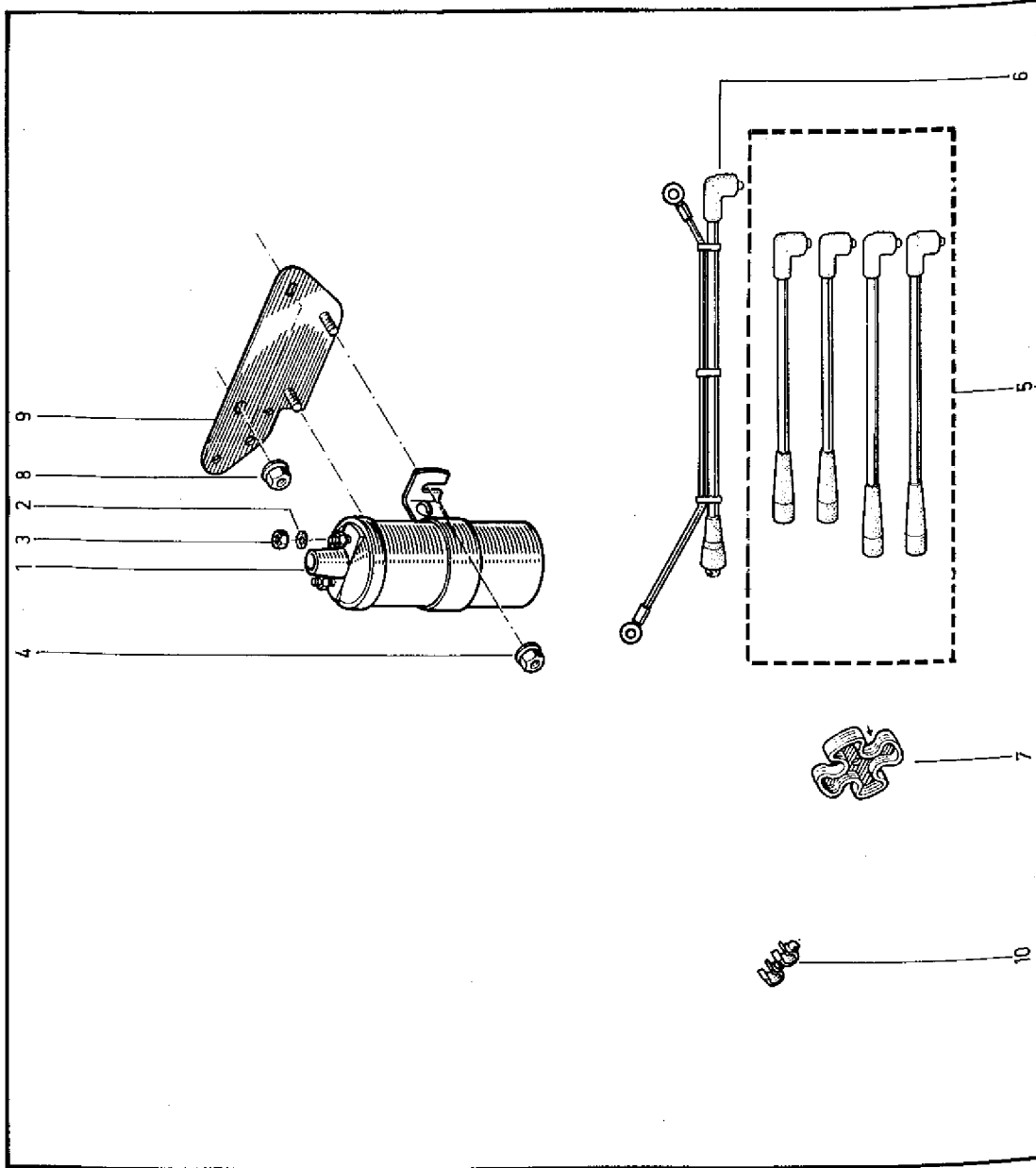

(a) B372 n° 02233 n°
B373 n° 04834 n°

(1) 77 02 086 617 17-10
(2) 77 02 082 843 17-10

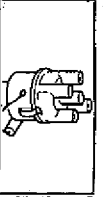

17.10
C.R.1037

- 1 - 77 02 082 615
- 2 - 77 02 073 949
- 3 - 77 02 027 749
- 4 - 0948101
- 5 - 77 02 073 923
- 6 - 77 02 027 748
- 7 - 0948109
- 8 - 0948105
- 9 - 0948127
- 10 - 0948118
- 11 - 77 02 053 106
- 0948088
- 77 02 070 265
- 77 02 088 629 (1)
- 12 - 0948091
- 77 02 070 266
- 77 02 088 630 (1)
- 13 - 0948092
- 14 - 0948098
- 15 - 0948095
- 16 - 0948096
- 17 - 77 02 073 924 +
- 77 02 052 908
- 18 - 0948115
- 19 - 0948123
- 20 - 0948122
- 21 - 0948121
- 22 - 77 02 021 737
- 23 - 10 81 200 449
- 24 - 1017744
- 25 - 77 02 073 925
- 26 - 77 02 021 730
- 27 - 77 02 021 738
- 28 - 77 02 021 731
- 29 - 0948109
- 30 - 77 02 021 729
- 31 - 0948110
- 32 - 77 02 073 950

- 33 - 0948113
- 34 - 0948111
- 35 - 0948094
- 36 - 0948097
- 37 - 77 02 027 755
- 38 - 77 02 082 845
- 77 02 082 872 (a)

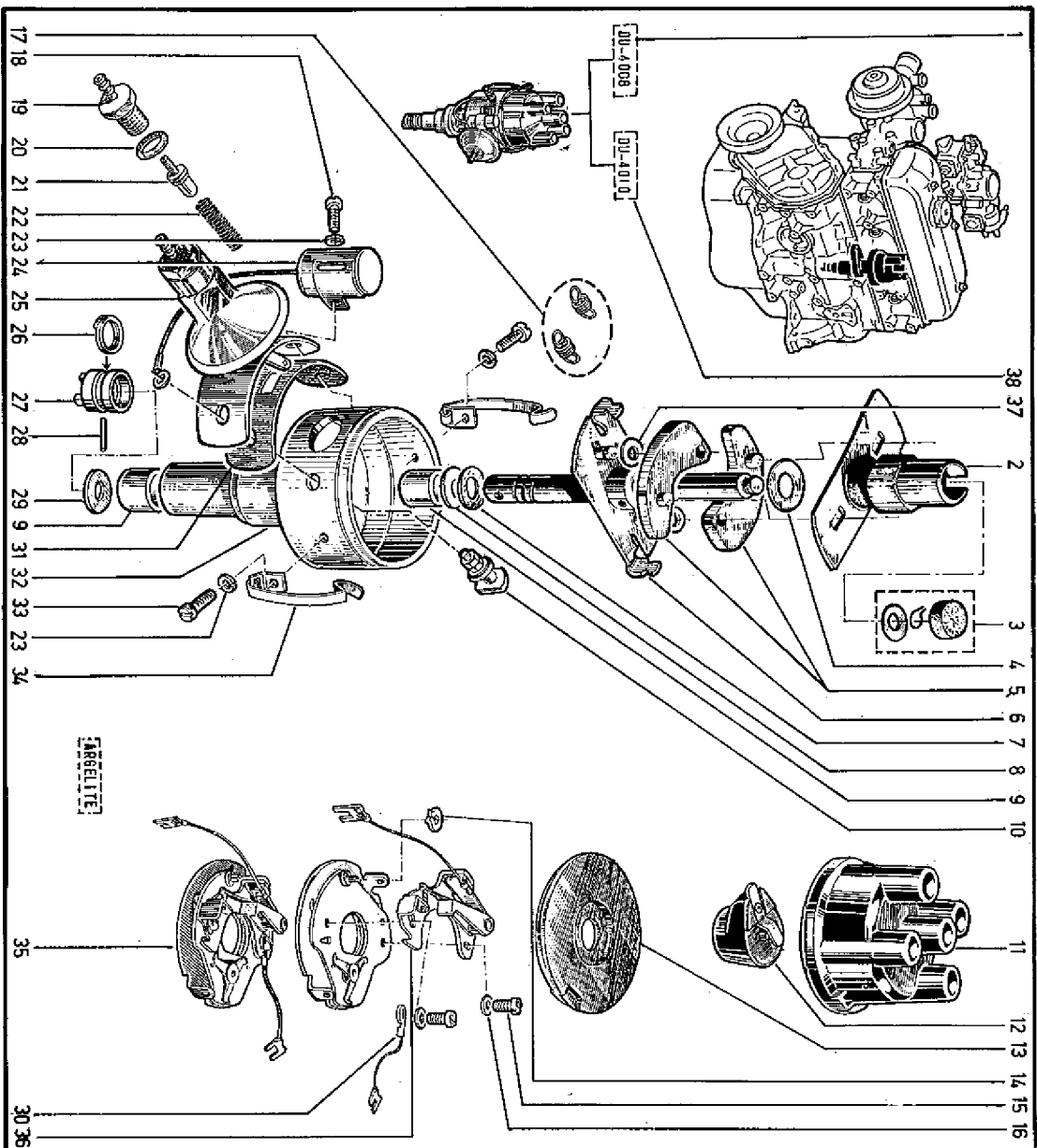

17.10
C.R.1037

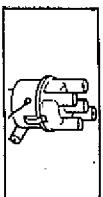

(a) B37T

(1) 77 02 082 617

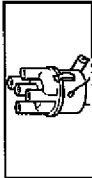

17.11
C.R.1037

- 1 - 77 00 729 838 +
- 2 - 77 00 707 070
- 3 - 6071557
- 4 - 79 03 056 042
- 5 - 77 03 001 142
- 6 - 77 00 577 010
- 7 - 77 02 124 677 (B)
- 8 - 77 01 200 805 (A) +
- 9 - 77 01 027 491 (A) +
- 10 - 77 02 124 325 (B)
- 11 - 77 02 124 318 (B)
- 12 - 77 01 027 870 (A) +
- 13 - 77 02 124 320 (B)
- 14 - 77 01 021 983 (A)
- 15 - 77 02 124 676 (B)
- 16 - 77 01 407 311 (A) (1)
- 17 - 77 01 407 310 (A) (2)

B375

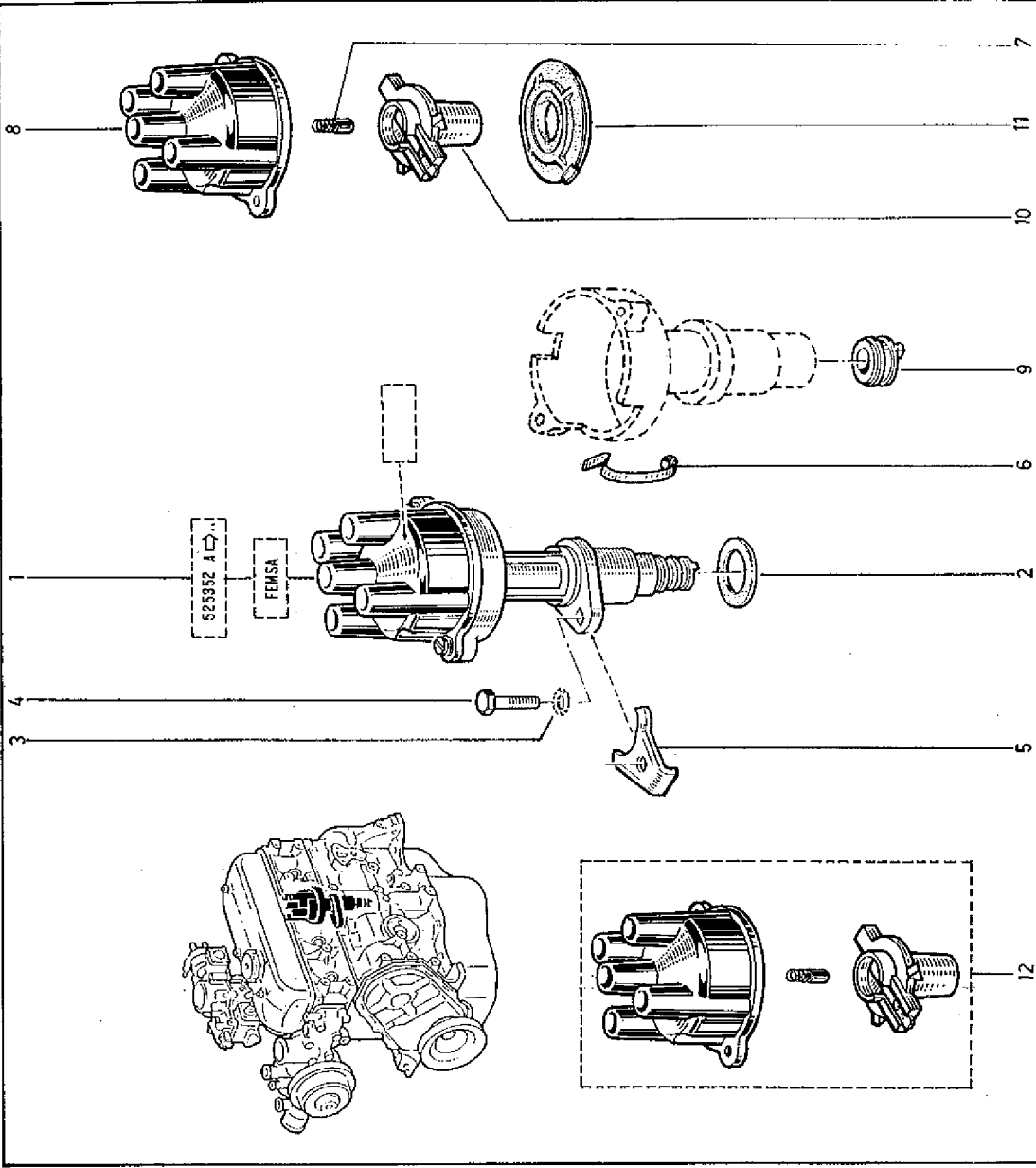

(A) DUCELLIER
(B) FEMSA

(2) 525352 C 525352 D
(1) 525352 A 525352 B

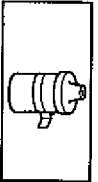

17.12
C.R.1037

- 1 - 77 00 727 032
- 2 - 77 00 728 639
- 3 - 79 03 056 046
- 4 - 77 03 050 116
- 5 - 77 00 667 652
- 6 - 60 01 003 045
- 7 - 77 05 026 248
- 8 - 77 05 030 025
- 9 - 77 00 638 476
- 10 - 77 01 031 135
- 11 - 77 03 019 101
- 12 - 60 01 004 969
- 13 - 77 00 726 011
- 14 - 77 01 026 859
- 15 - 77 03 079 105
- 16 - 77 03 079 043
- 17 - 77 03 079 165

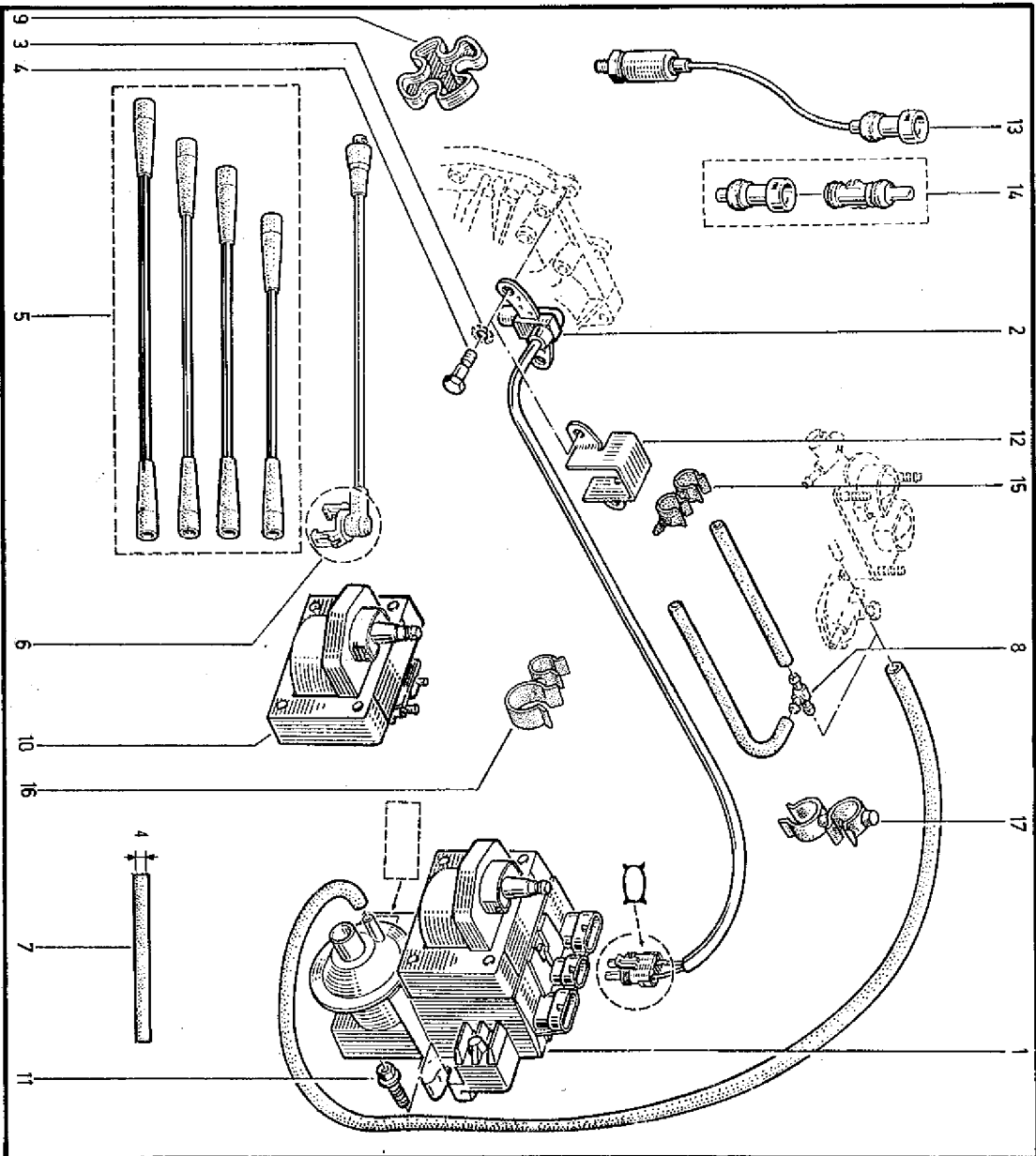

B375

17.12
C.R.1037

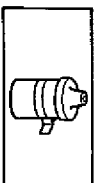

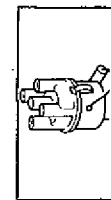

17.15
C.R. 1037

- 1 - 77 02 082 554 †
- 2 - 77 02 070 006
- 3 - 77 02 070 007
- 4 - 77 02 073 776
- 5 - 77 02 070 009
- 6 - 77 02 070 010
- 7 - 77 02 069 970
- 8 - 77 02 069 971
- 9 - 77 02 069 972
- 10 - 77 02 069 973
- 11 - 77 02 069 974
- 12 - 77 02 073 775
- 13 - 77 02 069 976

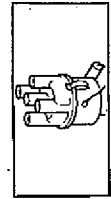

17.15
C.R. 1037

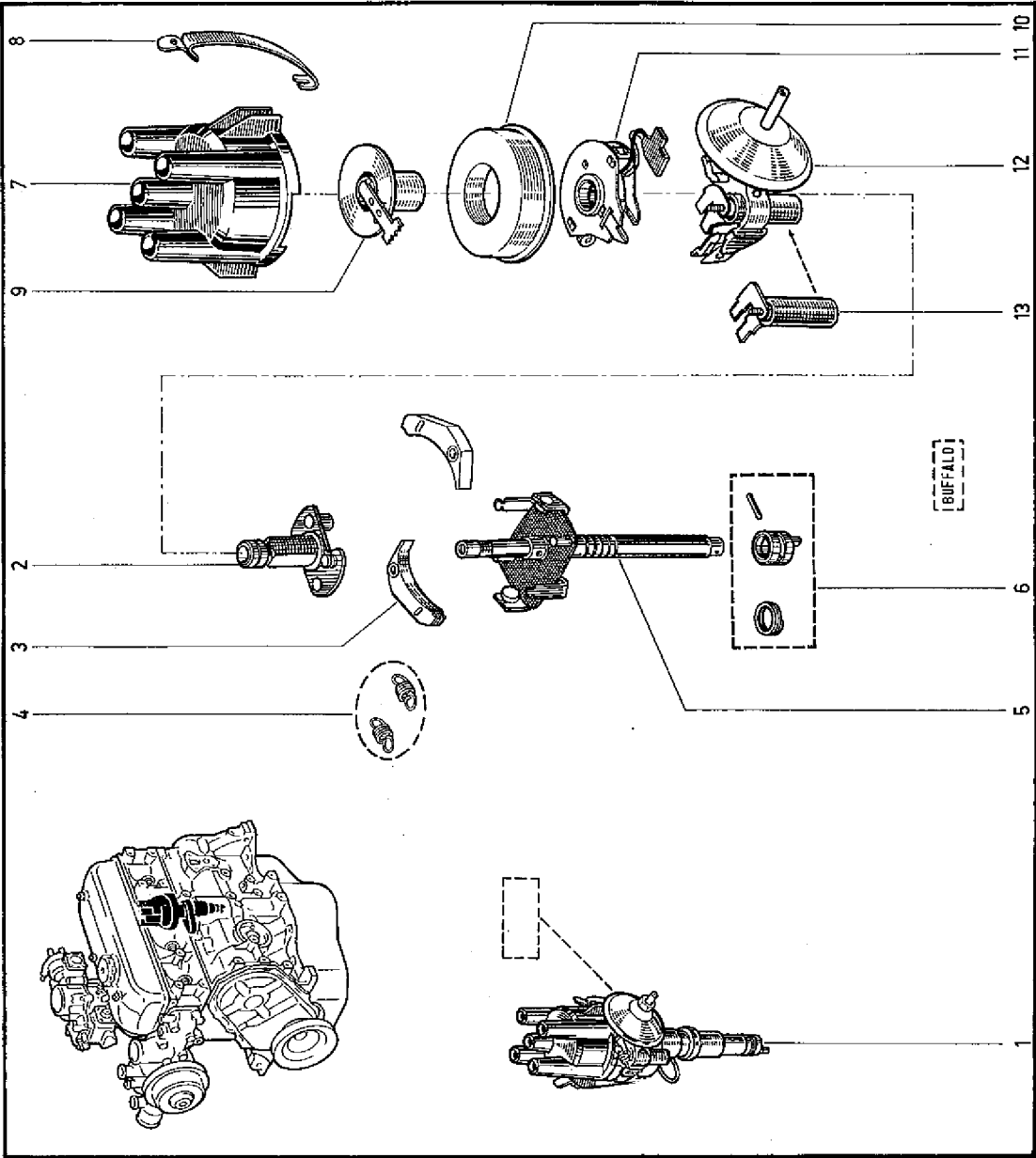



17.20
C.R.1037

- 1 - 77 00 612 290
- 2 - 77 02 088 574
- 3 - 60 01 006 427 (B-375) †
- 4 - 77 02 080 821 (B-375) †
- 5 - 77 02 080 828 (B-375)
- 6 - 77 02 089 487
- 7 - 77 02 089 496

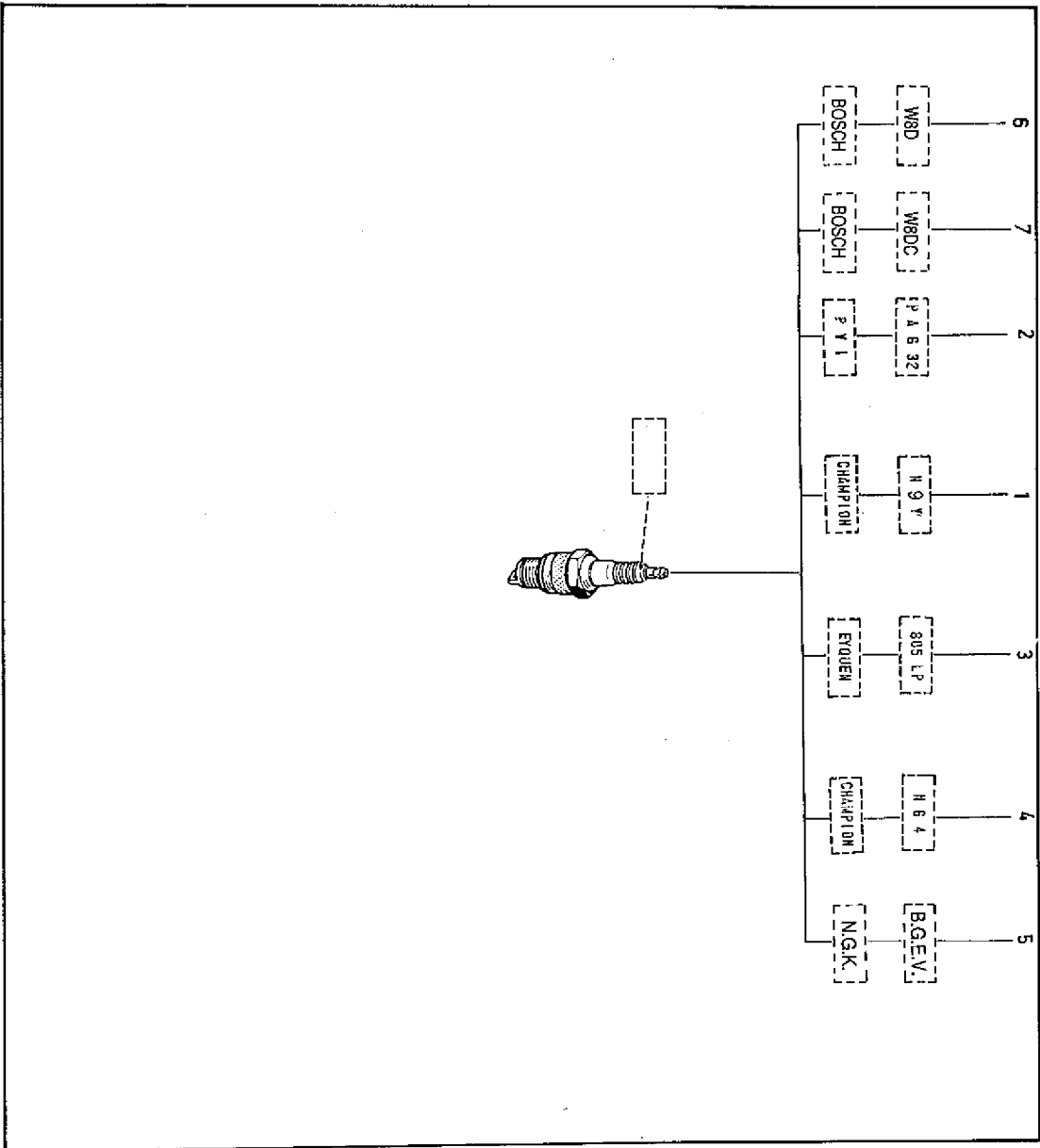

17.20
C.R.1037





19.01
C.R.1037

- 1 - 77 02 080 913 C
- 77 02 080 912 B
- 77 02 085 458 C
- 77 02 085 459 B
- 2 - 77 02 073 835
- 3 - 77 01 073 836 †
- 77 02 073 836
- 4 - 77 00 687 550
- 77 00 683 146
- 5 - 77 00 686 308
- 6 - 77 00 700 370
- 7 - 77 00 686 306
- 8 - 77 00 686 307
- 9 - 77 00 708 710
- 10 - 77 00 751 988
- 77 02 085 336 †
- 77 02 094 325
- 11 - 77 03 077 112
- 12 - 77 02 082 600 C
- 13 - 77 03 019 085
- 14 - 79 03 056 008
- 15 - 79 03 032 010
- 16 - 77 03 001 396
- 17 - 77 03 046 091
- 18 - 77 02 093 513 (B-375)
- 19 - 79 03 053 031 (B-375)
- 20 - 77 03 073 105 (B-375)
- 21 - 77 05 001 032 (B-375)



19.01
C.R.1037

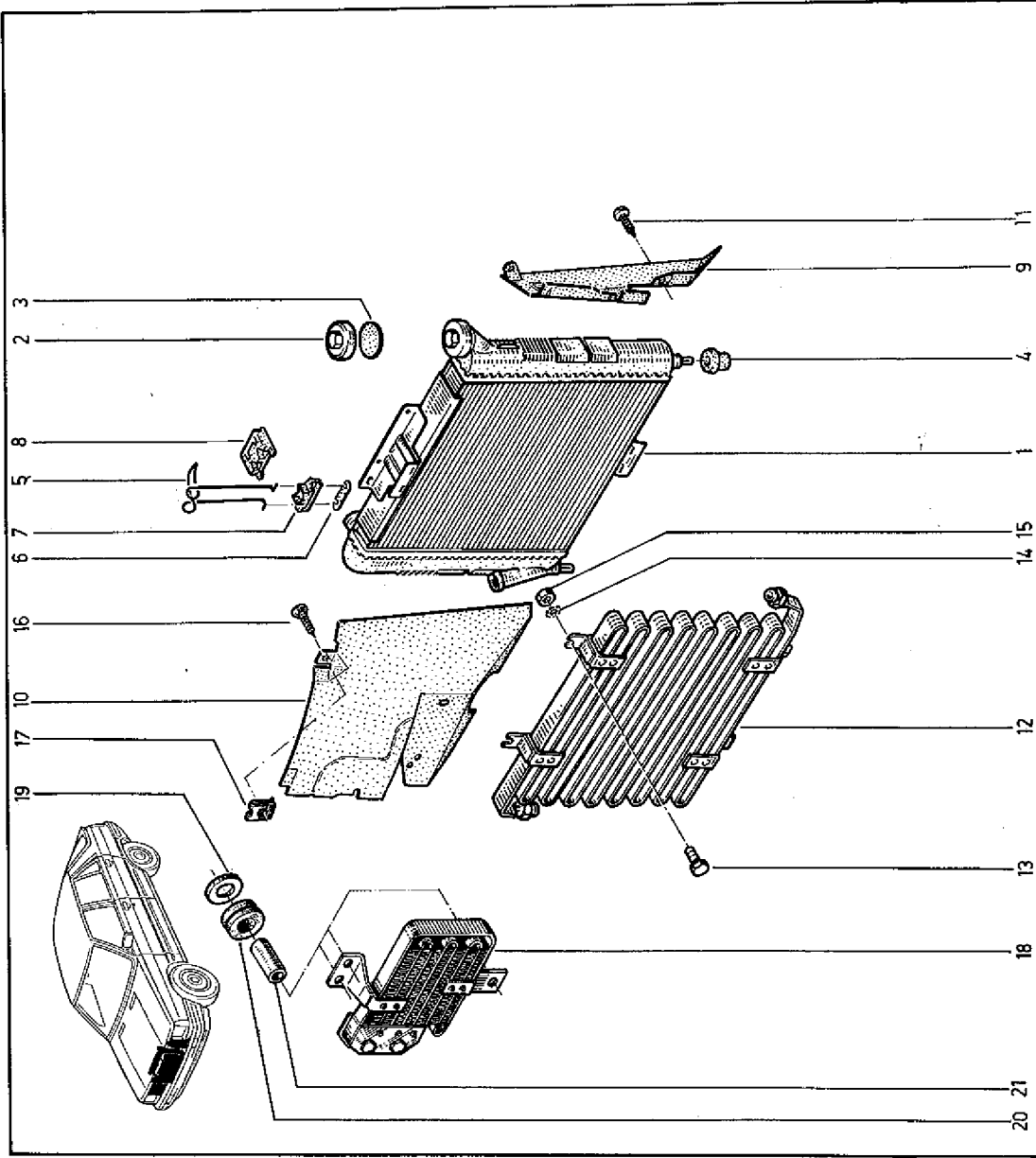

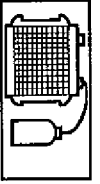

19.04
CR.1037

- 1 - 77 00 762 960
- 2 - 77 04 003 687
- 3 - 77 00 753 206
- 4 - 77 00 754 044
- 5 - 77 00 754 024
- 6 - 77 00 687 550
- 7 - 77 00 754 018
- 8 - 77 03 001 074

B375

19.04
CR.1037

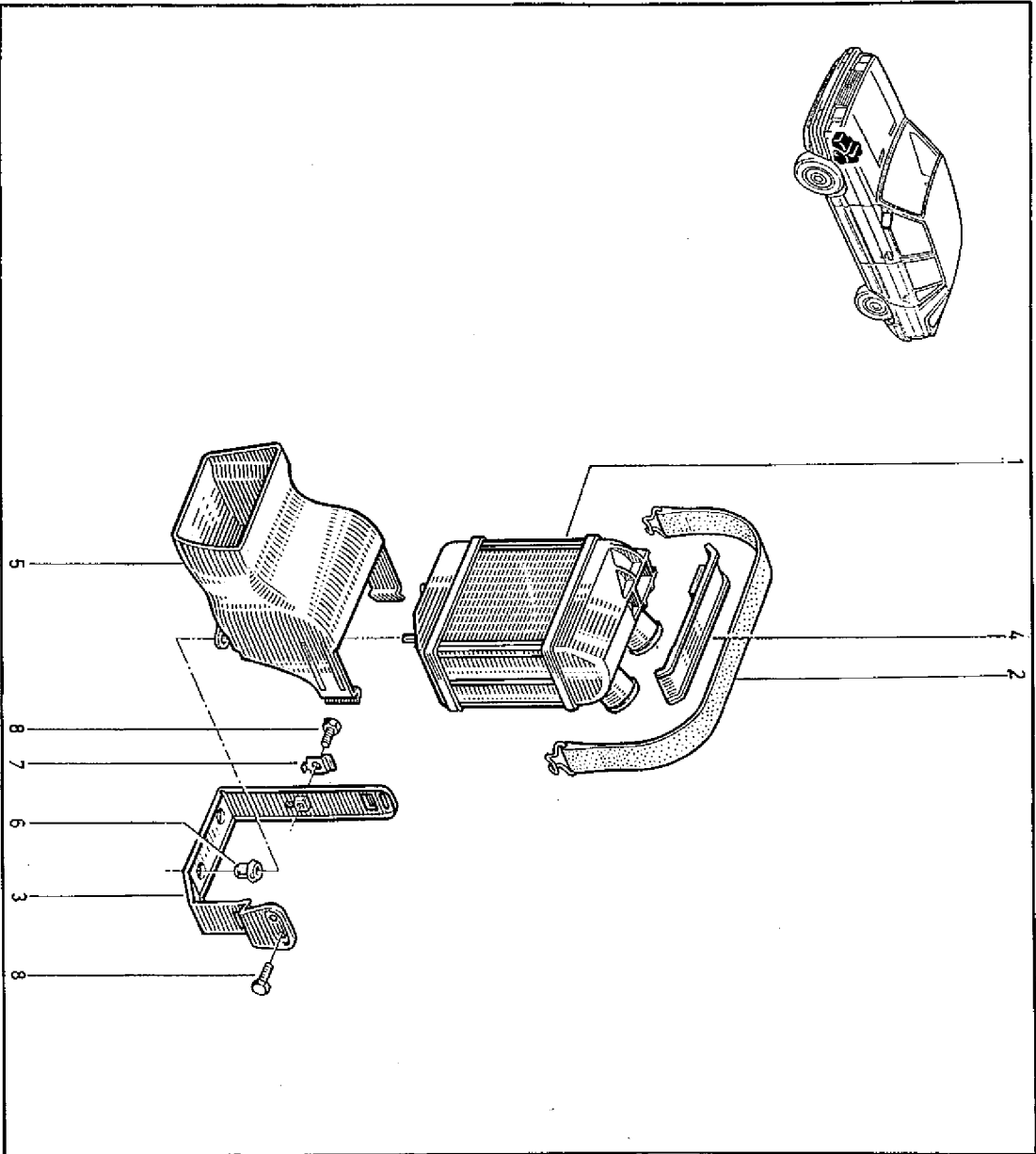
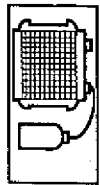

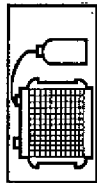

19.10
C.R.1037

- 1 - 77 02 054 601
- 2 - 77 04 001 606
- 3 - 77 01 021 947
- 4 - 77 03 078 111
- 5 - 77 00 589 318
- 6 - 77 04 000 715 (B-375)
- 7 - 77 00 758 977 (B-375)
- 8 - 77 02 082 529



19.10
C.R.1037

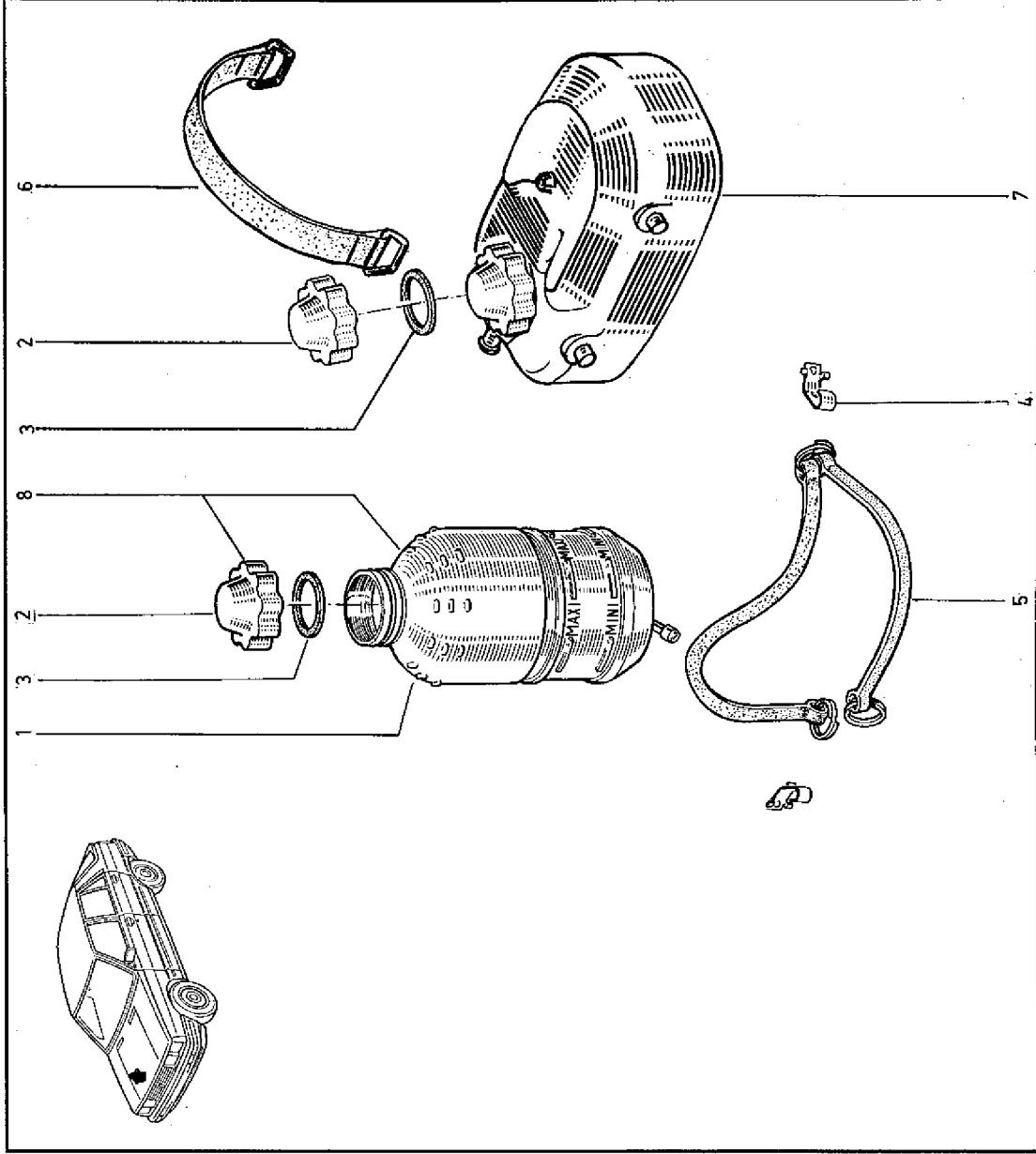



19.20
C.R.T037

- 1 - 77 02 081 027
- 2 - 77 00 518 589
- 3 - 77 03 061 007
- 4 - 77 02 081 050
- 5 - 77 02 081 026
- 6 - 09 90 103 400
- 7 - 77 03 079 072
- 8 - 77 03 078 060
- 9 - 77 02 056 691
- 10 - 77 03 079 103 +
- 11 - 77 02 085 445 (B375) +
- 12 - 77 02 085 403 (B375)
- 13 - 77 02 085 442 (B375)
- 14 - 77 02 085 443 (B375)

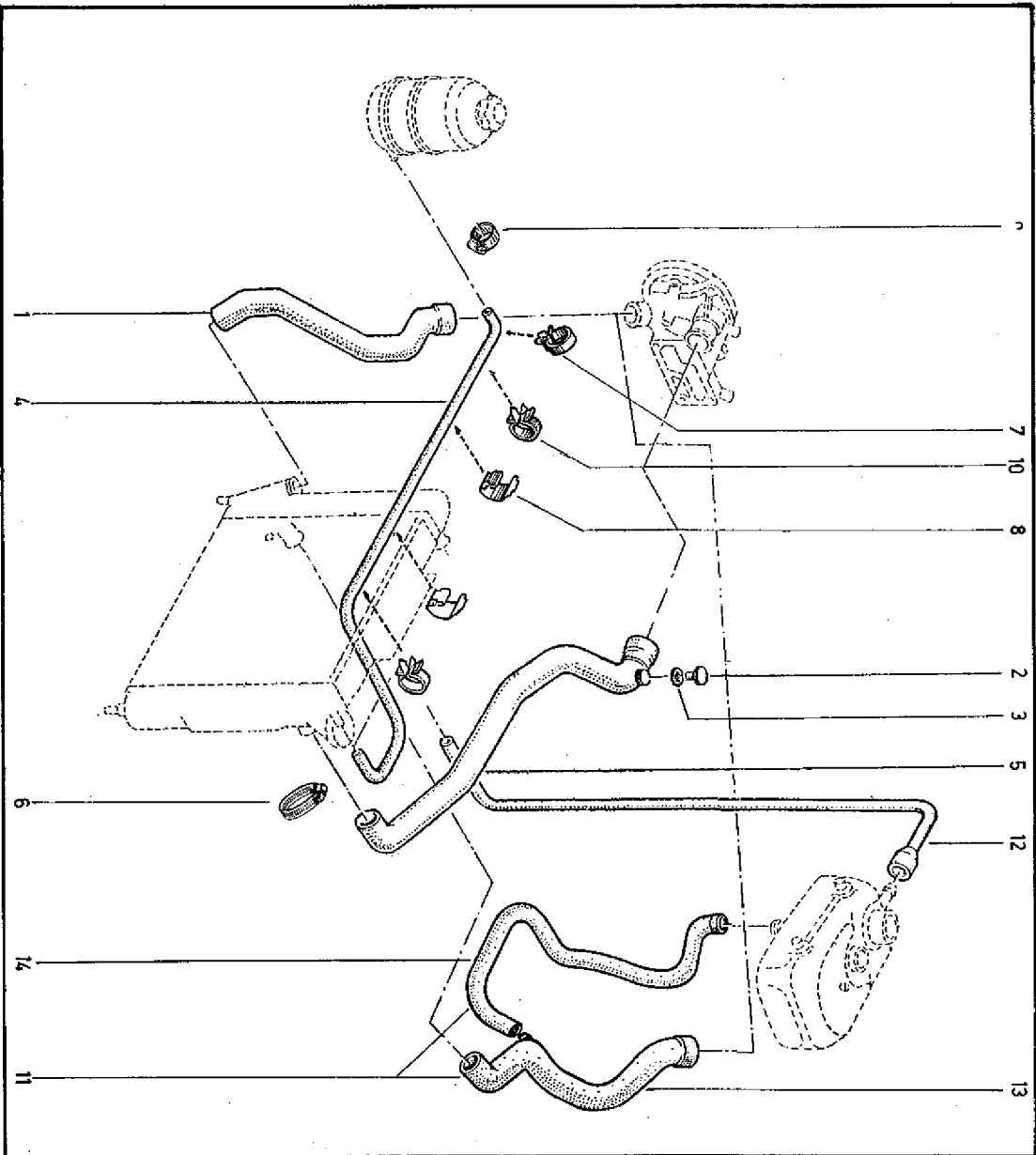

19.20
C.R.T037



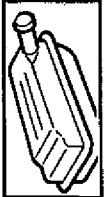

19.30
C.R.1037

- 1 - 77 02 081 048
- 2 - 77 03 019 107
- 3 - 77 03 190 082
- 4 - 79 03 053 048
- 5 - 77 03 044 094
- 6 - 77 00 576 366
- 7 - 77 00 698 544 +
- 8 - 77 00 532 135
- 9 - 77 00 699 619
- 10 - 77 00 685 998
- 11 - 77 03 019 087
- 12 - 77 00 699 568
- 13 - 77 05 026 182
- 14 - 77 00 687 327
- 15 - 77 02 080 928
- 16 - 77 02 080 929
- 17 - 09 90 009 600
- 18 - 77 02 081 045
- 19 - 77 02 088 649
- 77 02 088 852



19.30
C.R.1037

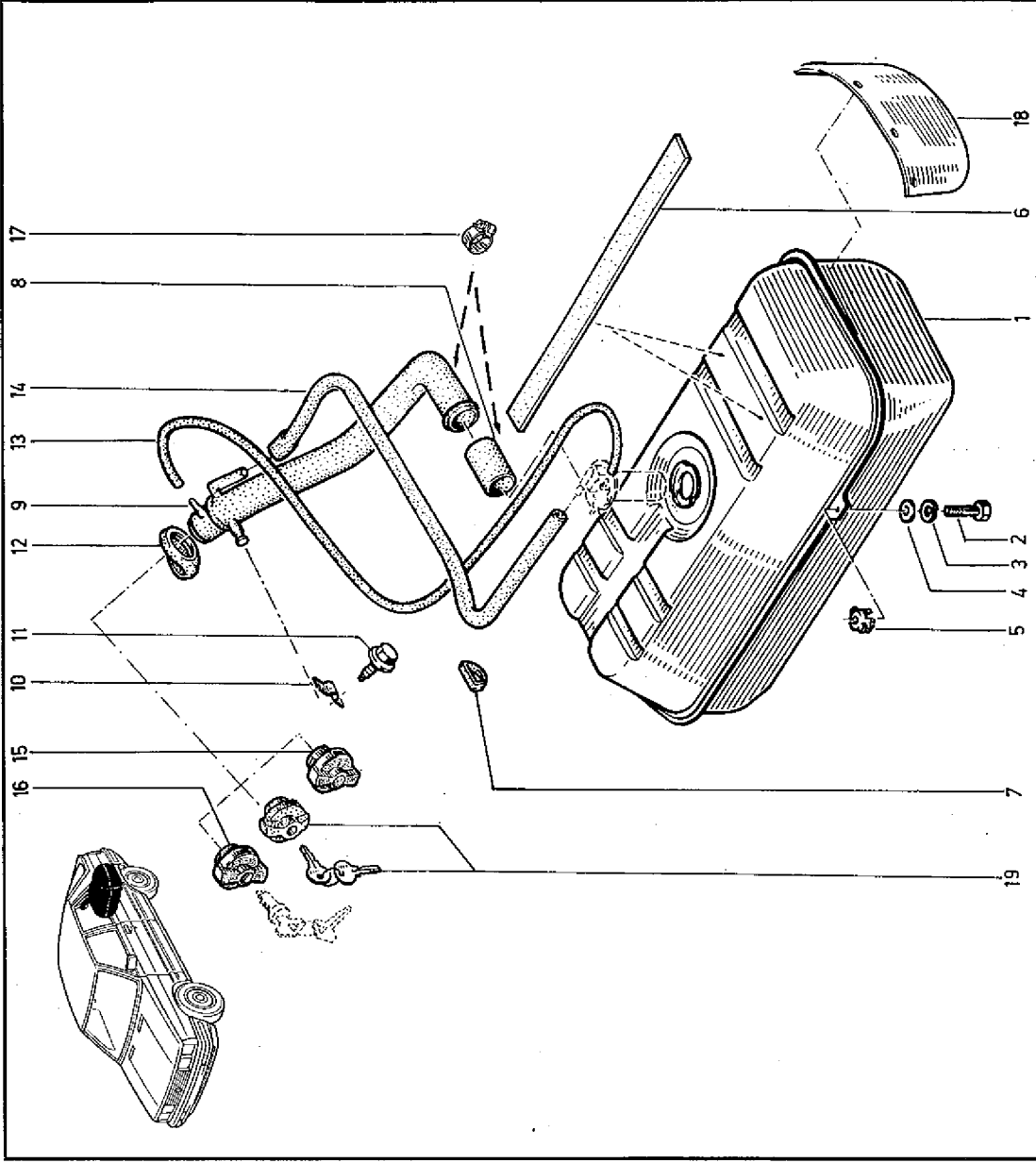

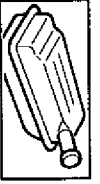



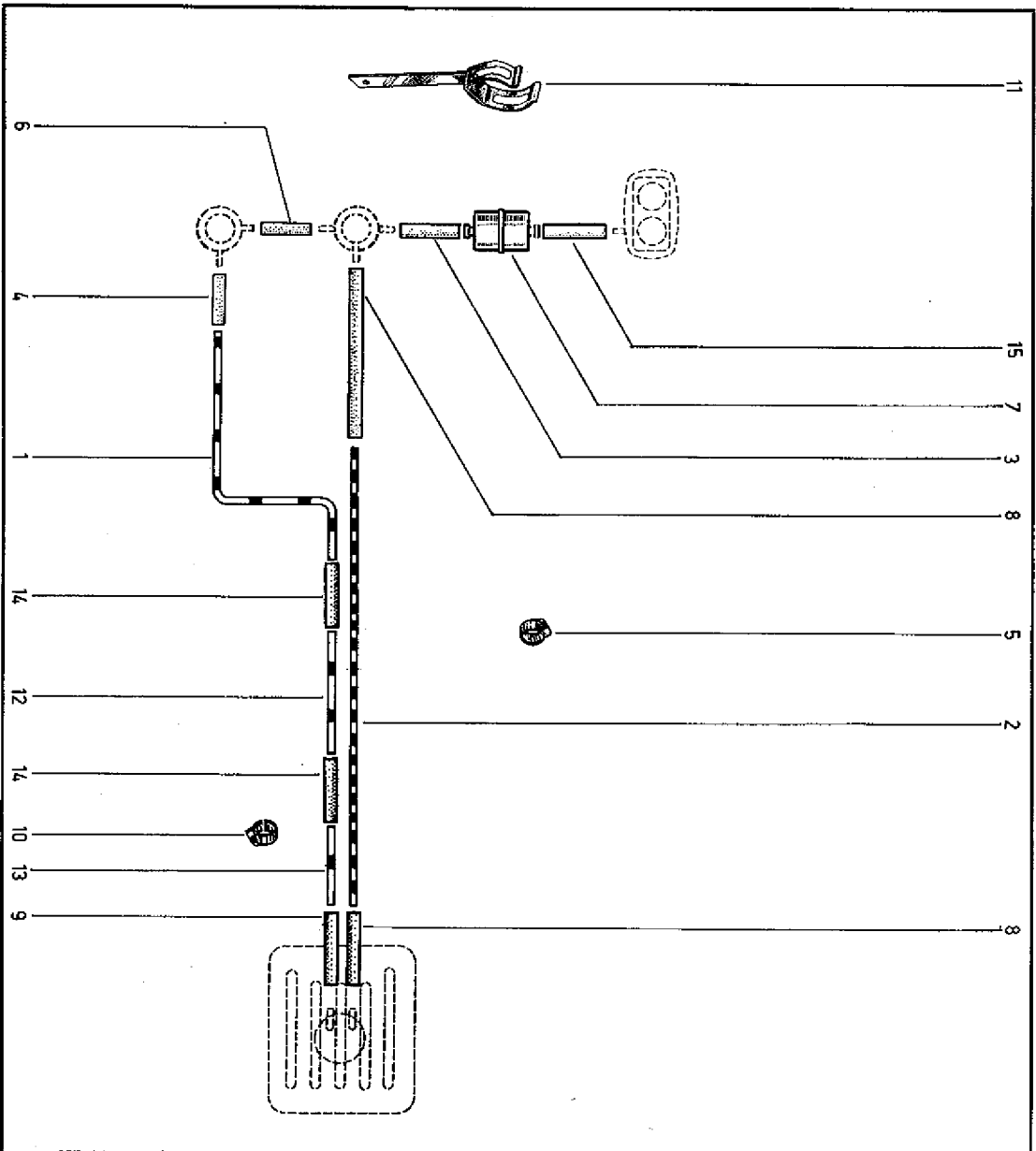

19 40
C.R.1037

- 1 - 77 02 085 190
- 2 - 77 00 689 706
- 3 - 77 02 080 693
- 4 - 77 02 085 207
- 5 - 77 02 083 149
- 6 - 77 02 085 207 ($\varnothing < 1m$)
- 7 - 77 02 073 147
- 8 - 77 02 085 058 ($\varnothing < 1m$)
- 9 - 77 02 085 057 ($\varnothing < 1m$)
- 10 - 77 02 081 036
- 11 - 77 02 080 689
- 12 - 77 02 085 191
- 13 - 77 02 085 192
- 14 - 77 02 054 803
- 15 - 77 02 086 421

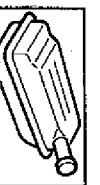

19 40
C.R.1037



B372  n° 02233  n°
 B373  n° 04834  n°



19.41
C.R.1037

- 1 - 77 05 026 105
- 2 - 77 05 026 589
- 3 - 77 05 026 590
- 4 - 77 05 026 225
- 5 - 77 05 026 571
- 6 - 77 05 026 587
- 7 - 77 02 080 735
- 8 - 77 02 085 389
- 9 - 77 00 689 704

B375

19.41
C.R.1037

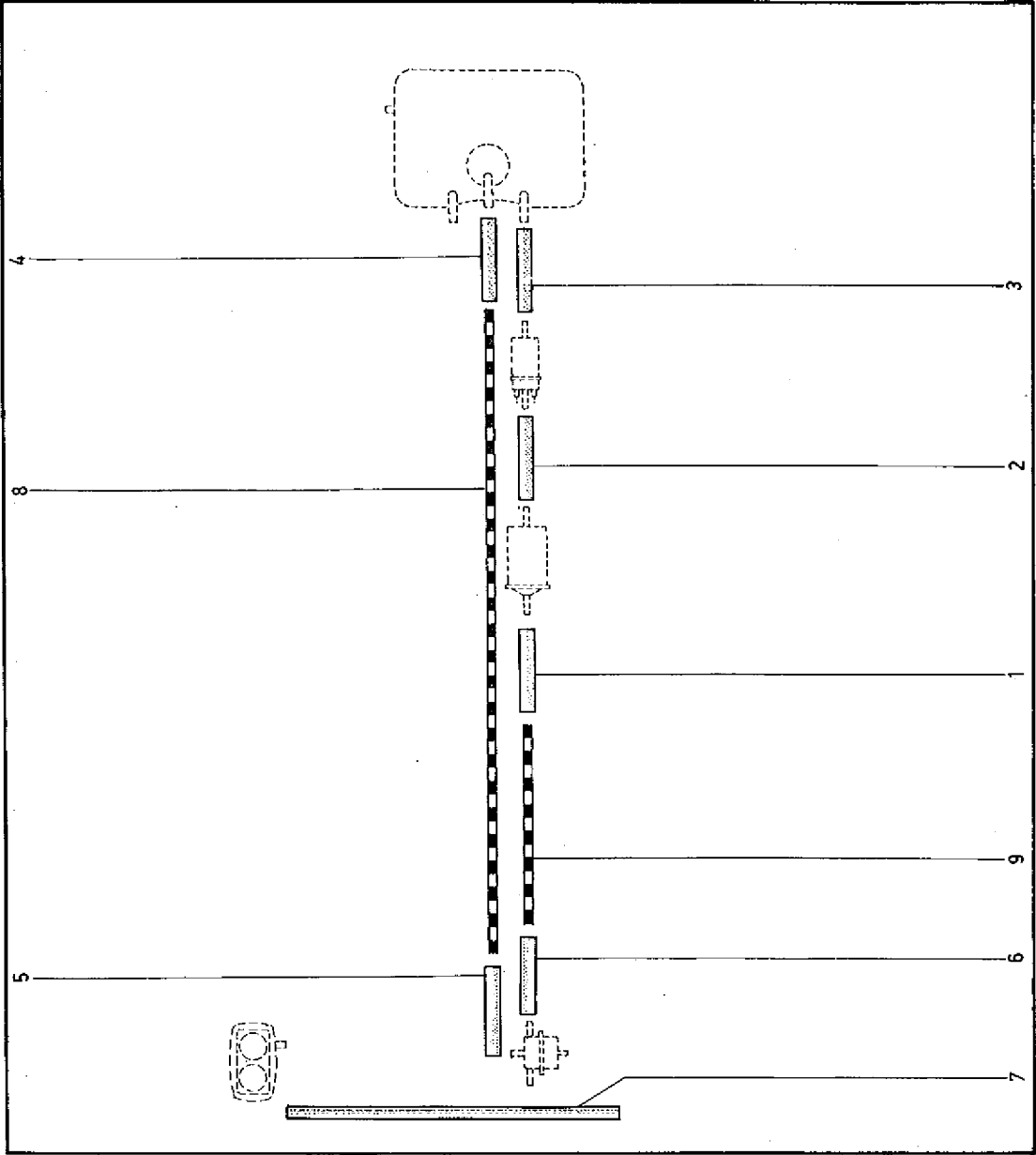

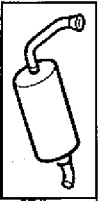

19.50
C.R.1037

- 1 - 77 03 027 168
- 2 - 77 00 682 219 (a) (b)
77 02 081 058 (a)
- 3 - 77 00 683 660
- 4 - 77 00 701 831
- 5 - 77 03 053 037
- 6 - 77 03 035 003
- 7 - 77 03 083 029 (x = 49)
- 8 - 77 00 752 236 (a) +
77 02 081 059 (a) +
- 9 - 77 00 752 234 (b)
77 02 081 061 (d)
- 10 - 77 00 686 449
- 11 - 77 03 058 045 (c)
- 12 - 77 03 034 046 (c)
- 13 - 77 00 766 486 (c)
- 14 - 77 03 101 215 (c) +
77 02 093 567 (c)
- 15 - 77 00 758 970 (c)
- 16 - 77 00 753 030 (c)
- 17 - 77 03 002 050 (c)
- 18 - 77 00 766 486 (c)
- 19 - 77 03 001 160 (c)
- 20 - 77 00 765 122 (c)
77 00 752 204 (c)
- 21 - 77 00 752 707 (c)
- 22 - 77 03 044 087 (c)
- 23 - 77 03 019 087 (c)
- 24 - 77 00 677 733 (c)
- 25 - 77 00 766 881 (c) +
60 01 009 580 (c)
- 26 - 77 00 762 050 (c)

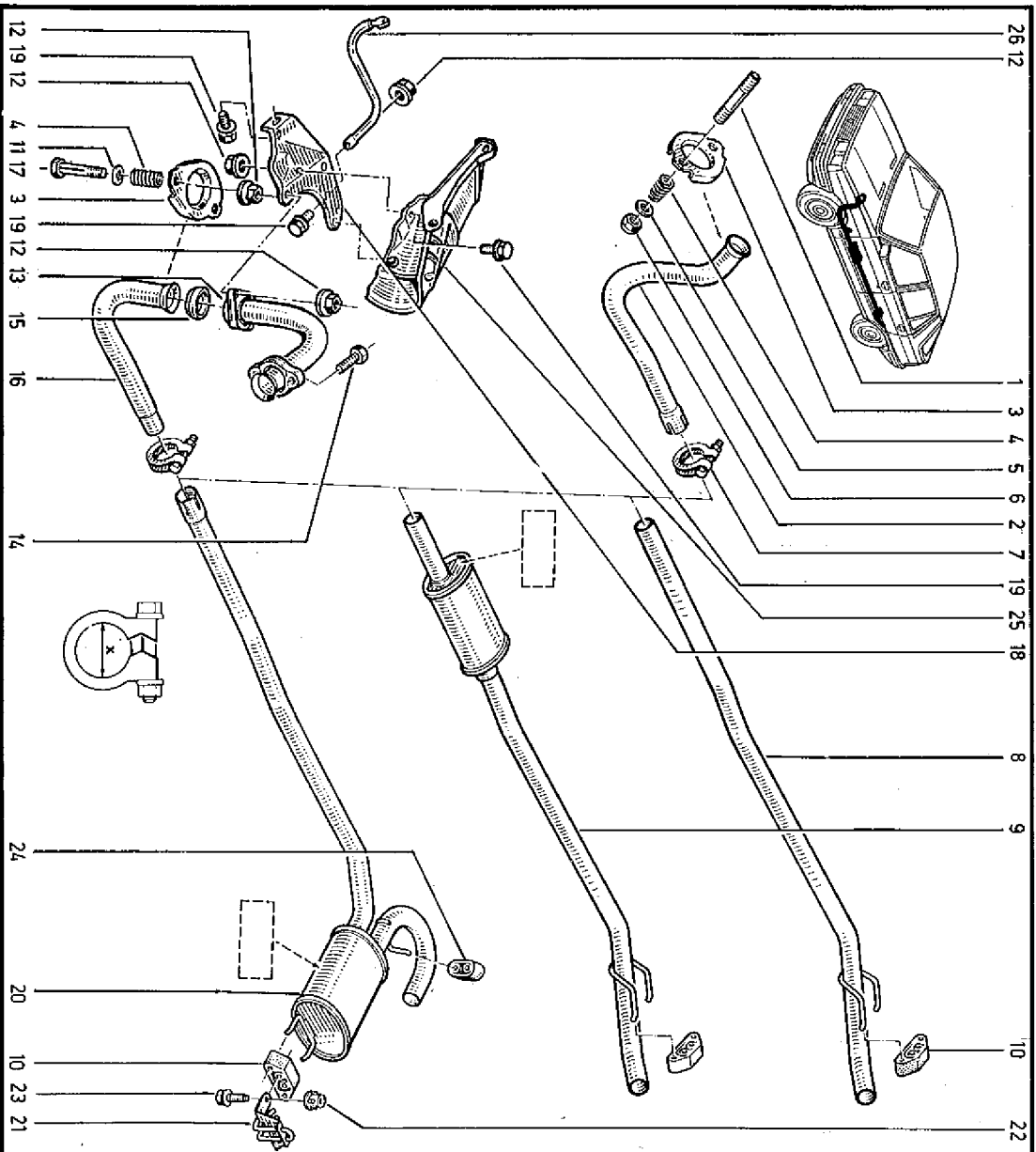

19.50
C.R.1037

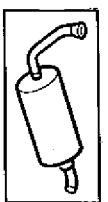

12 19 12 4 11 17 3 19 12 13 15 16 14 24 20 10 23 21

(a) / B-372 n° 1 n° 03510

(b) / B-373 n° 1 n° 07068

(c) / B-375

(d) / B-372 n° 03511 n°

B-373 n° 07069 n°

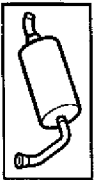

19.60
C.R.1037

- 1 - 77 02 081 007
- 77 00 753 455 (B-375)
- 77 00 765 124 (B-375)
- 2 - 77 03 083 029 (x = 40)
- 3 - 77 00 677 733
- 4 - 77 00 686 449

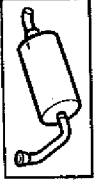

19.60
C.R.1037

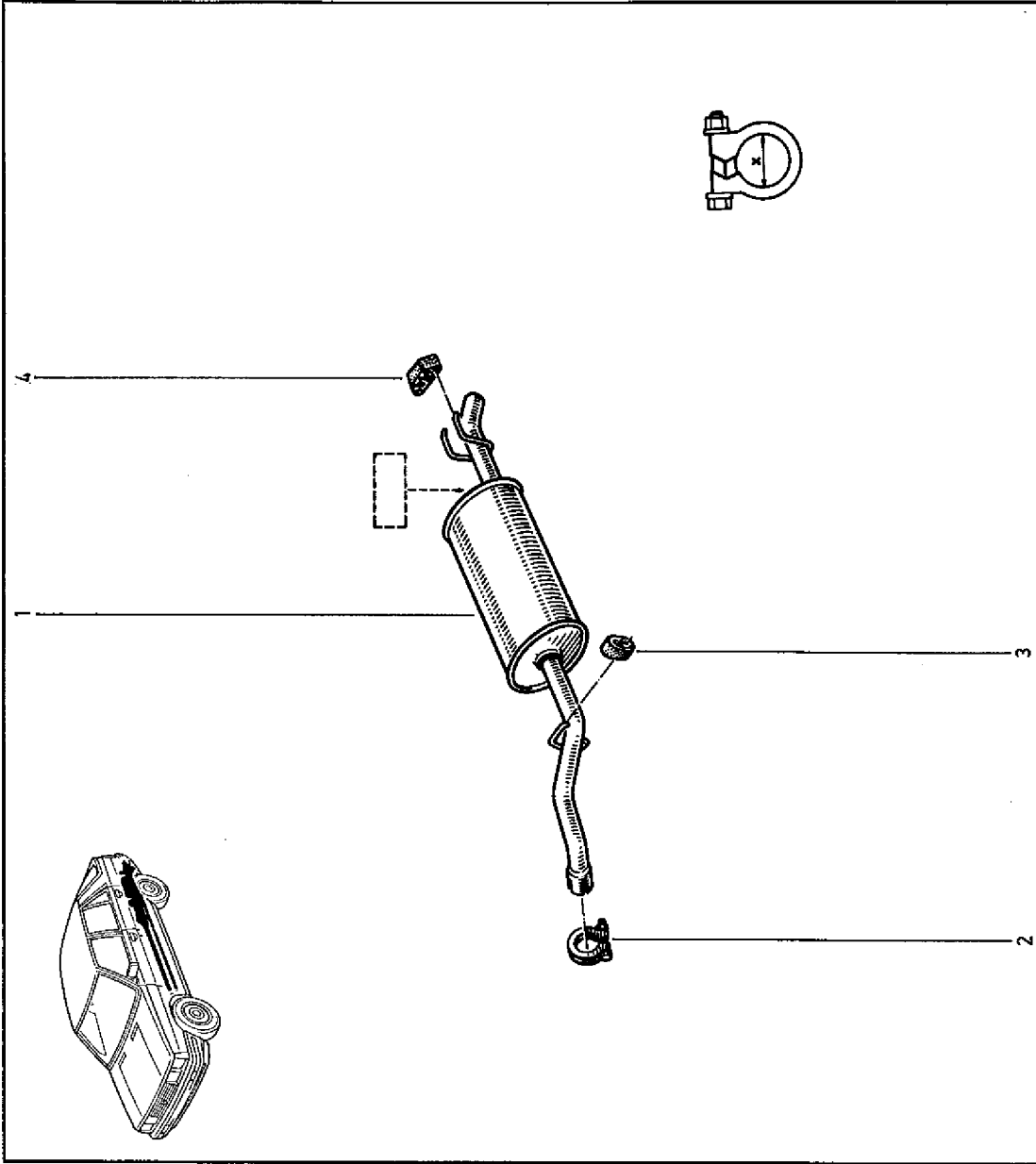



19.80
C.R.1037

- 1 - 77 00 678 814
- 2 - 77 03 019 065
- 3 - 77 03 058 067
- 4 - 77 04 001 320
- 5 - 06 08 540 700
- 6 - 77 03 034 019
- 7 - 77 00 678 815
- 8 - 77 00 752 431
- 9 - 77 00 760 510 +
- 10 - 79 03 053 050
- 11 - 77 00 762 432 +
- 12 - 77 00 752 432
- 13 - 50 03 001 193
- 14 - 77 04 001 319 +
- 15 - 77 00 762 721
- 16 - 77 03 101 045
- 17 - 77 00 757 086 (B-375)
- 18 - 77 03 019 091 (B-375)
- 19 - 77 00 718 102 (B-375)
- 19 - 77 00 757 085 (B-375)

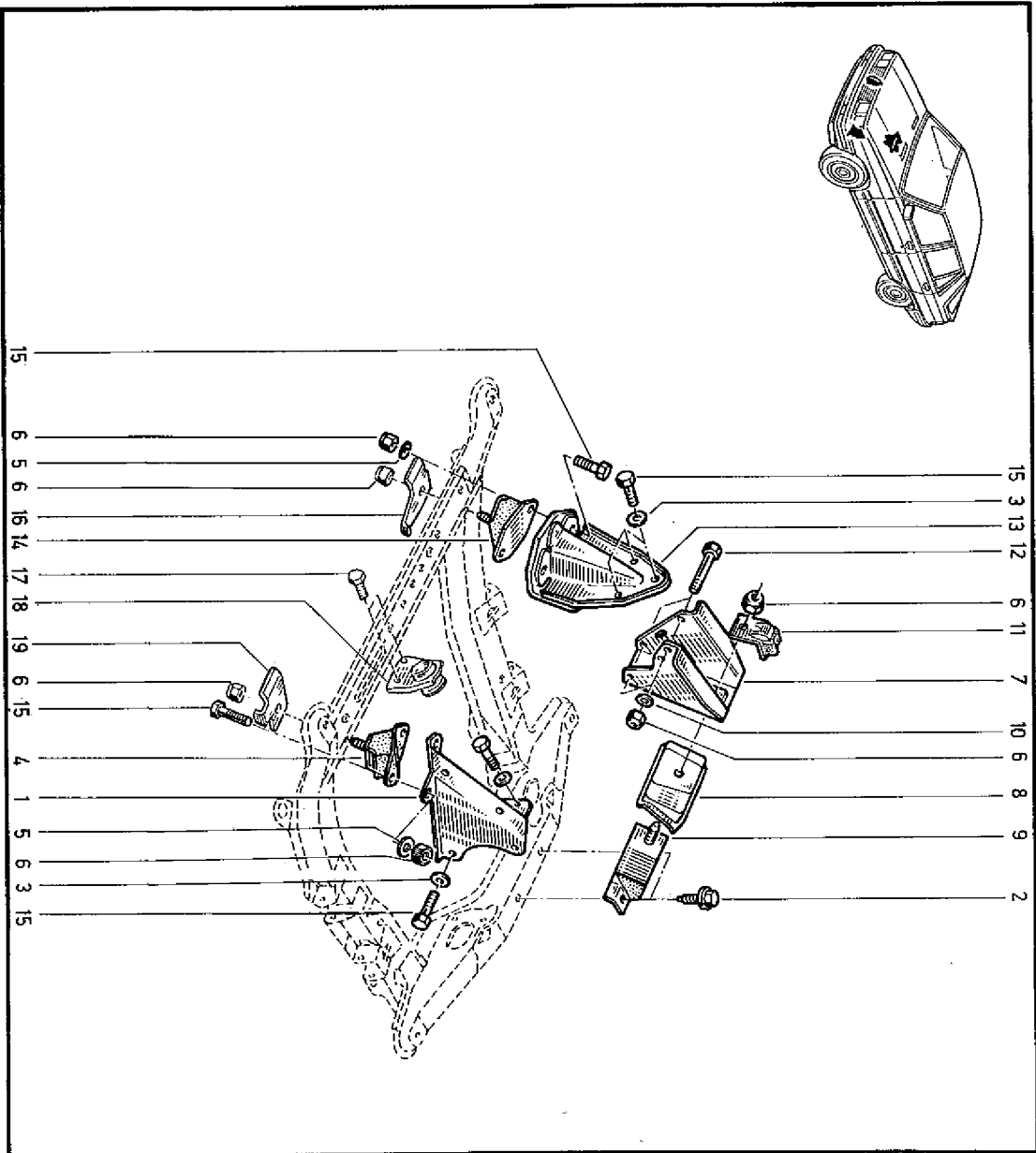

19.80
C.R.1037



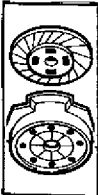

20.01
C.R.1037

- 1 - 77 00 698 011 (x:180)
- 77 00 724 305 (x:180)
- 77 02 058 879 (x:180)
- 77 00 729 385 (B-375) †
- 77 00 739 634 (B-375) † (x:200)
- 77 02 058 951 (B-375)(a) (x:200)
- 2 - 77 01 348 914
- 77 02 058 744
- 77 00 727 965 (B-375) †
- 77 02 096 013 (B-375)(a)
- 77 00 734 610 (B-375)
- 3 - 77 03 001 138
- 77 03 009 124 (B-375)
- 4 - 77 03 055 022
- 79 03 053 043 (B-375)
- 5 - 77 04 001 430 †
- 77 00 725 237 †
- 77 02 058 905
- 6 - 77 03 053 036

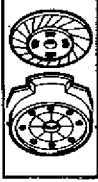

20.01
C.R.1037

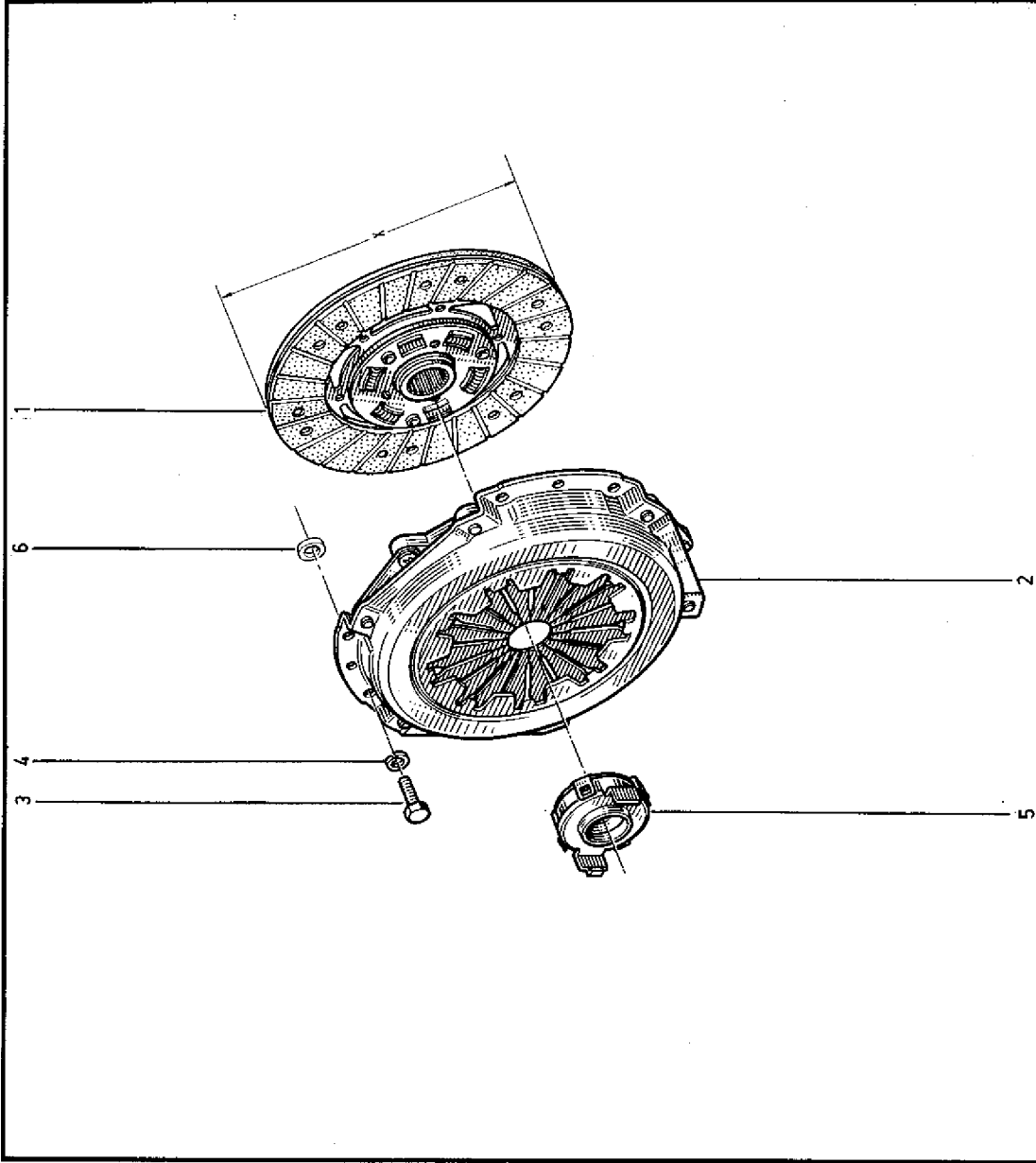

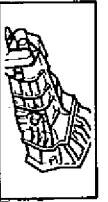

21.01
C.R.1037

- 1 - 77 02 058 893 ISL
- 2 - 77 02 058 895 ISL
- 3 - 77 02 058 949 ISL (B-375)
- 4 - 77 02 096 113 ISL (a)

(a) Δ HE1600 C.C. 8371 $\frac{1}{2}$ n° 1 \rightarrow n°

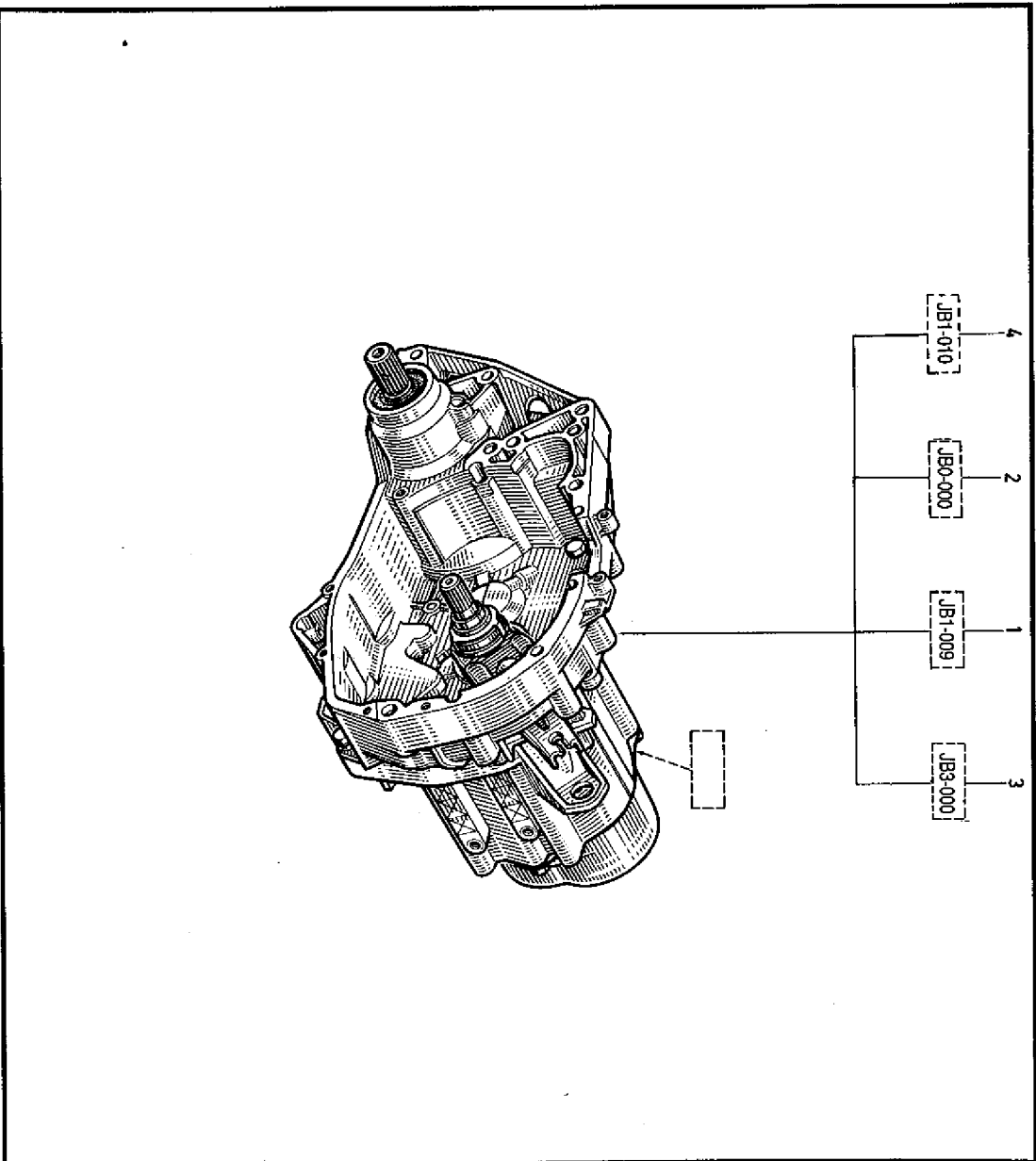

21.01
C.R.1037



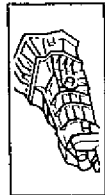

21.20
C.R.1037

JB0 JB1 JB3

21.20
C.R.1037



- 1 - 77 01 463 500 (a) (c) †
- 77 02 058 956 (b) (d) (80) †
- 77 02 096 009 (b) (d) (g) (85) †
- 77 01 463 888 (b) (d) (g) (85)
- 77 02 096 065 (h)
- 77 00 725 865 (JB3) †
- 77 00 733 336 (JB3) (g) (85)
- 77 00 737 536 (JB3) (k)
- 2 - 77 03 075 033
- 3 - 77 00 697 780
- 4 - 77 00 710 633
- 77 00 720 971
- 5 - 77 00 690 380 (a) (8)
- 6 - 77 04 002 415
- 7 - 77 00 695 038 (8)
- 77 77 720 828 (e) (8)
- 77 00 722 801 (f) (8)
- 8 - 77 03 002 008
- 9 - 77 03 002 011
- 10 - 06 08 420 300
- 11 - 77 01 493 033
- 12 - 77 03 002 010
- 13 - 77 04 000 179
- 14 - 78 30 197 000
- 77 03 075 152
- 77 02 027 226
- 15 - 79 03 062 003
- 16 - 77 02 058 941
- 17 - 77 05 030 130
- 18 - 77 00 725 868 (b) (8)
- 77 00 737 467
- 19 - 08 540 099 800 (JB3)

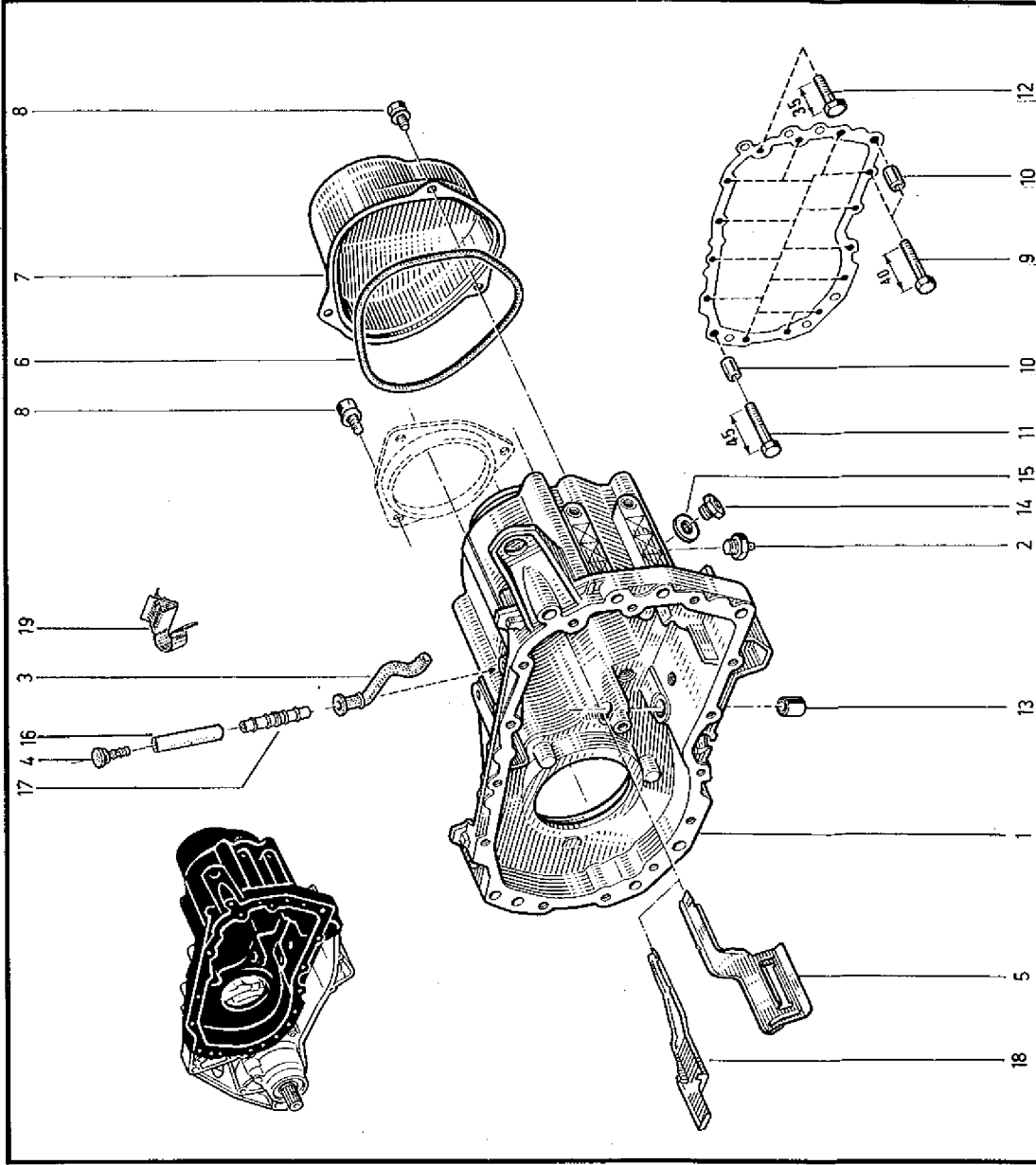

(a)	B373	1	□	1471
(b)	B373	1	□	2248
(c)	B372	1	□	1470
(d)	B372	1	□	1471

(e)	B373	1	□	1471
(f)	B373	1	□	1472
(g)	JB0-000	1	→	801
(h)	JB1-009	1	→	49401
(i)	JB1-010	1	→	49401
(k)	JB3-000	1	→	800

(80)	JB1-JB3	49402	→	801
(85)	JB0-JB1	801	→	801

(80)	JB1-JB3	77 00 725 868-1
(85)	JB0-JB1	77 03 090 381-2
		JB3 77 03 090 382-2



21.30
C.R.1037

- 1 - 77 01 463 265 +
 - 77 01 463 651 (b)
 - 77 00 725 683 (b) +
 - 77 00 727 170 (b)
 - 77 00 737 559 (c)
 - 77 00 732 133 (a)(b)
 - 77 00 737 560 (a)(c)
- 2 - 77 04 001 334
- 3 - 77 00 682 261
- 4 - 77 00 717 259 (a)
- 5 - 77 00 688 654
- 6 - 77 05 010 017
- 7 - 77 03 001 196
- 8 - 77 00 663 500
- 9 - 77 03 002 008
- 10 - 77 00 704 958
- 11 - 77 03 027 195 (x = 100)
- 12 - 77 03 027 187 (x = 120)
- 13 - 77 05 010 087 (x = 11,35)
- 14 - 77 03 075 152
- 15 - 79 03 062 003
- 16 - 77 03 053 294
- 17 - 79 03 032 023
- 18 - 77 03 051 937 (a)
- 19 - 77 03 001 878 (a)
- 19 - 77 03 058 064 (a)

JBO JB1 JB3

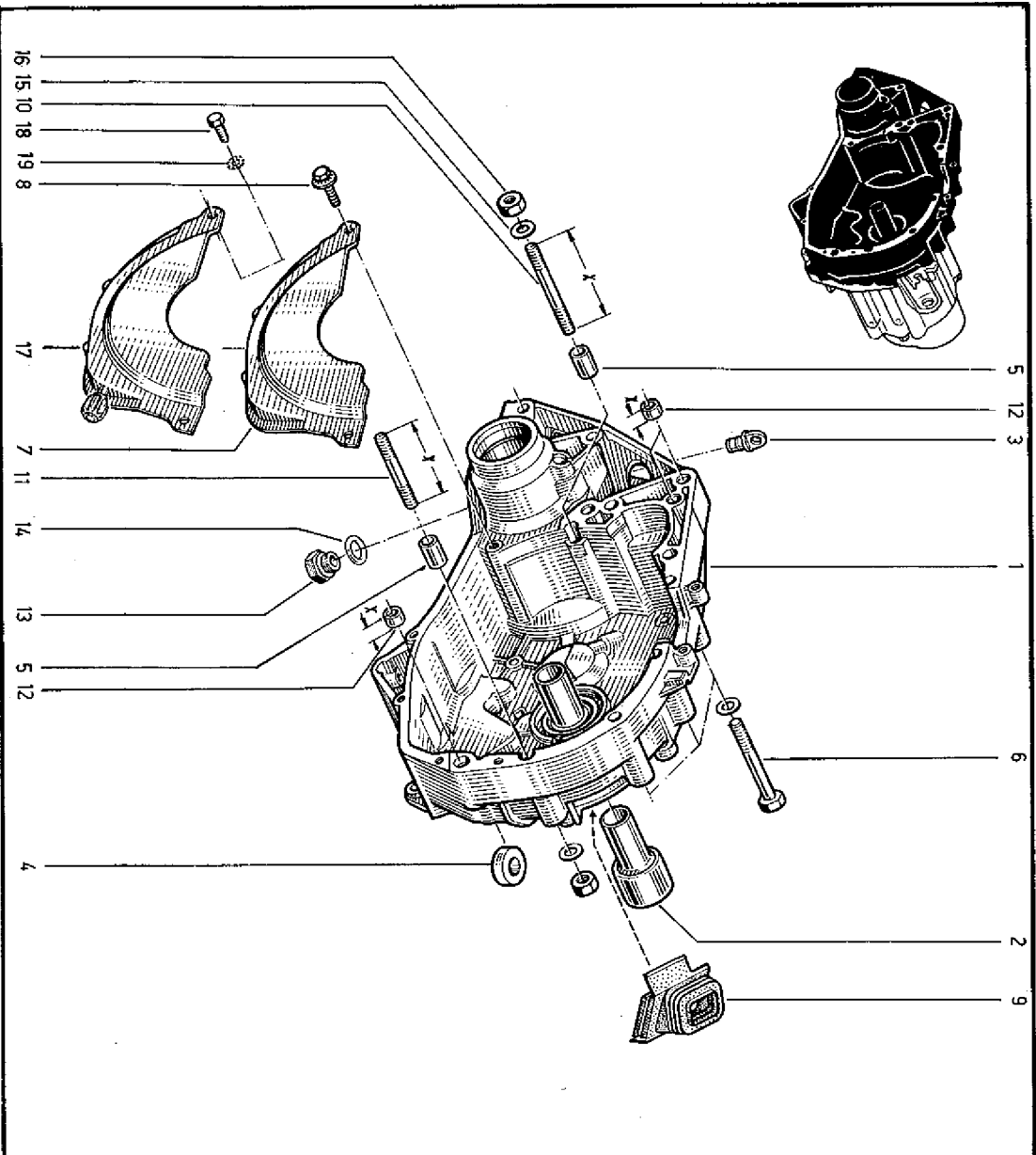

21.30
C.R.1037



(a) JBO JB3

JBO-000 \rightarrow n° 1 \rightarrow n° 49401
JB1-009 \rightarrow n° 1 \rightarrow n° 800
JB3-000 \rightarrow n° 1 \rightarrow n° 800

JB1-009 \rightarrow n° 49402 \rightarrow n°
JB1-010 \rightarrow n° 1 \rightarrow n°
JB3-000 \rightarrow n° 801 \rightarrow n°

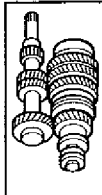

21.40
C.R.1037

- 1 - 77 00 727 390 (c)
- 2 - 77 00 728 823 (d)
- 3 - 77 03 090 282
- 4 - 77 00 706 549
- 5 - 77 01 462 328
- 6 - 77 00 718 963
- 7 - 77 01 462 325
- 8 - 77 00 685 833
- 9 - 77 00 667 703
- 10 - 77 00 708 152
- 11 - 77 00 720 886
- 12 - 77 04 000 446
- 13 - 77 00 678 565
- 14 - 77 00 688 653
- 15 - 77 00 725 962
- 16 - 77 03 090 338 (b) (x = 17,5)
- 17 - 77 03 090 329 (a) (x = 17)
- 18 - 77 00 720 885
- 19 - 77 00 724 559 (a) (x = 20,1)
- 20 - 77 01 462 293
- 21 - 77 01 462 576
- 22 - 77 03 090 381 (x = 17,5)

21.40
C.R.1037

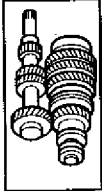

J80 000

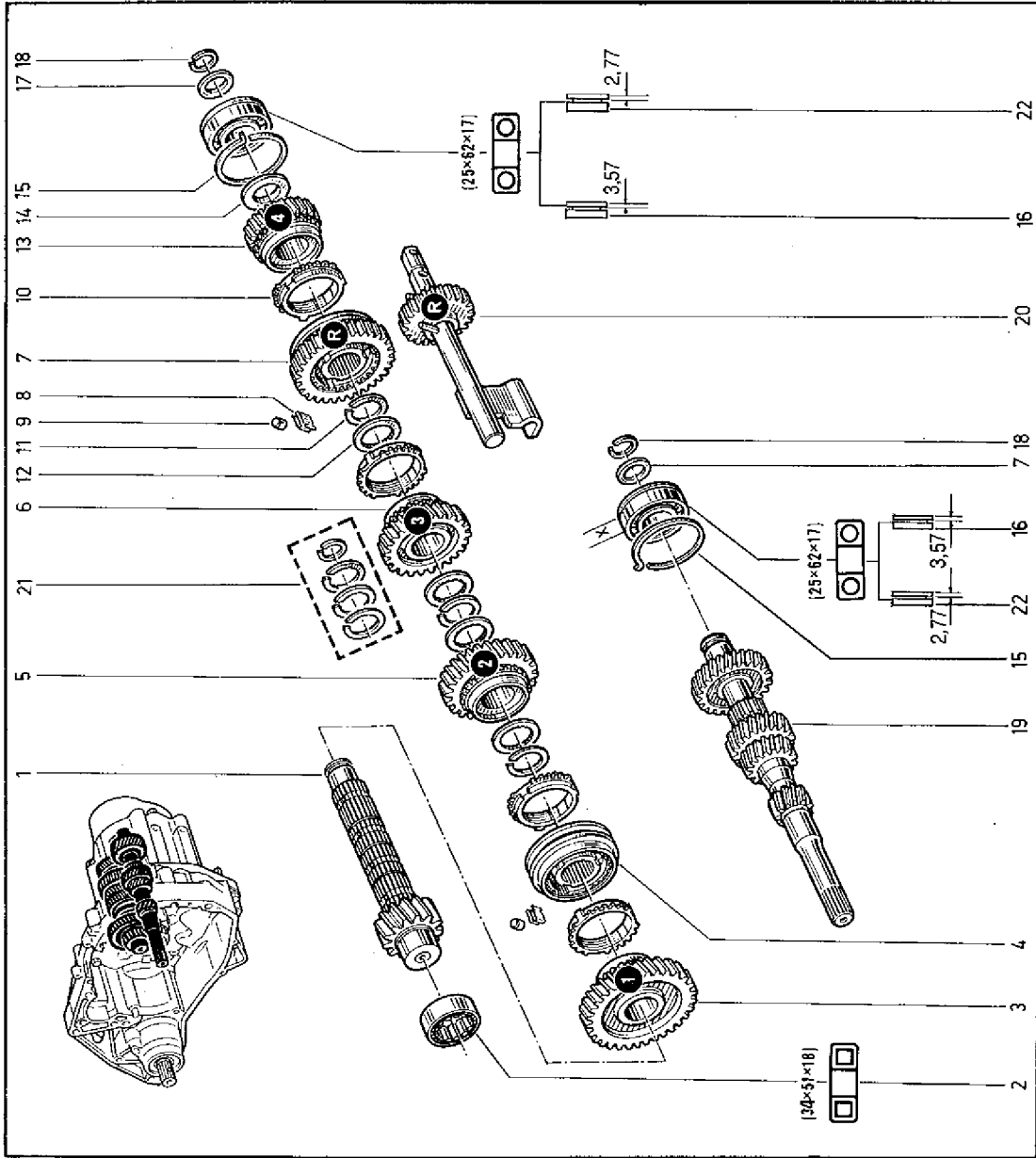

(a) / 372	n°	1	n° 1470
(b) / 372	n°	1	n°
(c) / 372	n°	1	n° 01630
(d) / 372	n°	1	n° 01631

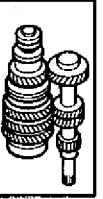

21.45
C.R.1037

□ JB1-JB3

21.45
C.R.1037

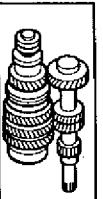

1 - 77 00 720 526	26 - 77 01 462 293 (e)
2 - 77 03 090 323	27 - 77 00 720 240 (f)
3 - 77 00 706 549	28 - 77 00 723 507 (x = 42)
4 - 77 01 462 328	29 - 77 01 462 576 (x = 27)
5 - 77 00 718 963	30 - 77 00 723 167
6 - 77 00 678 564	31 - 77 03 090 382 (a) (x = 17.5)
7 - 77 01 462 325	77 03 090 391 (d) (x = 17.5)
8 - 77 00 685 833	
9 - 77 00 667 703	
10 - 77 00 708 152	
11 - 77 00 720 886	
12 - 77 04 000 446	
13 - 77 00 718 961	
14 - 77 00 688 653	
15 - 77 03 066 288 †	
16 - 77 03 090 278 †	
77 03 090 329 (x = 17) (b)	
77 03 090 338 (x = 17.5) (c)	
77 03 090 334 (a) †	
77 03 090 339 (a)	
17 - 77 00 720 350 (x = 16.5) (b)	
77 00 727 849 (x = 16) (c)	
77 00 727 306 (a)	
18 - 77 00 718 956	
77 00 731 151 (a) † (85)	
77 00 794 608 (a)	
19 - 77 00 680 261 (x = 6) (b)	
77 00 727 851 (x = 5.5) (c)	
20 - 77 05 010 034	
21 - 77 03 090 312	
22 - 77 00 720 396	
77 00 678 568 (a)	
23 - 77 00 656 205	
24 - 77 01 462 326	
25 - 77 03 034 082	

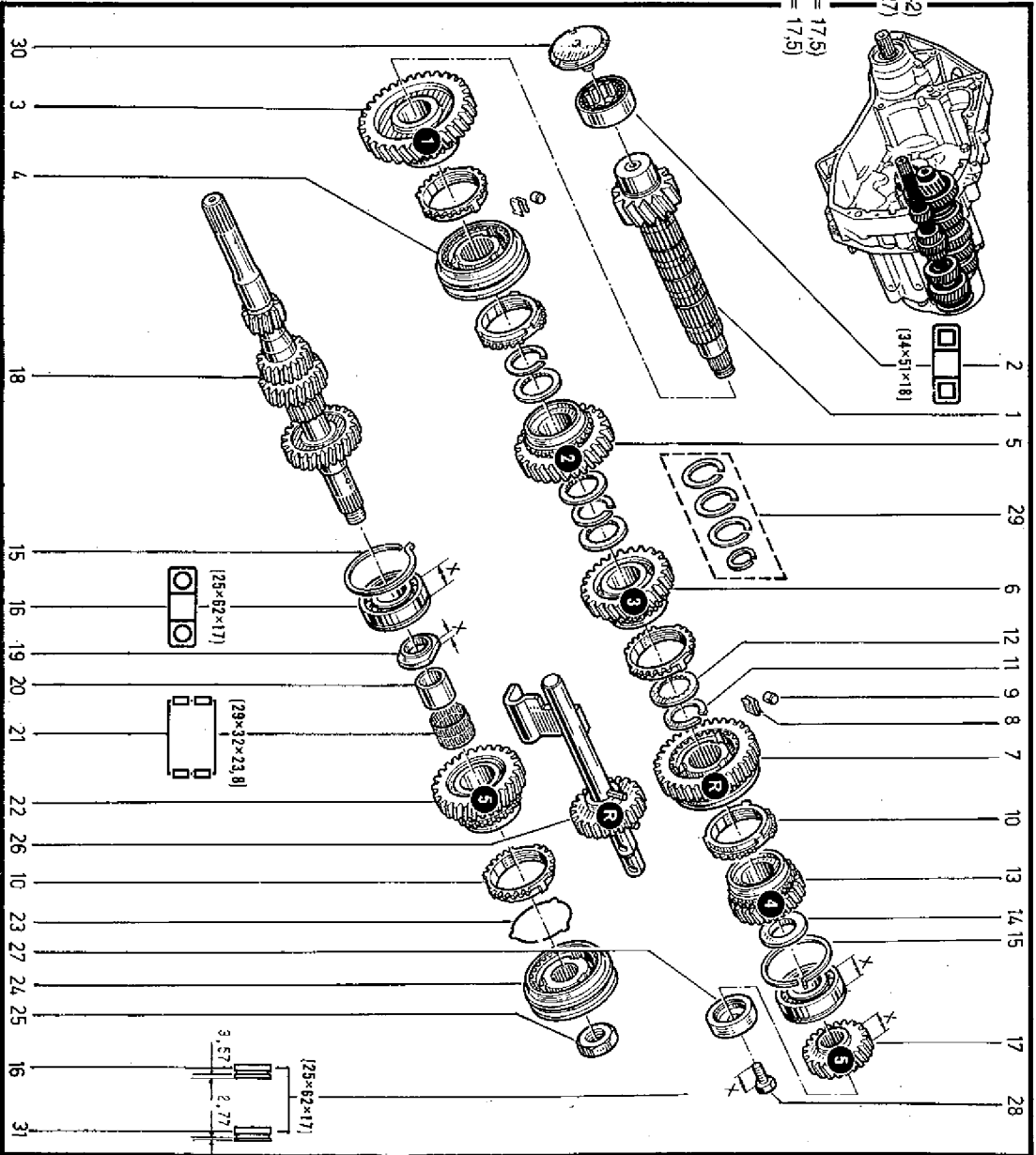

(a)	JB3	1	2248
(b)	B-373	n°	→ n°
(c)	B-373	n° 2249	→ n°
(d)	B-373		

(e)	JB1-009	1	49401
(f)	JB3-000	1	800
(g)	JB1-009	n° 49402	→ n°
(h)	JB1-010	1	n°
(i)	JB3-000	n° 801	→ n°

(85)	77 00 734 608-1
	77 00 734 609-1
(95)	77 00 734 609-1



21.50
C.R.1037

- 1 - 77 00 724 558 (* = 61) (a)
- 2 - 77 00 723 654 (b)
- 3 - 77 00 664 915
- 4 - 77 03 061 105
- 5 - 77 00 611 935
- 6 - 77 00 518 646
- 7 - 77 00 724 459 (a) (c)
- 8 - 77 08 725 208 (a) (c)
- 9 - 77 08 725 209 (a) (c)
- 10 - 77 00 724 925 (c)
- 11 - 77 00 721 610 (d)
- 12 - 77 00 720 854
- 13 - 77 03 066 331
- 14 - 77 03 065 128
- 15 - 77 03 087 114
- 16 - 77 03 087 138
- 17 - 77 03 087 146
- 18 - 77 03 066 327 (x = 2,5)
- 19 - 77 03 090 316
- 20 - 77 03 066 326
- 21 - 77 00 664 119 (* = 21)
- 22 - 77 03 090 280 †
- 23 - 77 03 090 324
- 24 - 77 00 723 394 (x = 1,4)
- 25 - 77 00 747 129 (x = 1,4)
- 26 - 77 03 053 561 (x = 0,4)
- 27 - 77 00 722 303 (* = 19)
- 28 - 77 00 722 304
- 29 - 77 00 684 501 †
- 30 - 77 00 729 283
- 31 - 77 00 722 023 (b)
- 32 - 77 00 680 811 (b)
- 33 - 77 05 015 166 (b)
- 34 - 77 03 090 324 †
- 35 - 77 03 090 417
- 36 - 77 00 717 366 (d)
- 37 - 77 03 067 069 (d)
- 38 - 77 00 717 385 (d)

JB0 , JB1 , JB3

21.50
C.R.1037

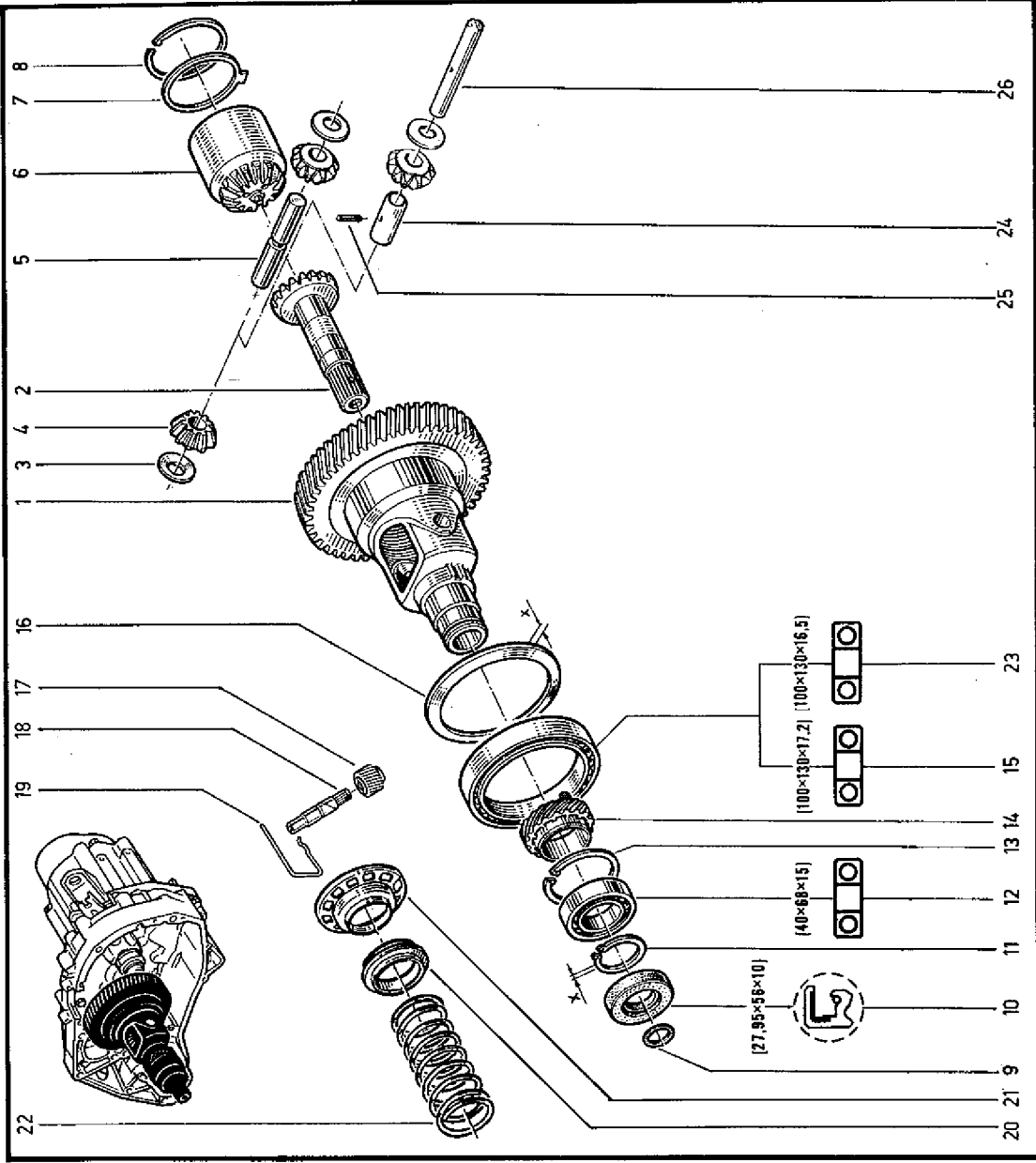

(a) / □	B372	n°	1	n°	7945
(b) / □	B373	n°	1	n°	16378
(c)	B375	n°	1	n°	287

B372	n°	7946	n°
B373	n°	16380	n°
B375	n°	288	n°
B37E	n°	01	n°
B37G	n°	01	n°

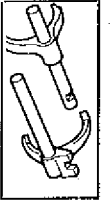

21.60
C.R.1037

- 1 - 77 00 679 960
- 2 - 77 03 087 115 +
- 77 03 087 163
- 3 - 77 03 067 030
- 4 - 77 03 067 137
- 5 - 77 00 648 234
- 6 - 77 00 679 967
- 7 - 77 05 015 138
- 8 - 77 03 090 215
- 9 - 77 00 725 904
- 10 - 77 03 067 082
- 11 - 77 00 725 719 +
- 77 00 660 488
- 12 - 77 00 715 851
- 13 - 77 00 722 940
- 14 - 77 00 703 000
- 15 - 77 00 725 987
- 16 - 77 00 708 440 +
- 77 00 730 387
- 77 00 737 244
- 17 - 77 03 066 329
- 18 - 77 00 697 108 +
- 77 00 730 387
- 77 00 737 244
- 19 - 77 00 702 321 (X = 22)
- 77 00 725 846 (X = 21,3)
- 20 - 77 00 648 232
- 21 - 77 00 678 810
- 22 - 77 00 678 780
- 23 - 77 00 718 856

□ J.80-000

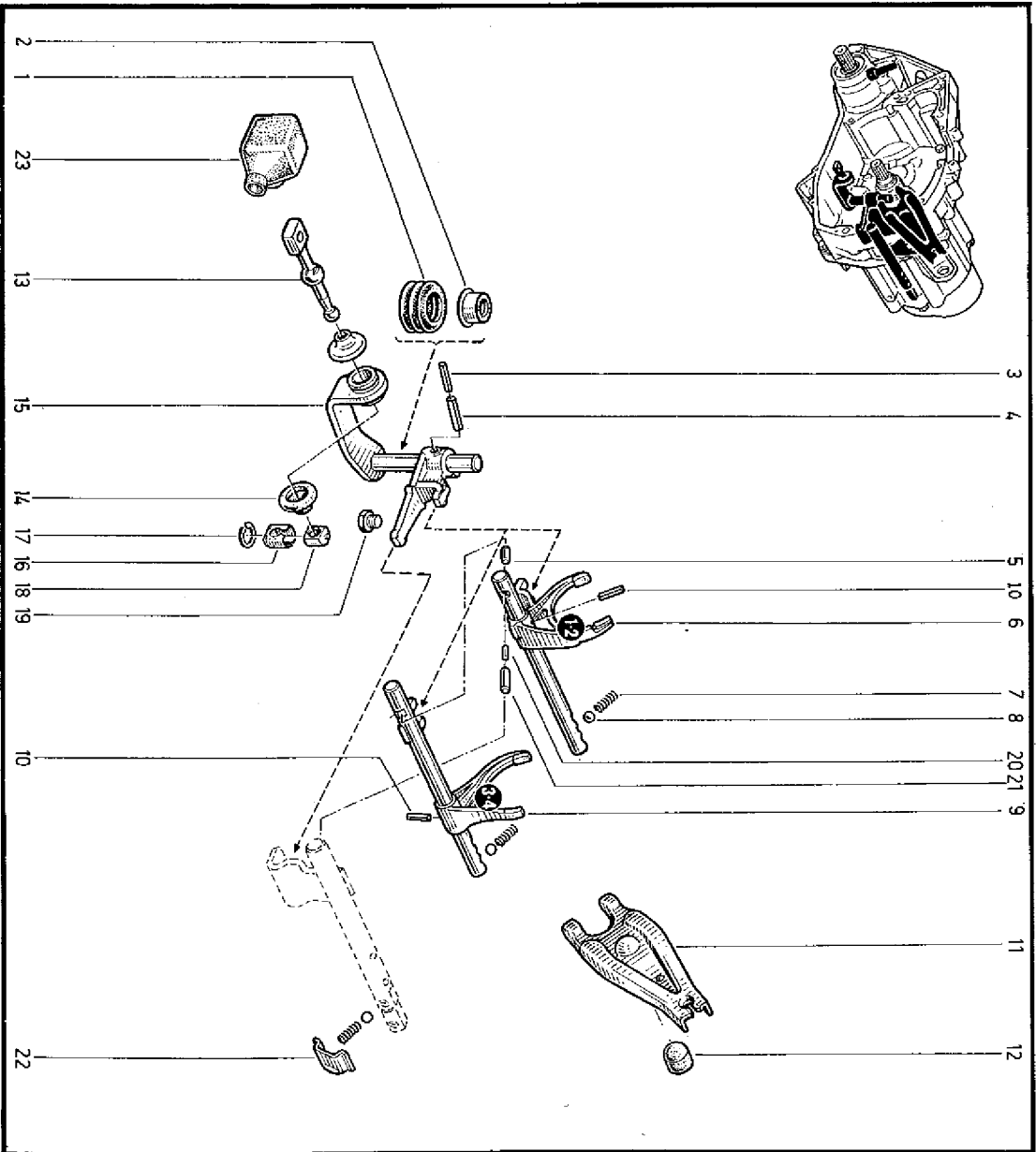

21.60
C.R.1037

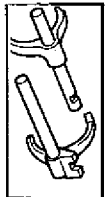

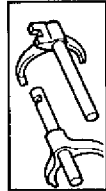

21.65
C.R.1037

JB1 JB3

21.65
C.R.1037

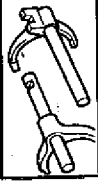

- 1 - 77 00 679 960
- 2 - 77 03 087 115 †
- 3 - 77 03 087 163
- 4 - 77 03 067 030
- 5 - 77 03 067 137
- 6 - 77 00 648 234
- 7 - 77 00 679 967
- 8 - 77 00 743 722
- 9 - 77 05 015 138
- 10 - 77 03 090 215
- 11 - 77 00 725 904
- 12 - 77 03 067 082
- 13 - 77 00 660 487 †
- 14 - 77 00 660 488
- 15 - 77 00 725 720 (a)
- 16 - 77 00 715 851
- 17 - 77 00 722 940
- 18 - 77 00 703 000
- 19 - 77 00 725 987
- 20 - 77 00 708 440 †
- 21 - 77 00 730 387
- 22 - 77 03 066 329
- 23 - 77 00 697 108 †
- 24 - 77 00 730 387
- 25 - 77 01 463 223
- 26 - 77 00 723 388
- 27 - 77 00 648 232
- 28 - 77 00 678 810 (a)
- 29 - 77 00 736 437 (b)
- 30 - 77 00 725 911
- 31 - 79 03 067 011
- 32 - 77 00 678 780 (a)
- 33 - 77 00 736 438 (b)
- 34 - 77 00 718 856
- 35 - 77 03 053 605 (x = 0,33)
- 36 - 77 03 053 606 (x = 0,66)
- 37 - 77 00 715 852

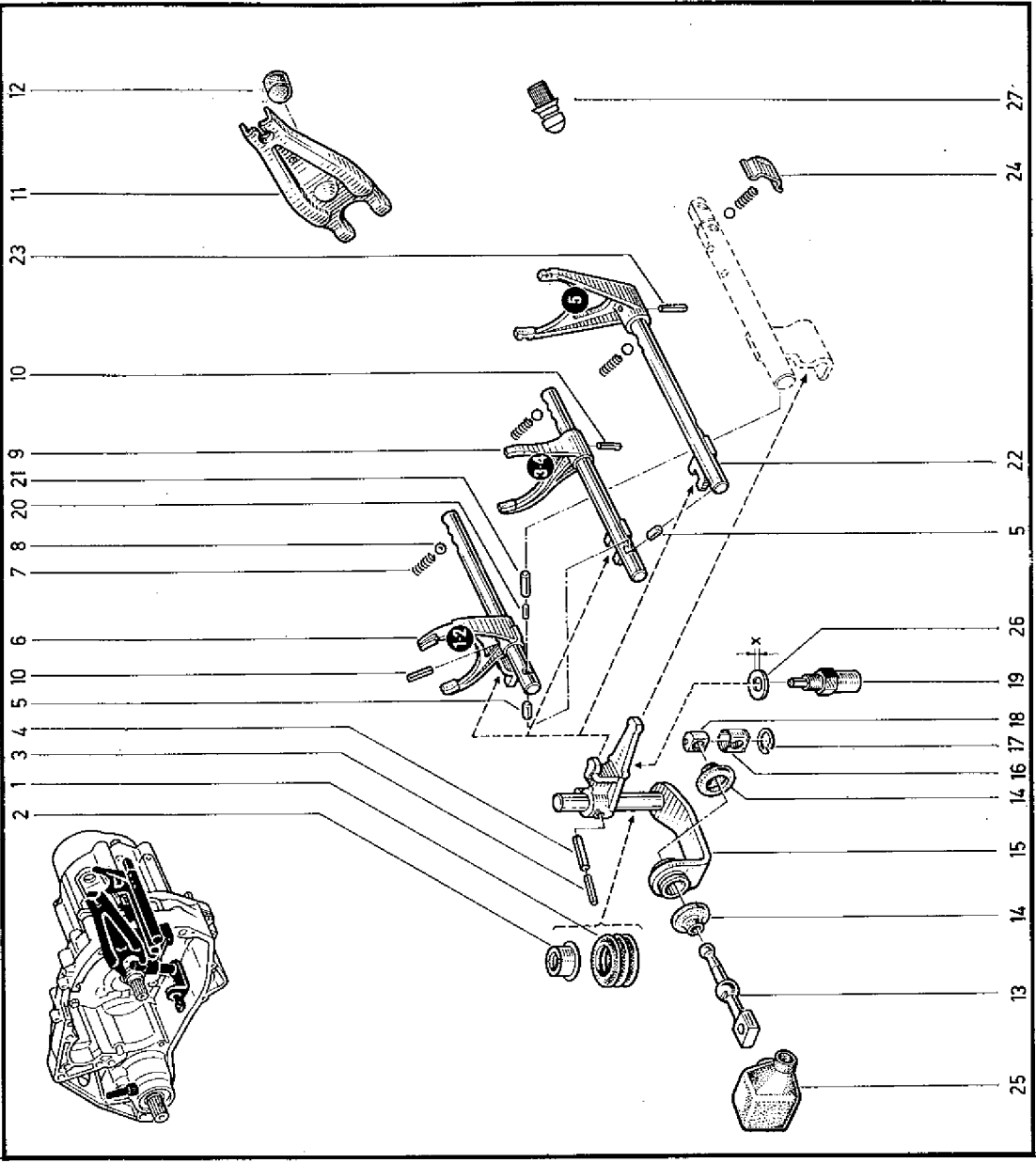

(a)	JB1 - 009 n°	1	→	n° 49401
	JB3 - 000 n°	1	→	n° 800
(b)	JB1 - 009 n°	49402	→	n°
	JB1 - 010 n°	1	→	n°
	JB3 - 000 n°	801	→	n°

(a) JB1-010
JB3-000

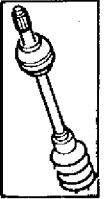

29.01
C.R.1037

- 1 - 77 01 349 359 (B) †
- 2 - 77 00 684 343 (B) (B-375)
- 3 - 77 01 462 100
- 4 - 77 00 531 733 (C) †
- 5 - 77 03 066 007 (C)
- 6 - 77 01 018 691
- 7 - 77 01 349 660 (A) †
- 8 - 77 00 684 403 (A) (B-375)
- 9 - 77 03 087 207
- 10 - 77 01 018 692
- 11 - 77 01 462 101 (X=79)
- 12 - 77 00 678 722
- 13 - 77 01 348 568
- 14 - 79 03 067 016
- 15 - 77 01 463 586 (B-375)

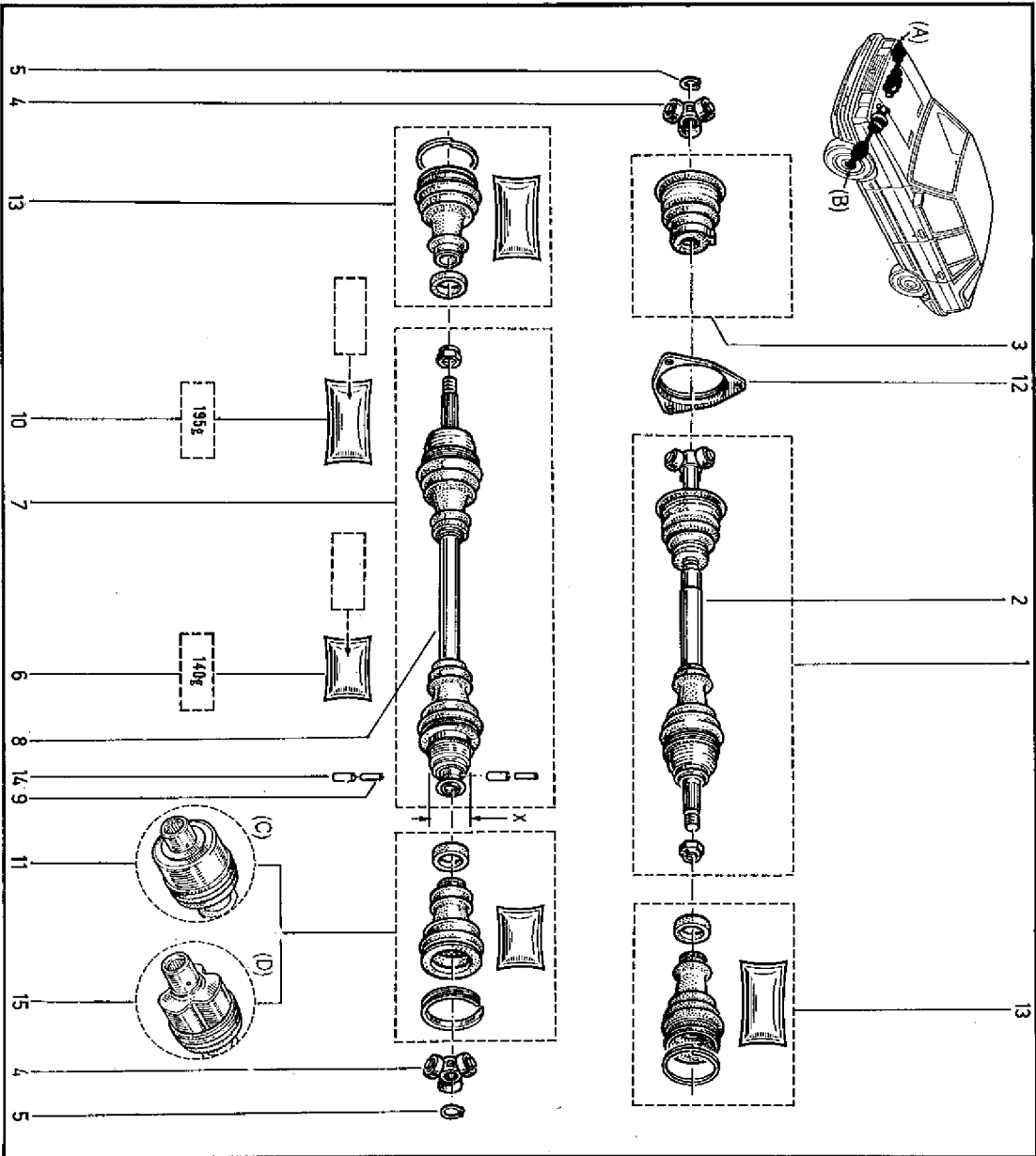

29.01
C.R.1037



(a) / B372
B373
B37E
B37G



31.01
C.R.1037

- 1 - 77 00 773 259 † (20)
- 2 - 77 02 094 089 †
- 3 - 77 02 093 951
- 4 - 77 02 094 403
- 5 - 77 03 019 065 † (X=10)
- 6 - 77 02 074 081 X=12
- 7 - 77 03 019 120 (X=10)
- 8 - 77 03 001 921
- 9 - 77 03 101 145
- 10 - 77 00 706 206
- 11 - 77 03 034 031 †
- 12 - 77 03 034 104
- 13 - 77 02 081 071
- 14 - 77 04 000 681
- 15 - 77 00 698 917
- 16 - 77 03 053 071 †
- 17 - 79 03 053 114
- 18 - 77 03 053 071
- 19 - 77 03 034 061
- 20 - 77 02 081 072
- 21 - 77 04 001 634 [E] O
- 22 - 77 02 081 092 [E] O
- 23 - 77 04 001 633 [E] O
- 24 - 77 02 081 093 [E] O
- 25 - 77 04 003 411 [E] (B-375)
- 26 - 77 02 093 580 [E] (B-375)
- 27 - 77 00 709 328
- 28 - 77 02 081 076
- 29 - 77 02 081 075
- 30 - 77 00 678 679
- 31 - 79 03 053 114 (X=12)
- 32 - 77 03 055 015 (X=12)



31.01
C.R.1037

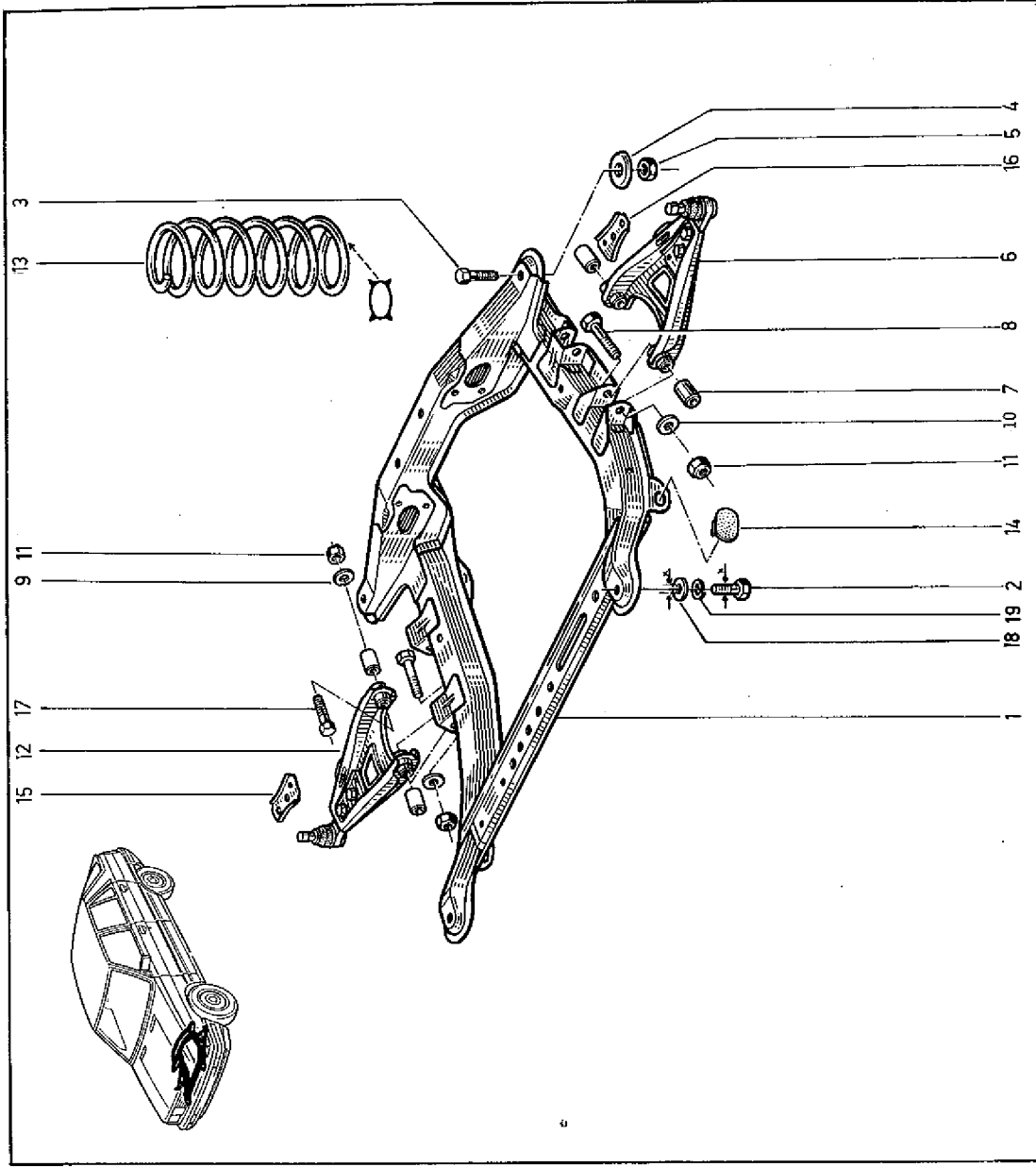

77 02 094 403 -1
77 02 074 081 -2
79 03 053 114 -2
77 03 055 015 -2
(20)



31.30
C.R.1037

- 1 - 77 02 073 815
- 2 - 77 02 081 077
- 3 - 77 03 034 020
- 4 - 77 00 754 196
- 5 - 77 00 678 292
- 6 - 77 03 034 018

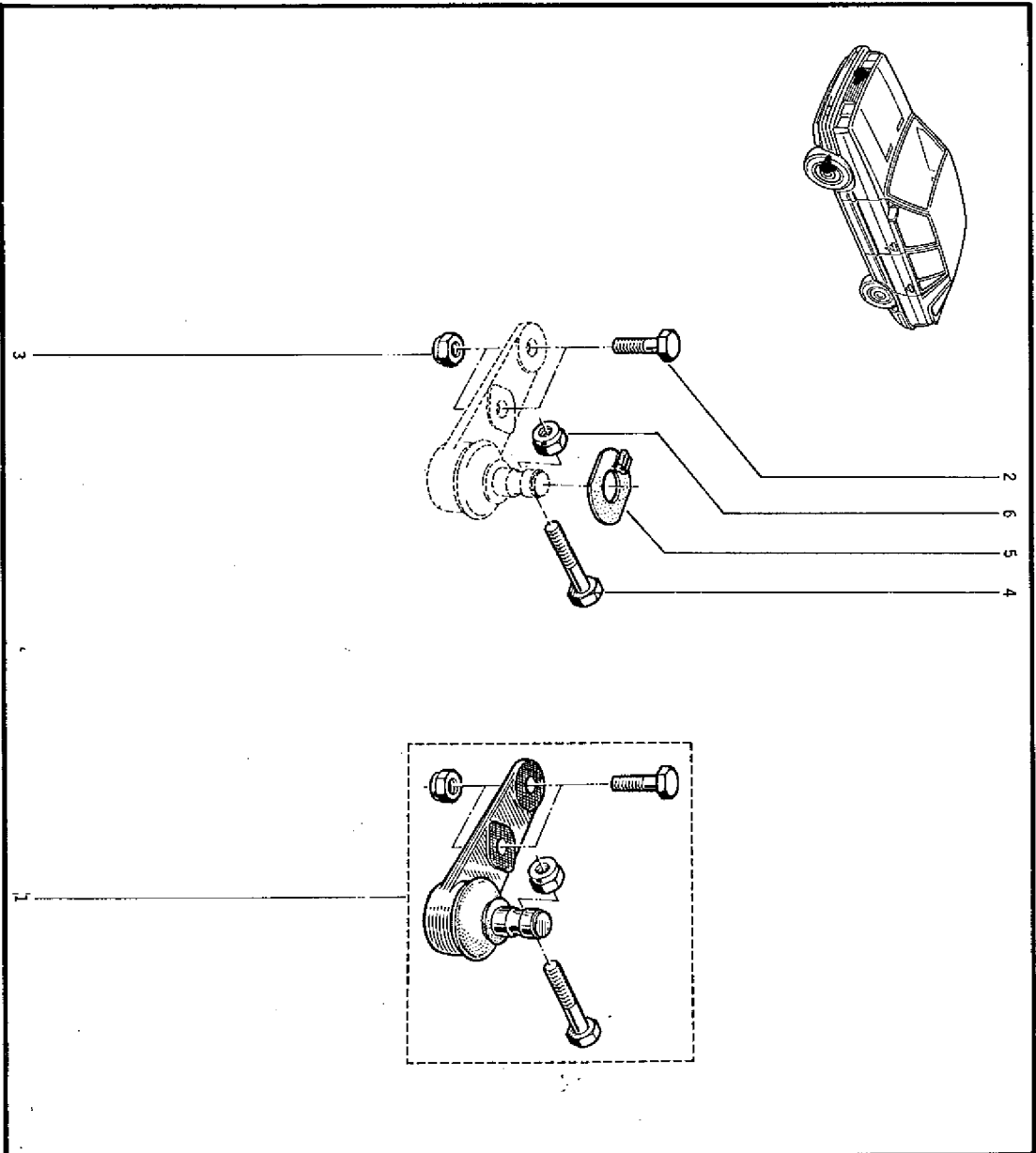

31.30
C.R.1037





31.40
C.R.1037

- 1 - 77 00 677 033
- 2 - 77 03 090 283
- 3 - 77 00 677 758
- 4 - 77 00 677 029
- 5 - 77 00 704 704 †
- 6 - 77 00 752 811
- 7 - 77 00 704 705
- 8 - 77 03 004 128
- 9 - 77 00 759 987
- 10 - 77 03 034 068
- 11 - 77 00 693 172
- 12 - 07 03 019 084
- 13 - 77 00 693 173
- 14 - 77 01 462 469
- 15 - 77 00 756 572 (B-375)



31.40
C.R.1037

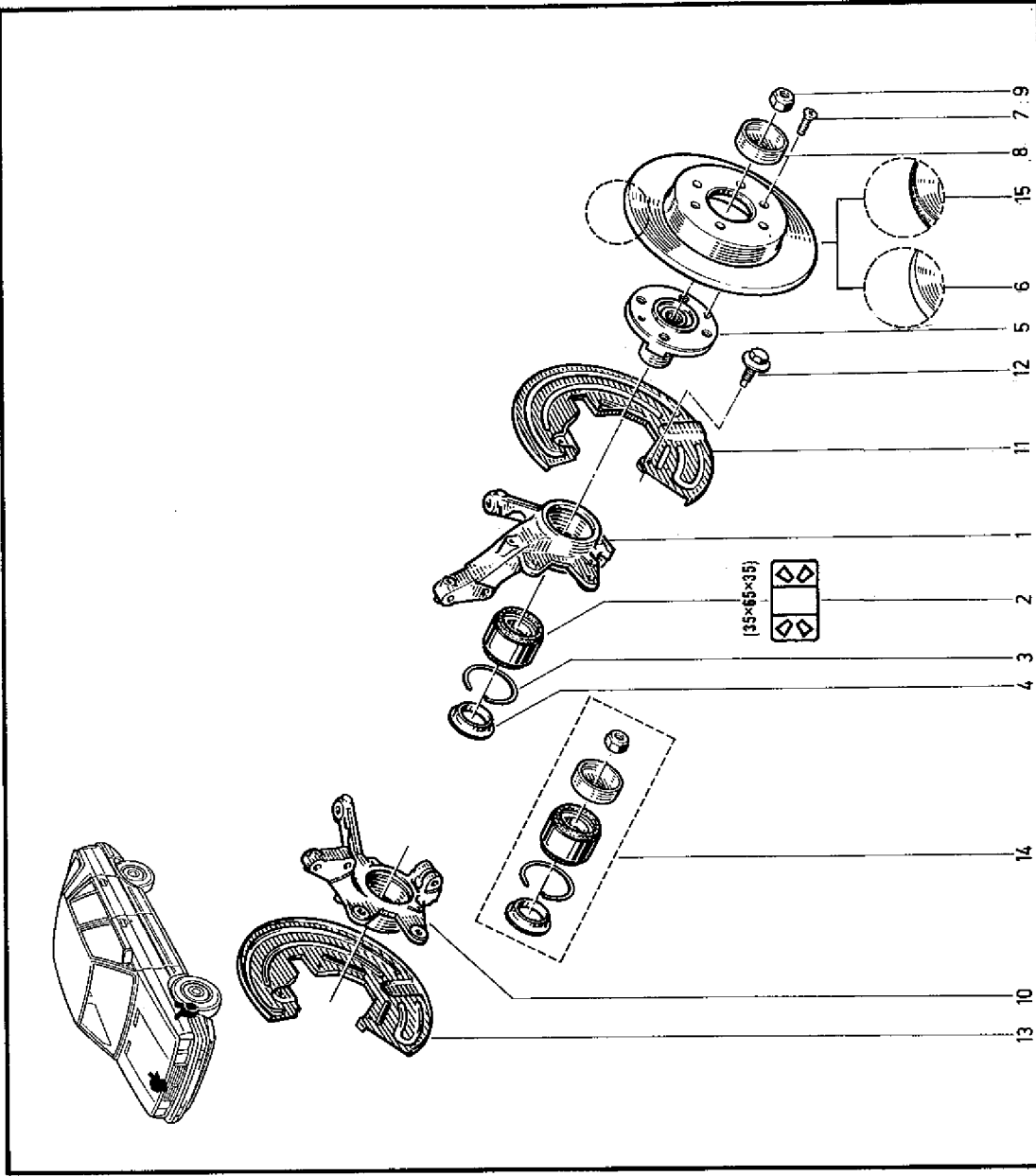

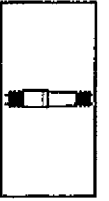

32.01
C.R.1037

- 1 - 77 02 073 382
- 2 - 77 00 678 680
- 3 - 77 03 053 071
- 4 - 77 03 053 114
- 5 - 77 04 000 646
- 6 - 77 00 704 703
- 7 - 77 04 001 257
- 8 - 77 04 001 660
- 9 - 77 00 704 931
- 10 - 77 03 034 014
- 11 - 77 03 019 093
- 12 - 77 04 002 011
- 13 - 77 04 002 292
- 77 02 093 763

+

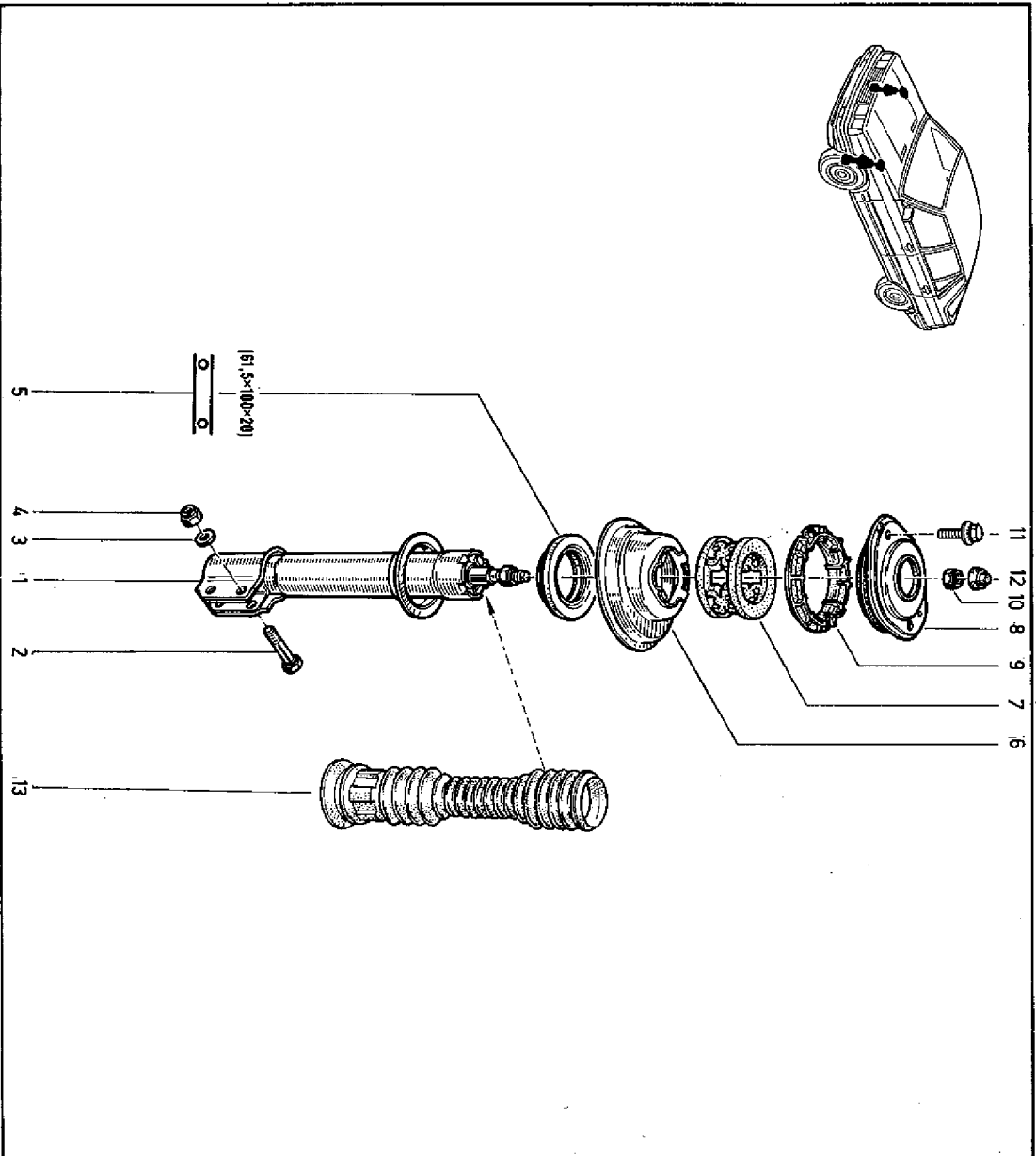

32.01
C.R.1037

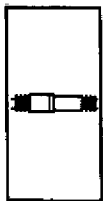



32.10
C.R.1037

- 1 - 77 00 760 452 (x = 23)
- 2 - 77 00 693 155 †
- 3 - 77 00 762 573 (a)
- 4 - 77 02 111 932 (b)
- 5 - 77 00 680 097 (a)
- 6 - 77 02 111 933 (b)
- 7 - 77 03 001 498 (a)
- 8 - 77 03 053 127
- 9 - 77 03 034 011
- 10 - 77 00 760 264
- 11 - 77 00 680 098
- 12 - 77 03 053 292
- 13 - 79 03 032 023
- 14 - 77 00 055 013
- 15 - 77 00 763 871
- 16 - 77 03 101 052 †
- 17 - 77 03 101 076
- 18 - 77 03 001 488 (x = 25)
- 19 - 77 03 001 164 (X = 30)

B372	1	↑	n°	1	↑	n°
B373	1	↑	n°	1	↑	n° 31601
B37E	1	↑	n°	1	↑	n°
B37G	1	↑	n°	1	↑	n° 07935
B37T	1	↑	n°	1	↑	n° 00473
B375	1	↑	n°	1	↑	n° 00760

(a)

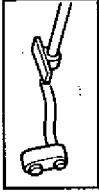

32.10
C.R.1037

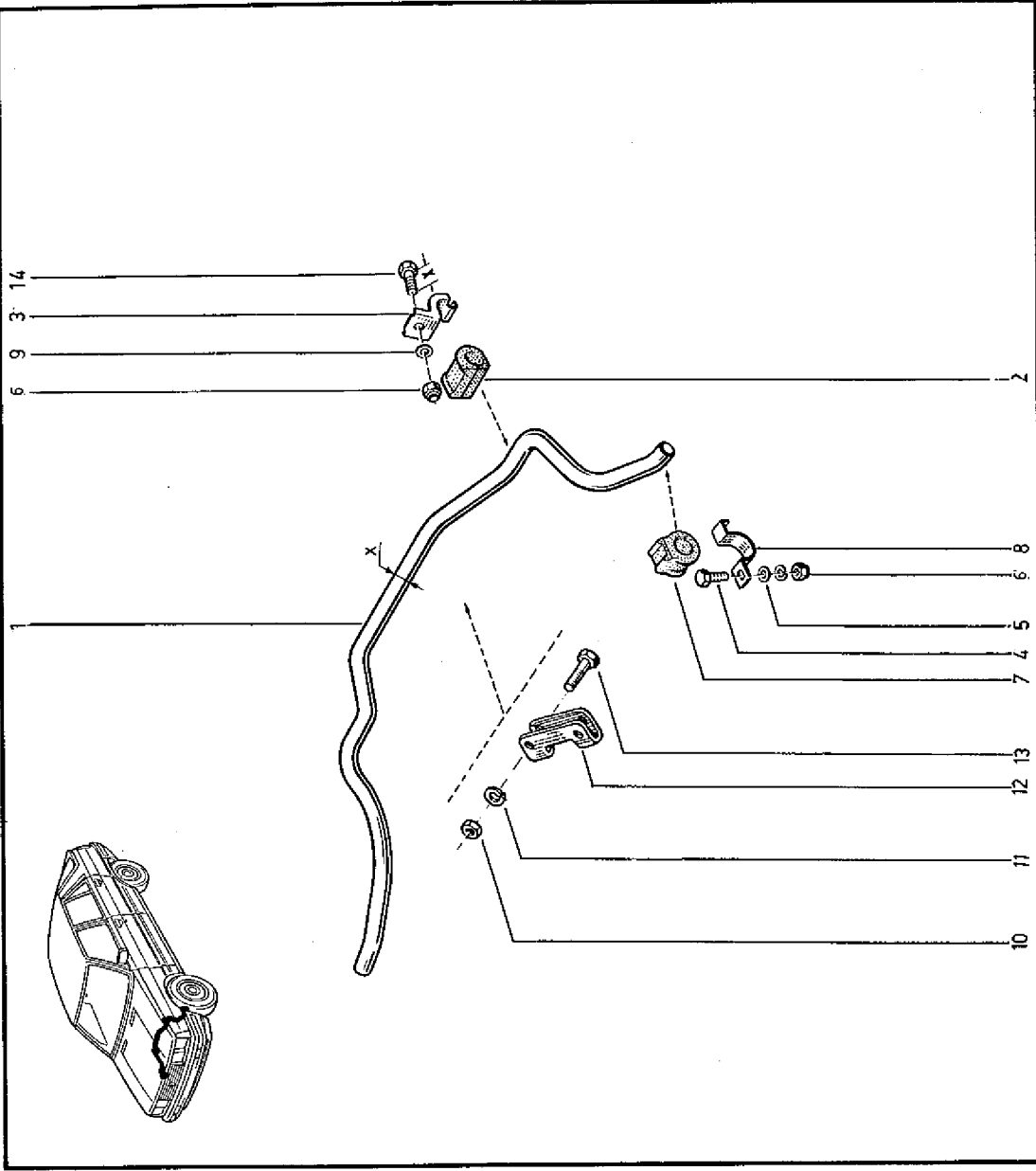

B37G	1	↑	n°	1	↑	n° 07936
B37T	1	↑	n°	1	↑	n° 00474
B373	1	↑	n°	1	↑	n° 31602
B375	1	↑	n°	1	↑	n° 00761

(b)



32.30
C.R.1037

- 1 - 77 02 073 843
- 2 - 77 02 073 844
- 3 - 77 02 073 845
- 4 - 77 01 348 673
- 5 - 77 02 073 847
- 6 - 77 02 073 848
- 7 - 77 02 073 849
- 8 - 77 02 073 850
- 9 - 77 02 073 851
- 10 - 77 02 073 852
- 11 - 77 02 073 853
- 12 - 77 02 073 854
- 13 - 77 00 656 379

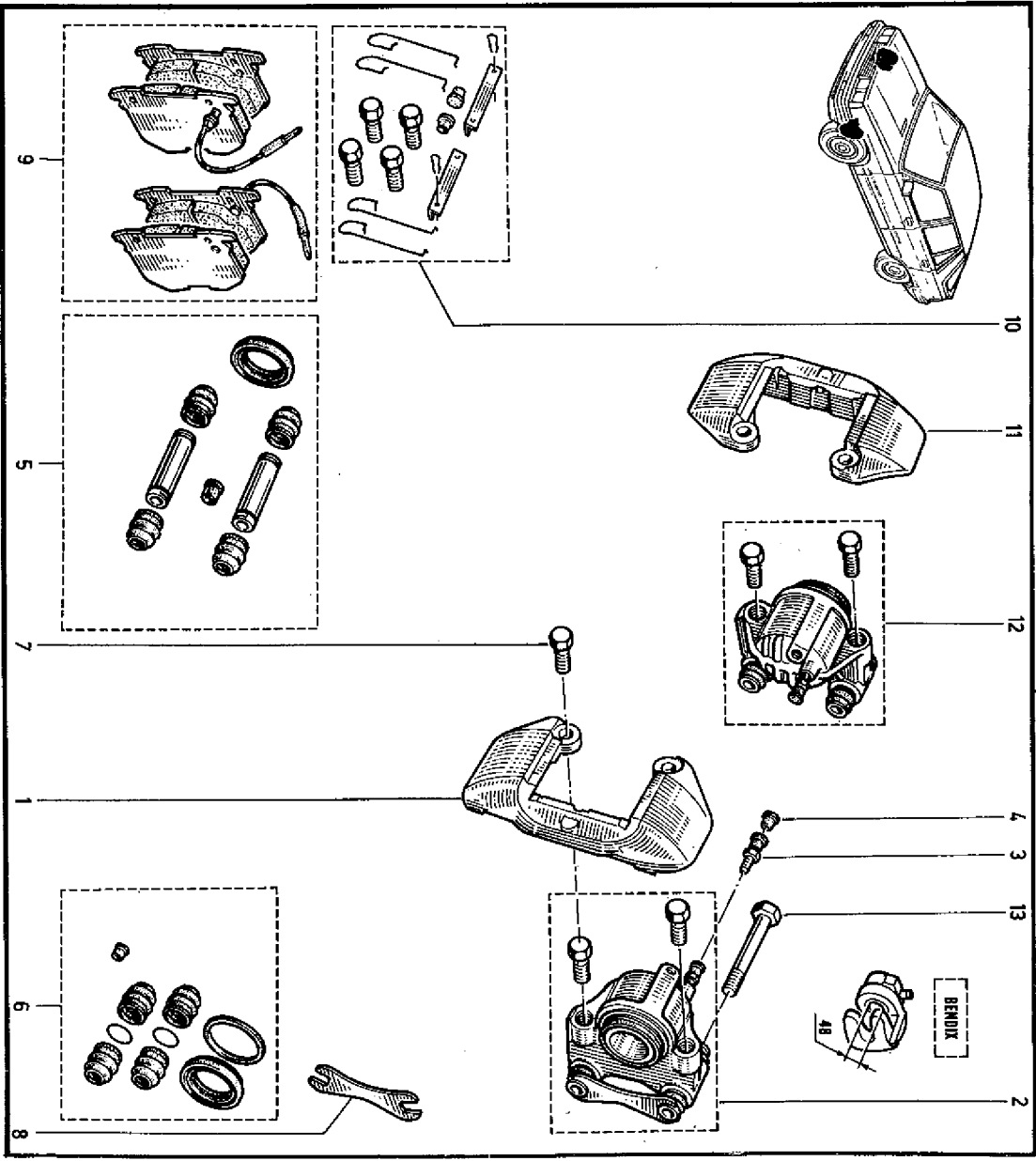

32.30
C.R.1037





32.34
C.R.1037

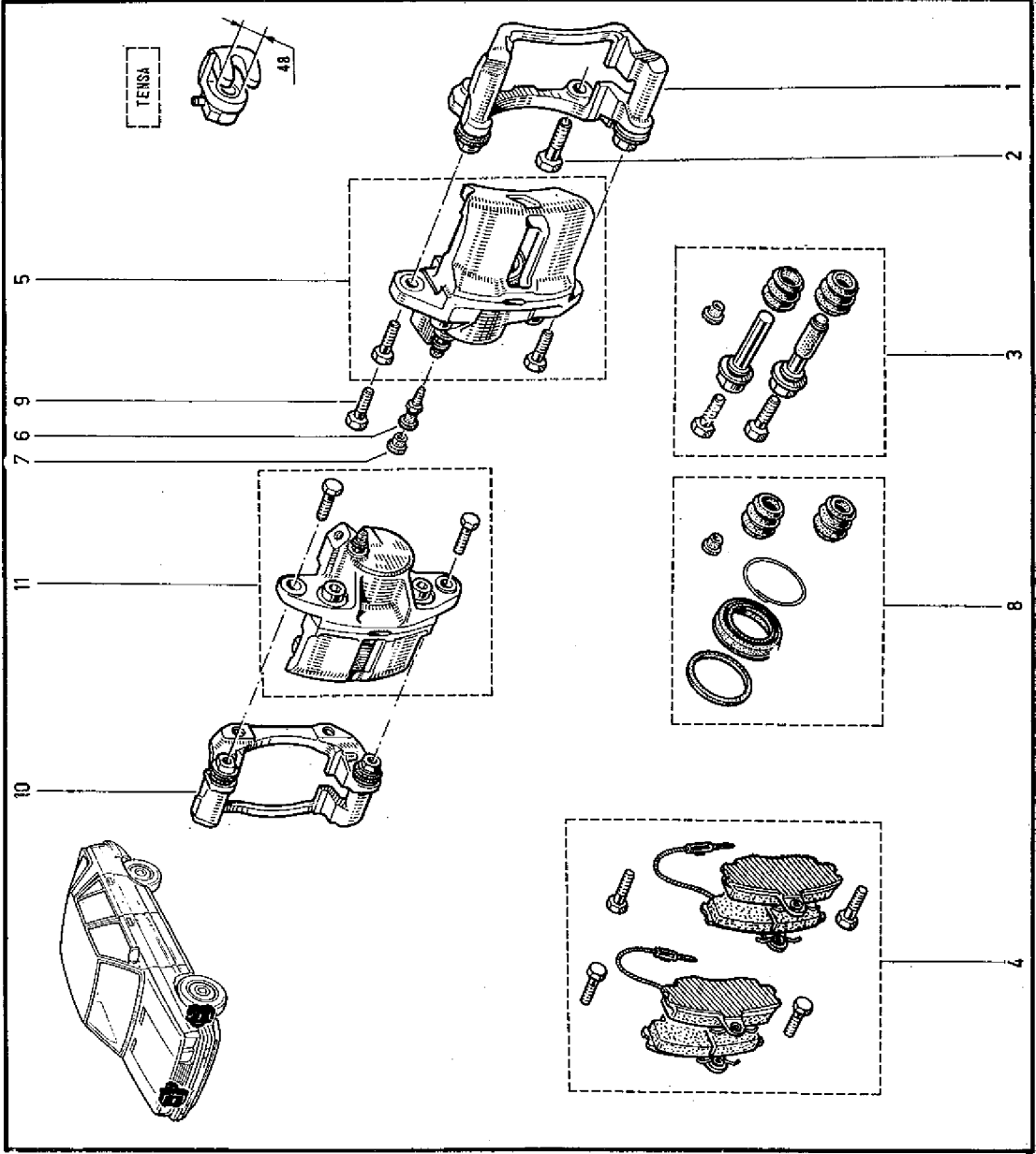

32.34
C.R.1037

- 1 - 77 02 073 855
- 2 - 77 00 698 709
- 3 - 77 02 073 856
- 4 - 77 02 073 857 †
- 5 - 77 02 073 840
- 6 - 77 02 073 858
- 7 - 77 02 073 845
- 8 - 77 01 348 673
- 9 - 77 02 073 859
- 10 - 77 02 073 846
- 11 - 77 02 073 861



32.35
C.R.1037

- 1 - 77 01 027 089
- 2 - 77 00 898 709
- 3 - 77 02 070 221
- 4 - 77 01 201 775
- 77 01 202 285
- 5 - 77 02 089 451
- 6 - 77 02 073 845
- 7 - 77 01 348 673
- 8 - 77 02 073 859
- 9 - 77 02 073 531
- 10 - 77 01 027 100
- 11 - 77 02 089 450

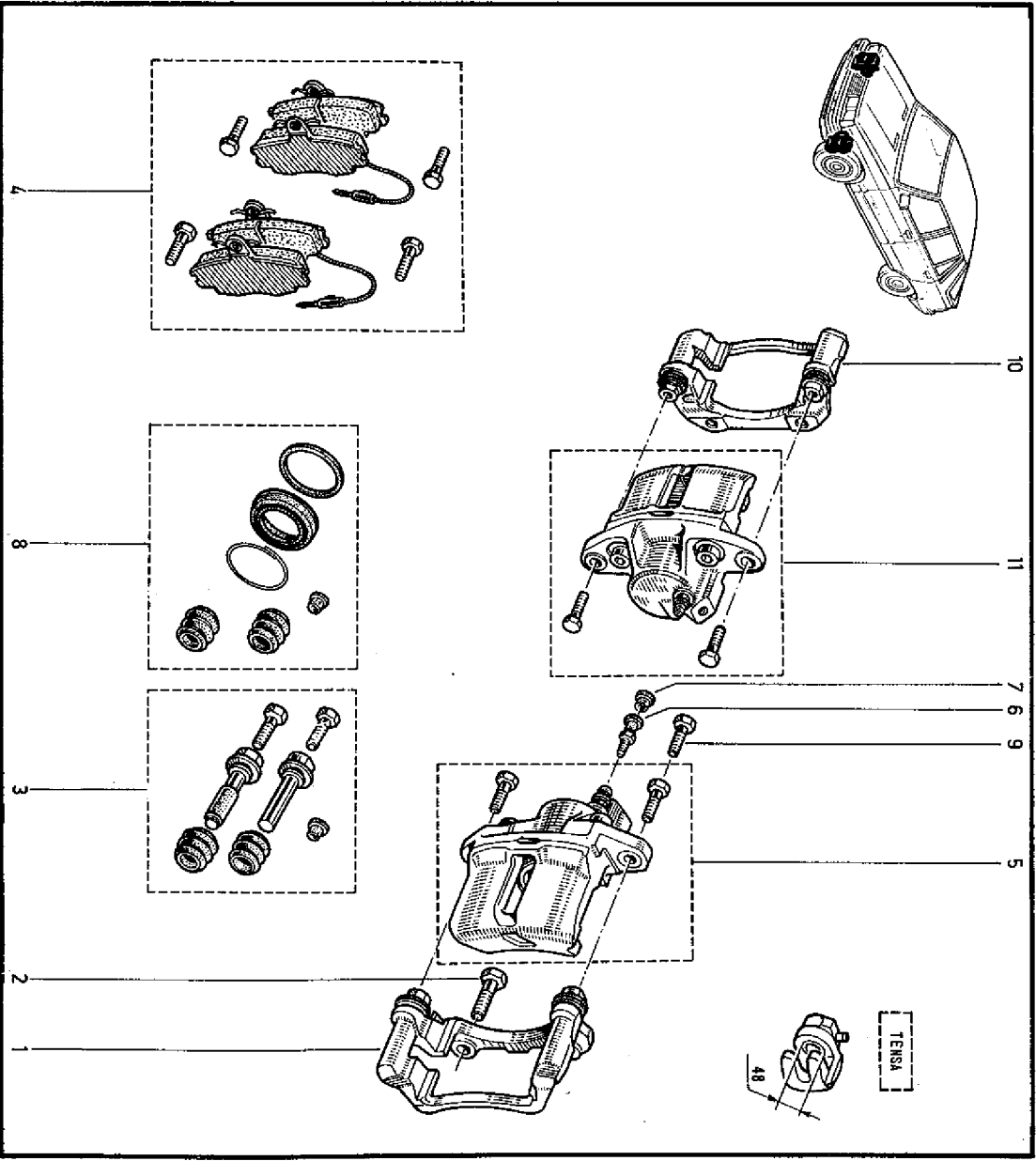

B375

32.35
C.R.1037





33.01
C.R.1037

- 1 - 77 00 696 884 † (a) (b)
- 77 00 765 071 (a) (b) † (21)
- 77 00 778 012 (c) (20)
- 2 - 77 03 101 168
- 3 - 77 03 034 083
- 4 - 79 03 530 077
- 5 - 77 00 688 535
- 6 - 77 03 053 445
- 7 - 77 00 696 882 (a)
- 77 00 765 058 (b) (c)
- 8 - 77 00 687 383
- 9 - 77 04 000 674 (a) (b)
- 10 - 77 00 696 885 † (a) (b)
- 77 00 765 072 (a) (b) † (22)
- 77 00 778 013 (c) (20)
- 11 - 77 00 696 883 (a)
- 77 00 765 059 (b) (c)
- 12 - 77 01 462 512 †
- 77 01 463 723
- 13 - 77 03 034 005
- 14 - 77 00 765 061
- 15 - 77 01 464 321 (c)
- 16 - 77 00 780 173 (c)

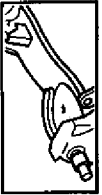

33.01
C.R.1037

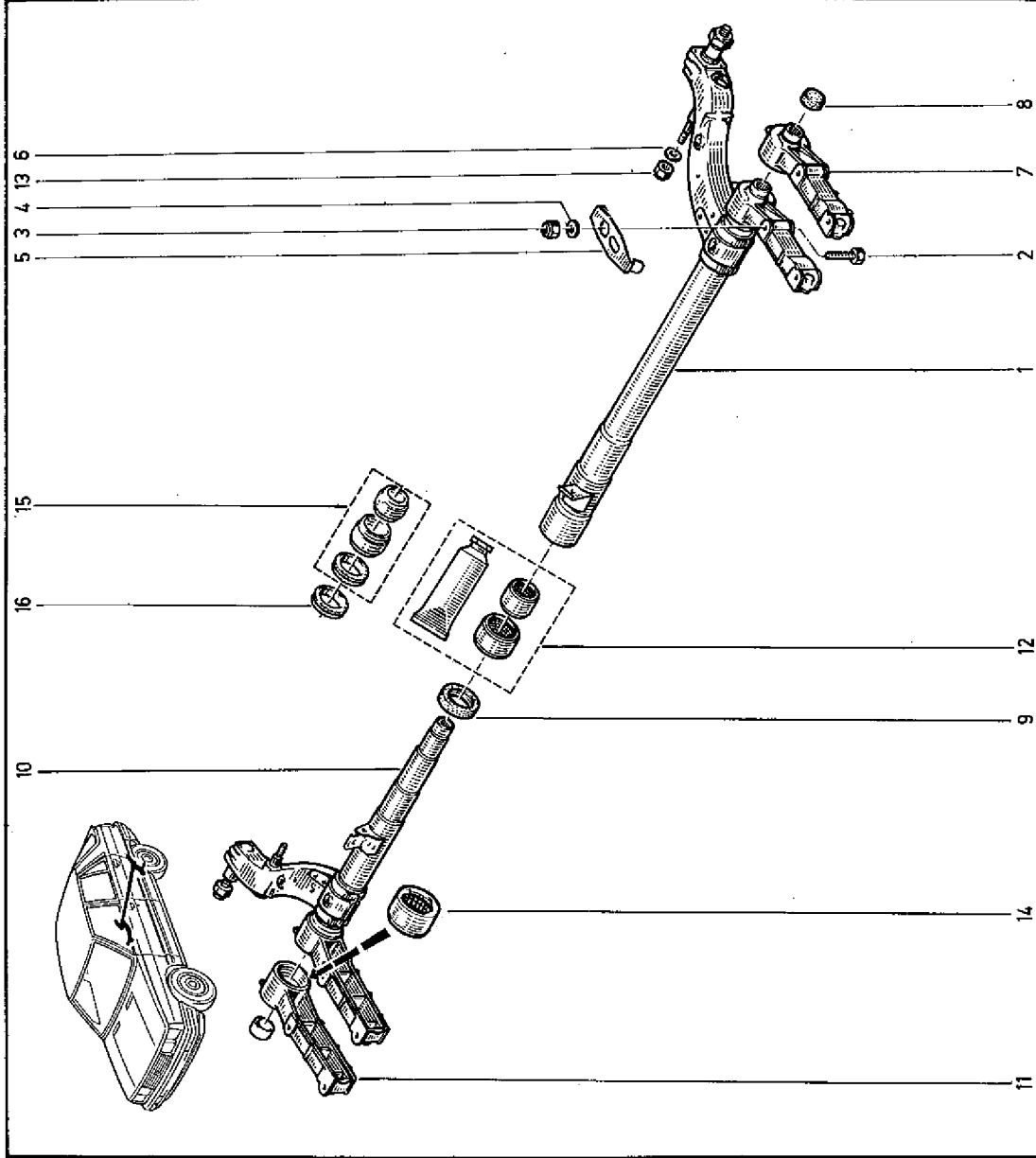

(a)	B372	1	→	n°	02065
	B373	1	→	n°	04501
/					
	B372	1	→	n°	02066
	B373	1	→	n°	04502
(b)	B37E	1	→	n°	02365
	B37G	1	→	n°	04048
	B375	1	→	n°	06684

(c)	B373	1	→	n°	24637
	B37E	1	→	n°	02366
	B37G	1	→	n°	04049
	B375	1	→	n°	00635
	B37I	1	→	n°	

(20) ϕ 77 01 464 321-1
 (21) \square 77 00 778 012-1- ϕ 77 01 463 723-1
 (22) \square 77 00 778 013-1- ϕ 77 01 464 321-1

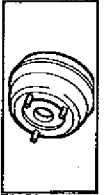

33.40
C.R.1037

- 1 - 77 00 759 095 + (20) (a)
- 2 - 77 03 053 230
- 3 - 77 03 090 253 +
- 77 03 090 313 (21)
- 4 - 77 00 710 507
- 5 - 77 03 066 035
- 6 - 77 03 034 088
- 7 - 77 03 075 105 (a)
- 8 - 77 01 462 217 (a)
- 9 - 77 00 754 393 (b)
- 10 - 77 01 463 523 (b)
- 11 - 77 02 093 841 (b)
- 12 - 77 00 753 876

33.40
C.R.1037

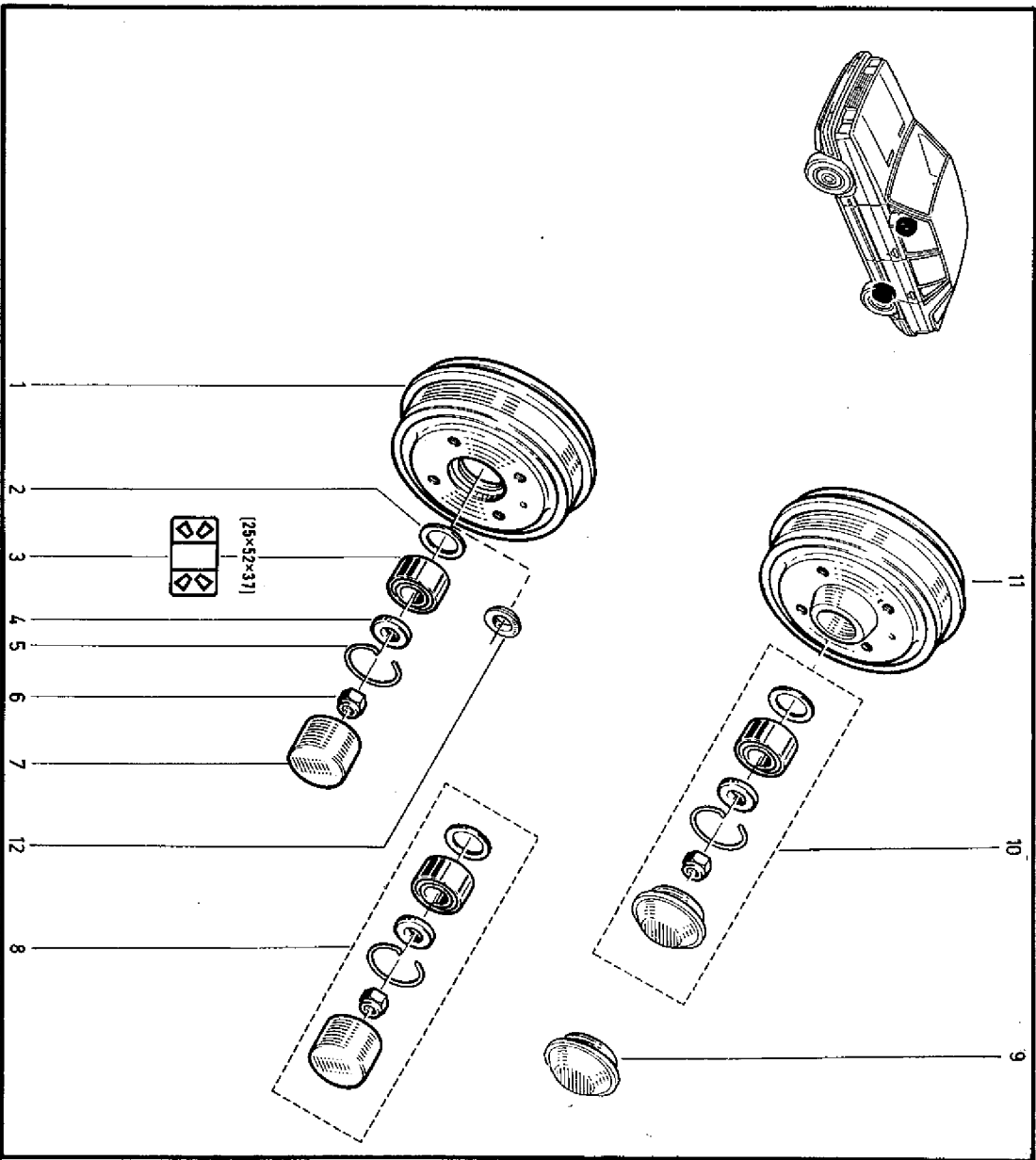

(a)

372	n°	1	⇨	n°
373	n°	1	⇨	n° 23804
B 37E	n°	1	⇨	n° 02073
B 376	n°	1	⇨	n° 03458
375	n°	1	⇨	n°

(b)

373	n°	23805	⇨	n°
B 37E	n°	02074	⇨	n°
B 376	n°	03459	⇨	n°

(20) 77 02 083 841 - 1 - ø 77 00 734 393 - 1
(21) 77 00 753 876 - 1



33.60
C.R.1037

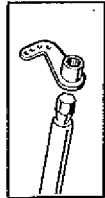
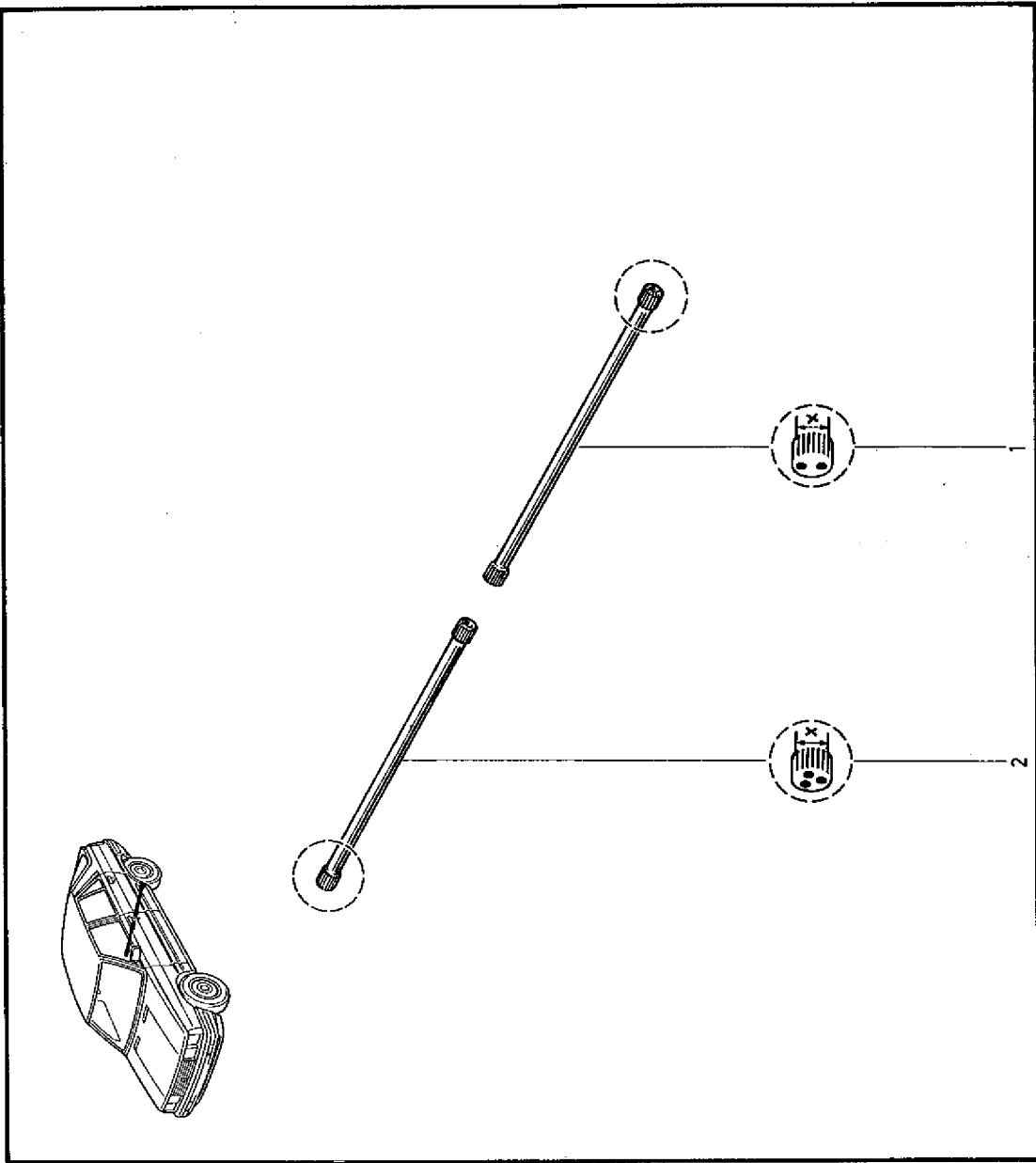

33.60
C.R.1037

- 1 - 77 00 759 872 (x = 19,50)
- 2 - 77 00 759 873 (x = 19,50)

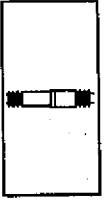

34.01

CR.1037

- 1 - 77 02 073 383
- 2 - 77 02 073 384
- 3 - 77 02 073 699
- 4 - 77 02 073 165
- 5 - 77 00 668 694
- 6 - 77 00 557 850
- 7 - 06 08 490 400

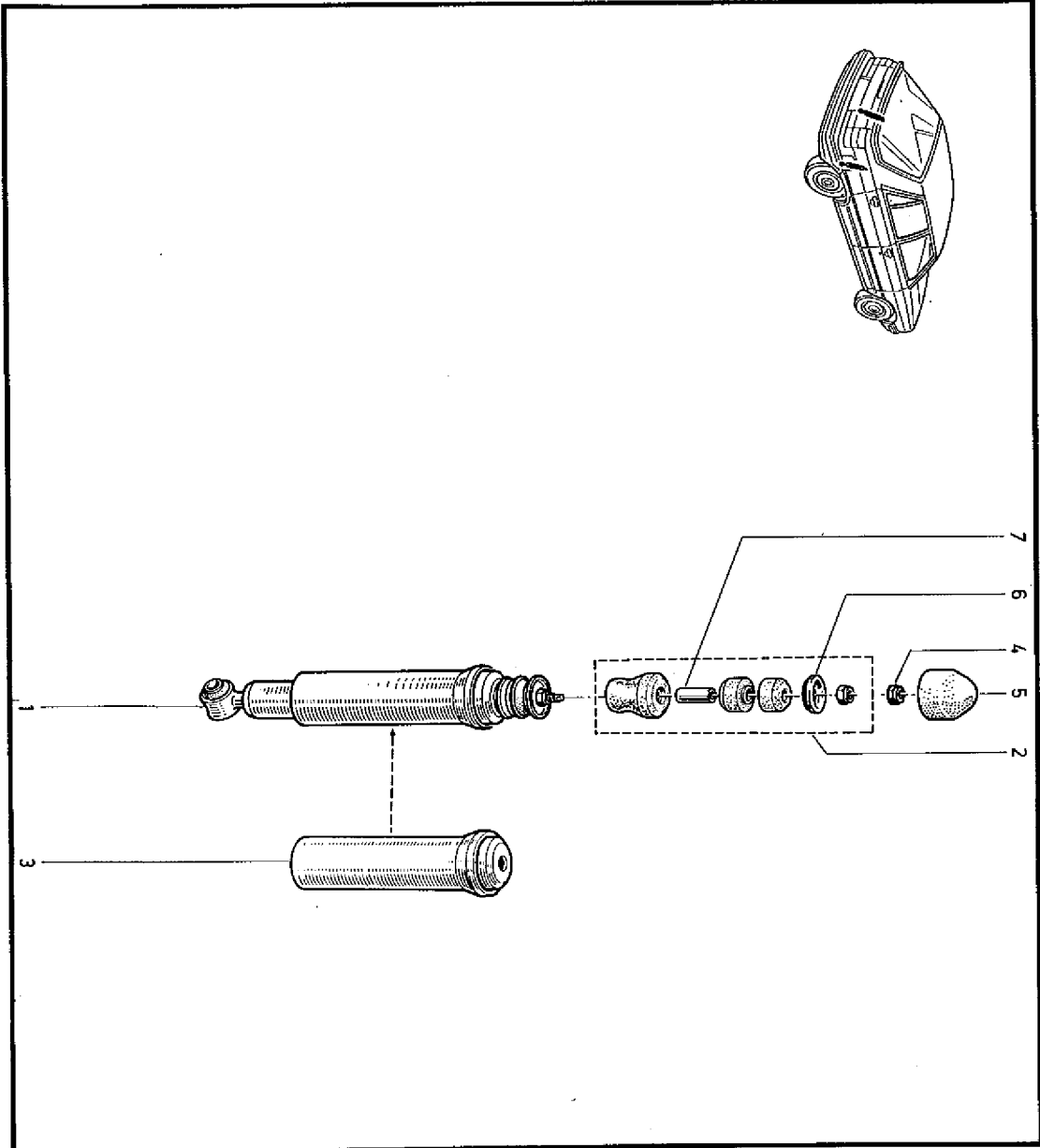

34.01

CR.1037

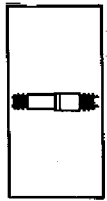

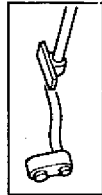

34.10
C.R.1037

- 1 - 77 00 699 009 (x = 15)
- 77 00 699 011 (x = 16) (B-375)
- 2 - 77 03 001 194
- 77 03 101 055
- 3 - 79 03 053 050
- 4 - 77 00 681 260

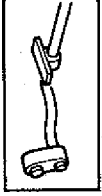

34.10
C.R.1037

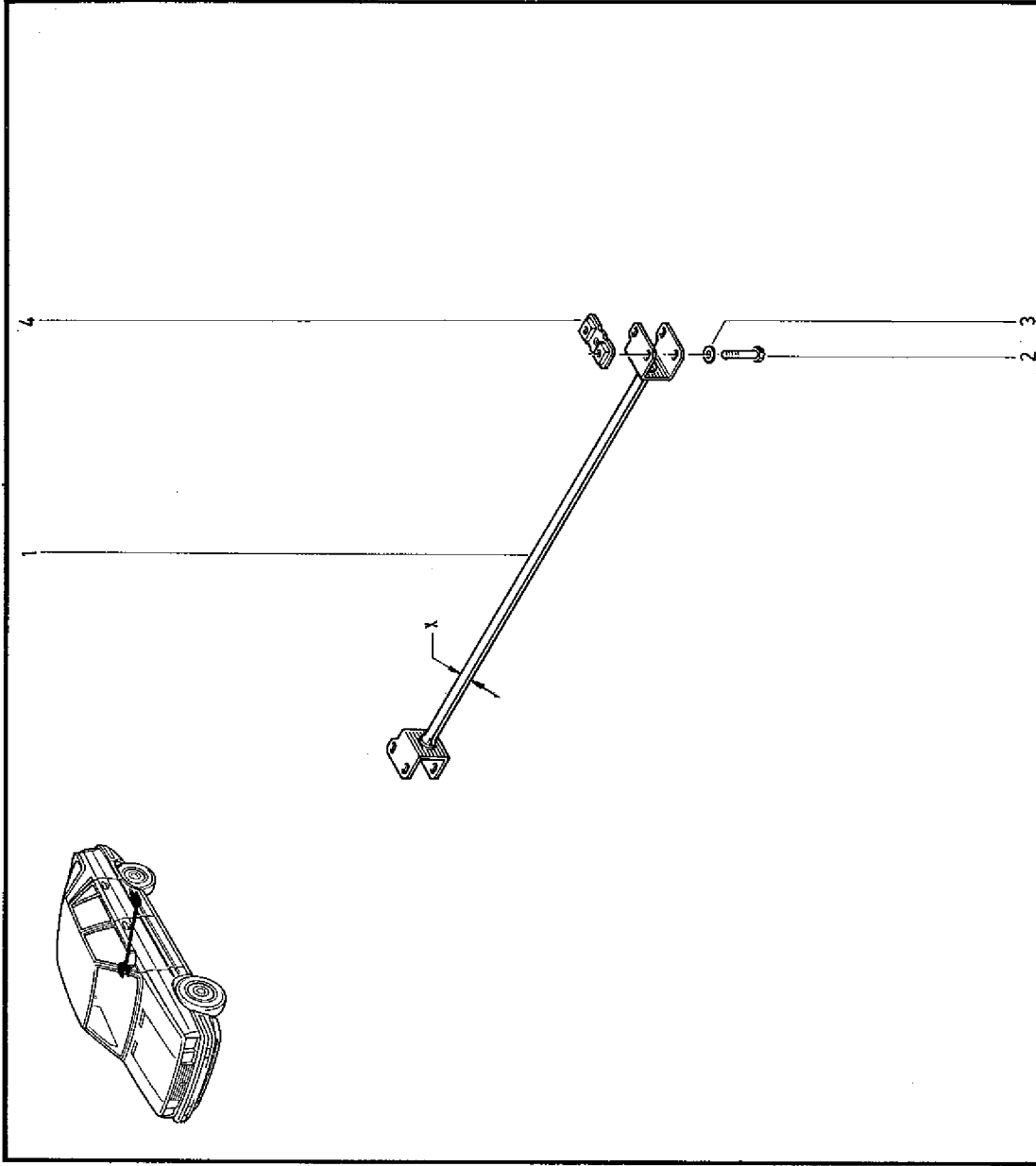



34.30
C.R.1037

- 1 - 77 01 027 367
- 2 - 77 01 349 649
- 3 - 77 01 201 688
- 4 - 77 01 201 689
- 5 - 77 01 201 687
- 6 - 77 01 027 368
- 7 - 77 03 055 011
- 8 - 77 00 676 701

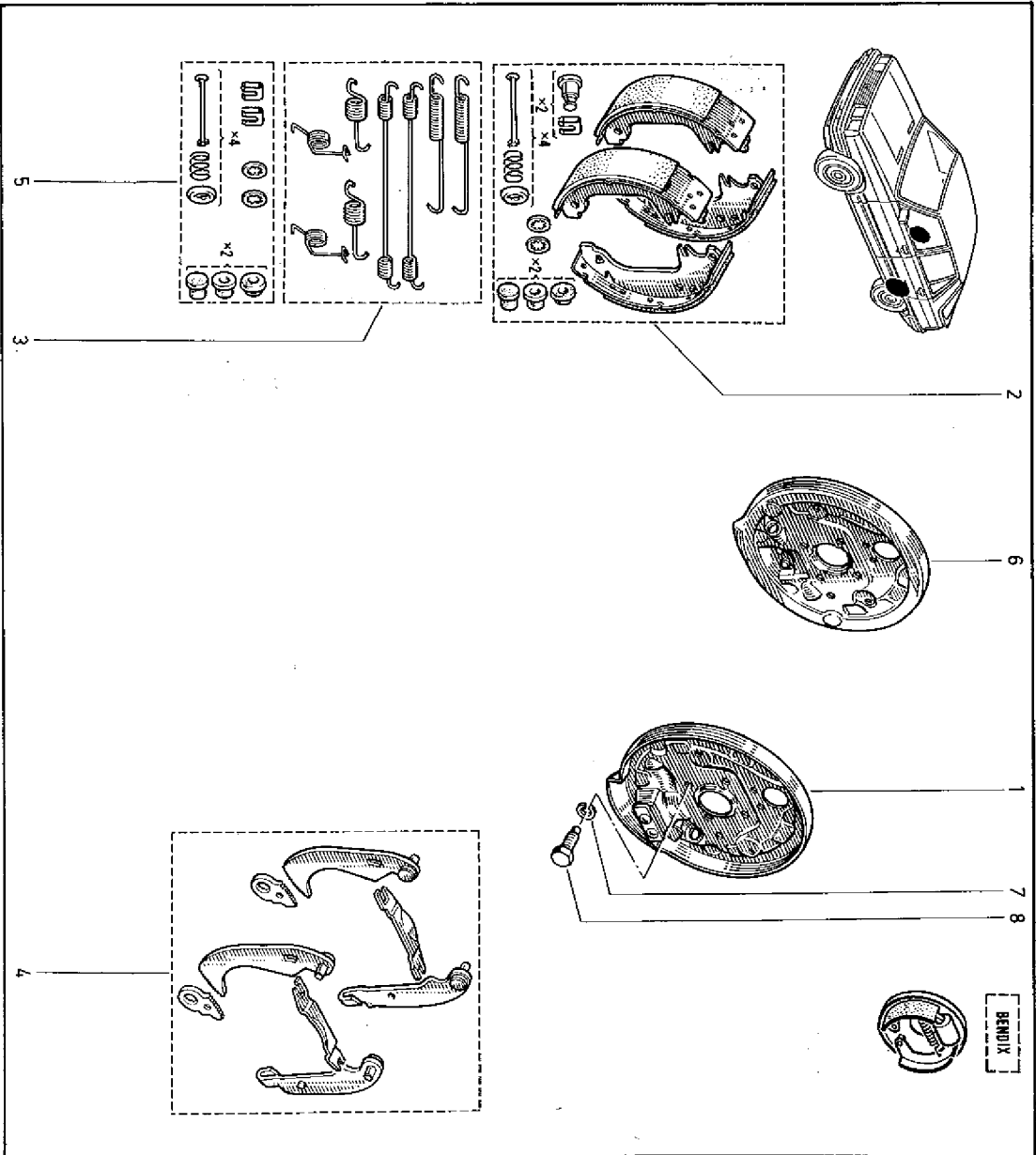

34.30
C.R.1037





34.32
C.R.1037

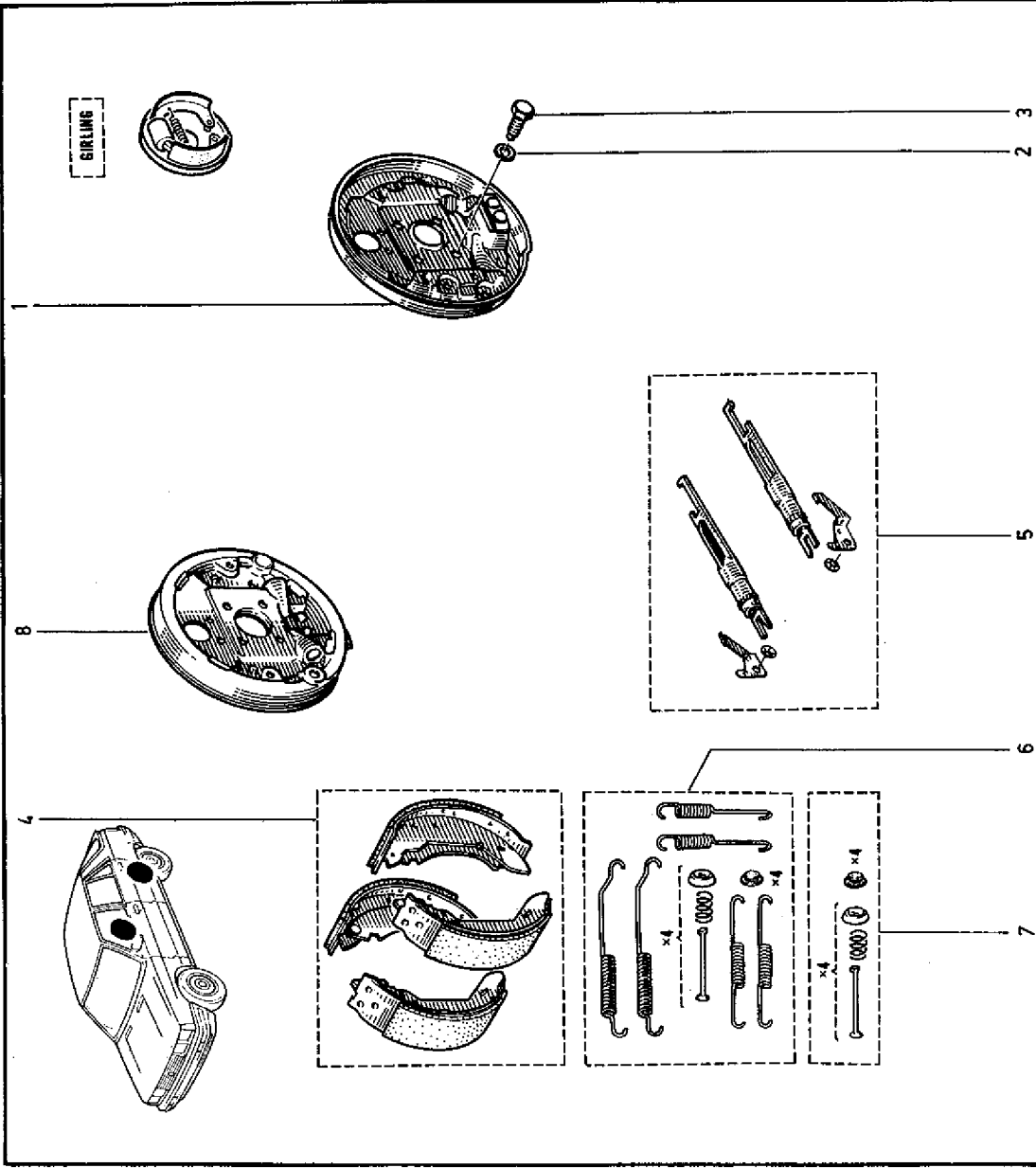

34.32
C.R.1037

- 1 - 77 01 028 247
- 2 - 77 03 055 011
- 3 - 77 00 676 701
- 4 - 77 01 349 646
- 5 - 77 01 201 825
- 6 - 77 01 201 823
- 7 - 77 01 201 824
- 8 - 77 01 028 248



34.40
C.R.1037

- 1 - 77 01 349 123 (A)
- 77 01 024 265 (B)
- 2 - 77 01 349 122 (A)
- 77 01 024 266 (B)
- 3 - 77 01 348 674
- 4 - 77 01 348 673
- 5 - 77 03 001 118
- 6 - 79 03 056 008
- 7 - 77 01 201 680 (A)
- 77 01 201 353 (B)

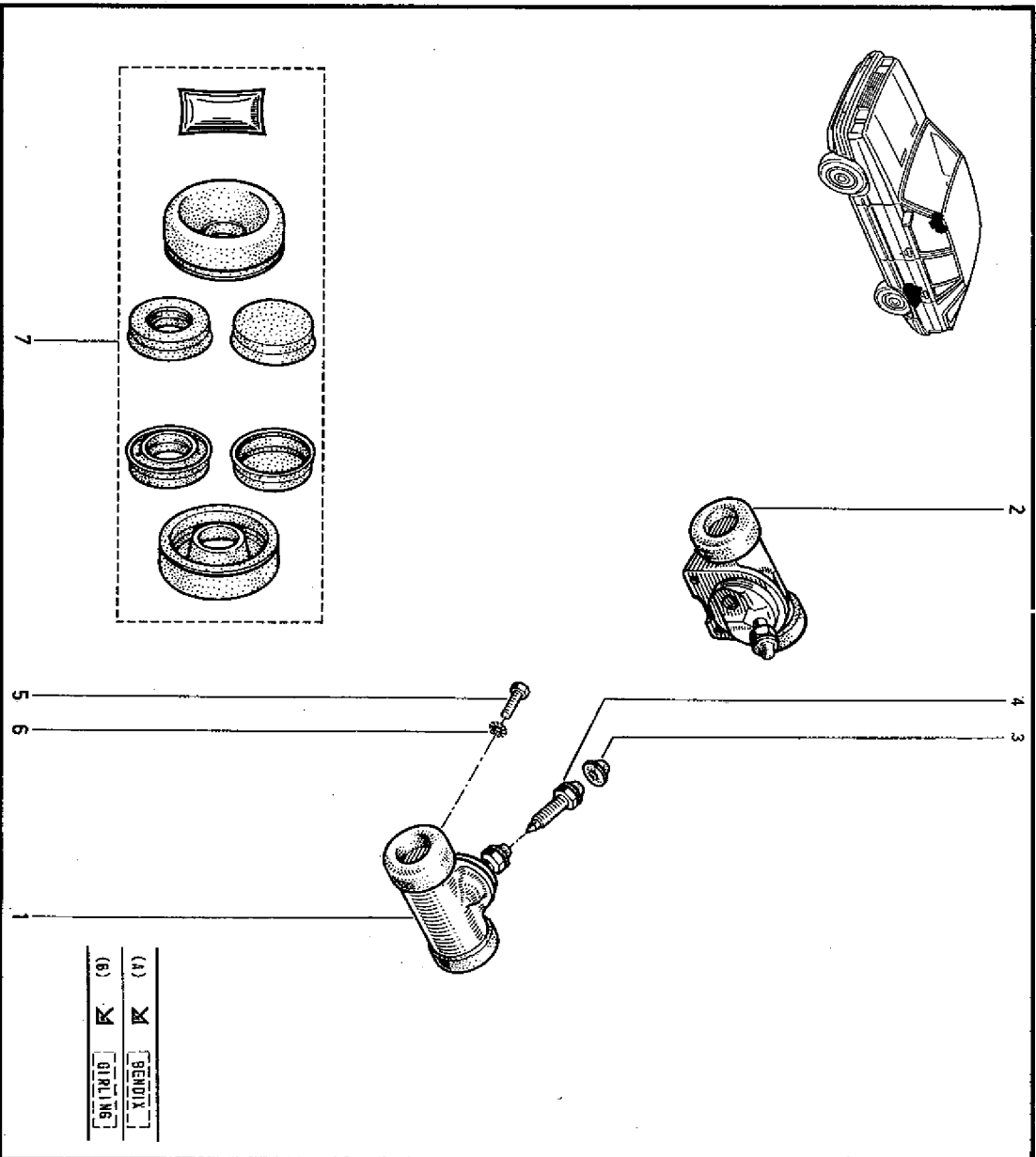

34.40
C.R.1037



(A)	<input checked="" type="checkbox"/>	BENDIX
(B)	<input checked="" type="checkbox"/>	GIRLING



35.01
C.R.1037

- 1 - 77 04 001 213 (A) (e)
- 77 02 093 837 (A) (g)
- 2 - 77 00 630 267
- 3 - 77 00 694 619 (b)
- 4 - 77 00 686 912
- 5 - 77 00 694 618 (b) (K)
- 6 - 77 00 715 532 (c) (f)
- 7 - 77 00 715 371 (c) (f)
- 8 - 77 00 643 943
- 9 - 77 00 636 358
- 77 02 094 184
- 10 - 77 00 636 359
- 77 02 094 185
- 11 - 77 00 636 360
- 77 02 094 186
- 12 - 77 00 636 361
- 77 02 094 187
- 13 - 77 00 636 362
- 77 02 094 189
- 14 - 77 00 636 363
- 77 02 094 191
- 15 - 77 00 636 364
- 77 02 094 193
- 16 - 77 00 717 876 (d)
- 17 - 77 00 696 936 (d)
- 18 - 77 04 001 779 (e)
- 77 02 093 836 (f)
- 19 - 77 00 668 275 (e) (f)
- 20 - 77 00 663 286 (e) (f)
- 21 - 77 00 735 123 (f) †
- 77 00 731 015 (h)
- 22 - 77 00 731 524 (h)
- 77 00 735 125 (j) †
- 23 - 77 02 206 270 (f)
- 77 00 732 841 (j)
- 24 - 77 00 735 177 (L) †
- 77 02 206 269 (L)

B/37G	1	→	n° 03458
(a) / B-372	1	→	n°
B/373	1	→	n° 23804
(b) / B-372	1	→	n°
(c) / B-373	1	→	n° 06156
(d) / B-373	1	→	n° 16883



35.01
C.R.1037

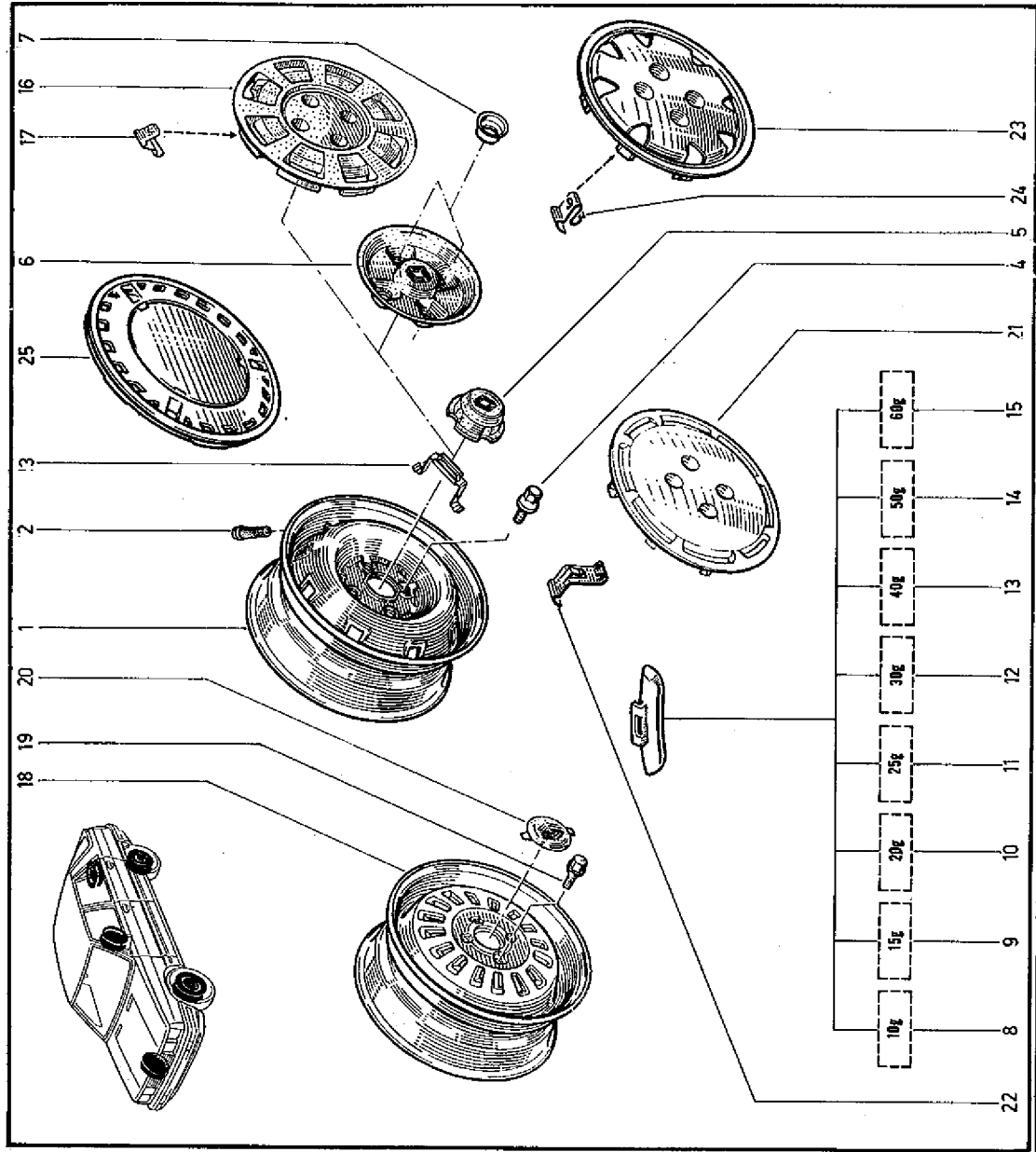

(e) / B-37E	1	→	n° 2073
B-375	1	→	n°
(f) / B-37E	1	→	n°
(g) / B-373	1	→	n° 23805
B-376	1	→	n° 03459
(h) / B-373	1	→	n° 16884
(i) / B-37G	1	→	n° 06620
(j) / B-373	1	→	n° 30734
(k) / B-37G	1	→	n° 6621
(l) / B-371	1	→	n°

10g	8	→	
15g	9	→	
20g	10	→	
25g	11	→	
30g	12	→	
40g	13	→	
50g	14	→	
60g	15	→	

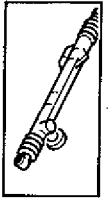

36.01
C.R.1037

- 1 - 77 01 462 168 (a) †
- 77 00 707 473 (a)
- 2 - 77 00 770 996 (b) †
- 77 00 752 093 (b) †
- 77 02 093 736 (b)
- 77 02 093 663 (b) †
- 3 - 77 02 097 153 (c)

36.01
C.R.1037

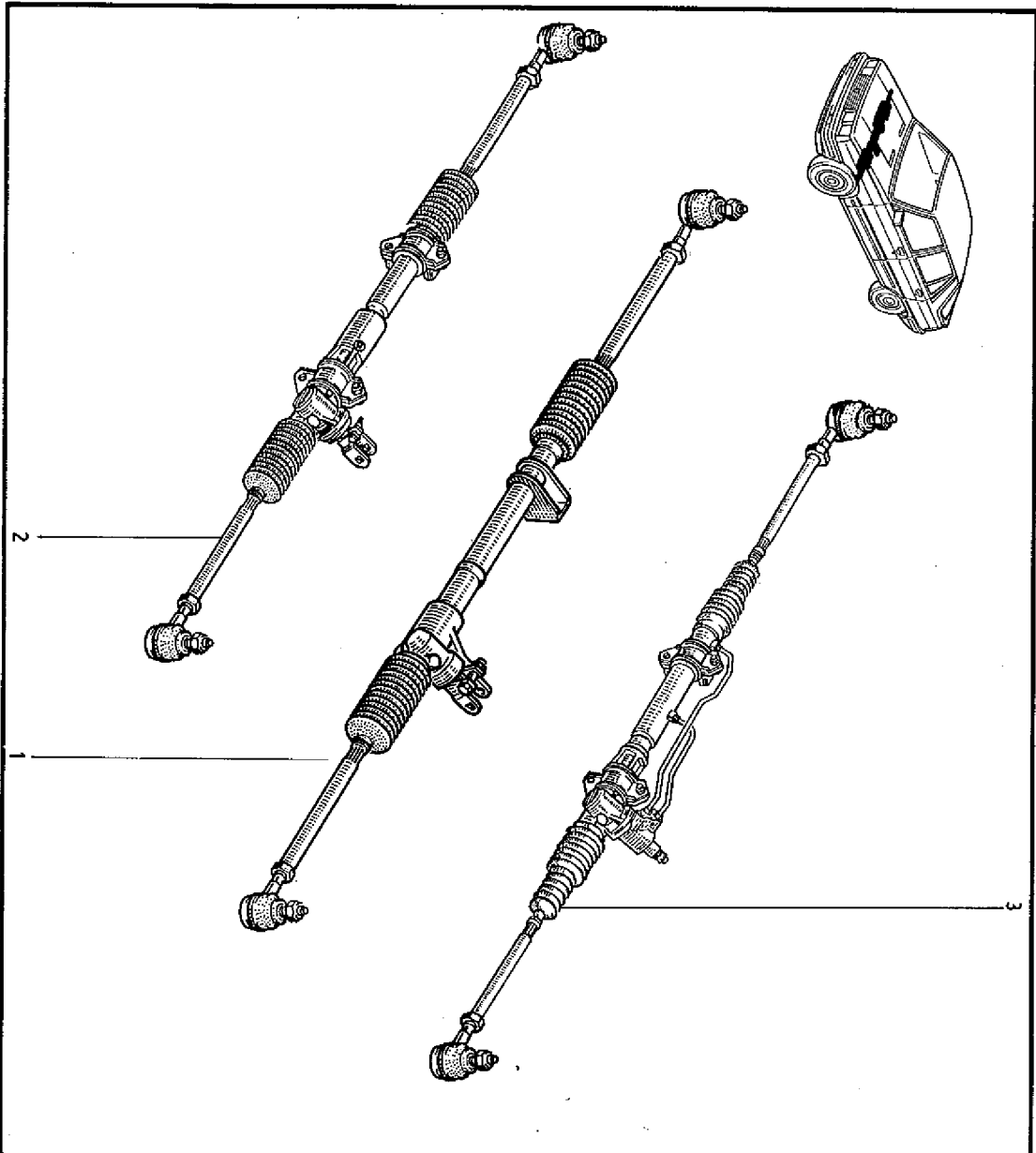

(a)	B372	1	⇨	n°MO28609	(b) / B375	1	⇨	n°
	B373	1	⇨	n°22186	B373	1	⇨	n°22187
	B37E	1	⇨	n°01292	B37E	1	⇨	n°01293
	B37G	1	⇨	n°02233	B37G	1	⇨	n°02239



36.10
C.R. 1037

- 1 - 77 04 000 926
- 2 - 77 00 679 319 (a)
- 3 - 77 00 773 311 (b)
- 4 - 77 05 015 113 (a)
- 5 - 77 05 015 214 (b)
- 6 - 77 03 065 119 (a)
- 7 - 77 03 065 185 (b)
- 8 - 77 00 679 315 (a)
- 9 - 77 00 772 878 (b)
- 10 - 77 00 678 649 (a)
- 11 - 77 00 764 267 (a)
- 12 - 77 03 001 162 (c)
- 13 - 77 05 001 152
- 14 - 77 03 034 019
- 15 - 79 03 032 018
- 16 - 77 03 053 142†
- 17 - 79 03 053 050
- 18 - 77 03 055 011
- 19 - 77 00 678 323
- 20 - 77 00 766 422
- 21 - 77 03 001 440
- 22 - 77 03 034 027
- 23 - 77 03 085 024
- 24 - 6035709
- 25 - 77 01 461 412 (c)
- 26 - 77 02 093 667 (c)
- 27 - 77 02 093 663 (d)
- 28 - 77 02 762 859 (d)
- 29 - 77 03 101 199 (c)
- 30 - 77 00 653 459 (c)
- 31 - 77 00 774 566 (c)
- 32 - 77 03 101 197 (c)
- 33 - 77 03 053 431 (c)
- 34 - 77 02 093 666 (c)
- 35 - 77 00 762 858 (d)
- 36 - 77 02 093 668 (d)
- 37 - 77 00 665 249 (c)
- 38 - 77 03 065 087 (c)
- 39 - 77 00 659 275 (c)
- 40 - 77 00 662 674 (c)
- 41 - 77 02 093 670 (c)
- 42 - 77 02 093 672 (d)
- 43 - 77 00 762 856 (d)
- 44 - 77 00 662 571 (c)
- 45 - 77 00 661 616 (c)
- 46 - 77 02 093 671 (c)
- 47 - 77 00 762 857 (d)
- 48 - 77 02 093 673 (d)
- 49 - 77 00 680 852 (c)
- 50 - 77 03 053 674 (a)
- 51 - 77 03 053 164 (a)
- 52 - 77 03 058 117 (a)

36.10
C.R. 1037

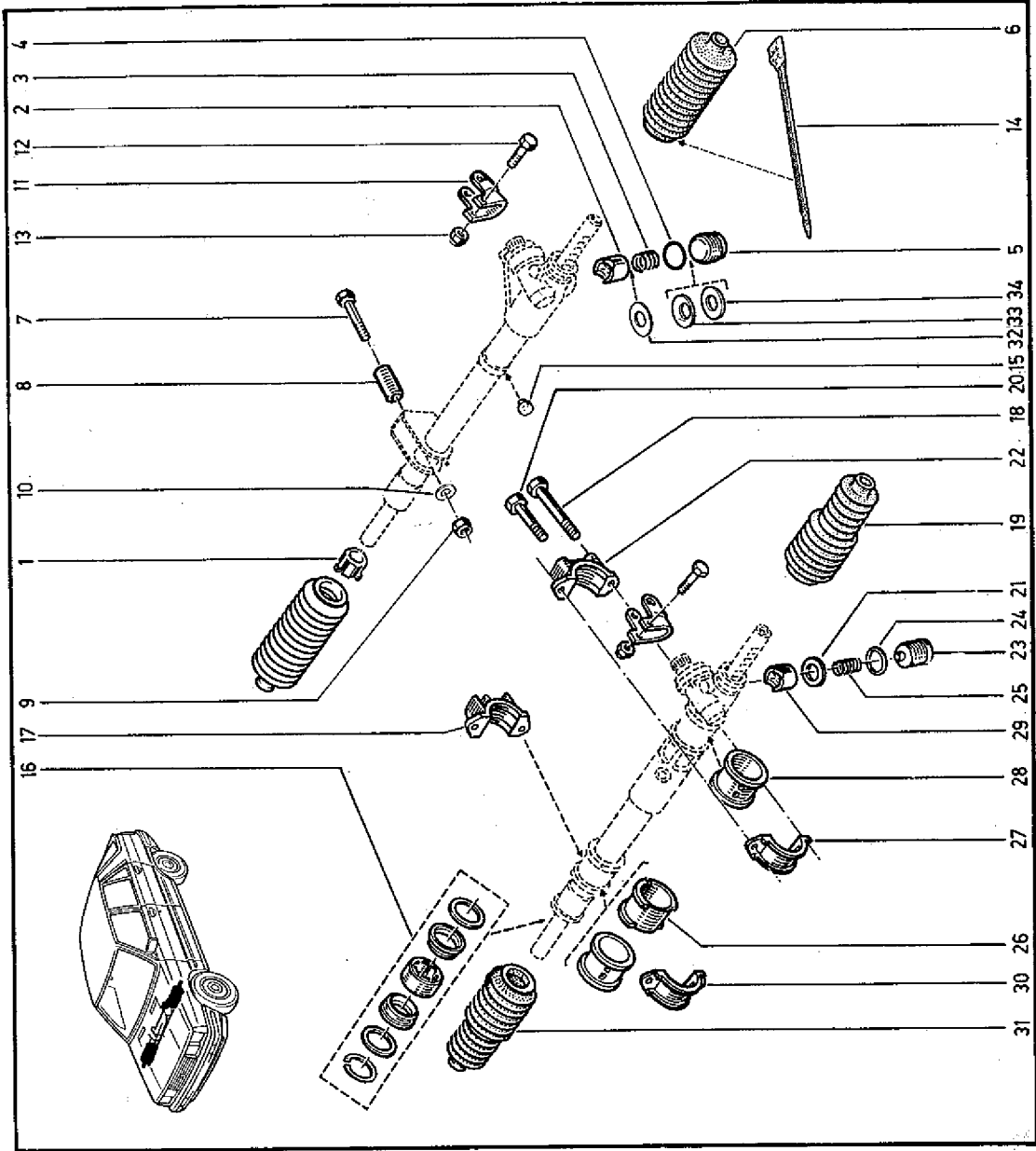
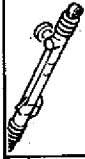

(a)	B372	n°	□	n°MOD 8606	B373	n°	□	n° 22187	n°	□	n°	...
	B373	n°	□	n°MOD 8606	B37G	n°	□	n° 02238	n°	□	n°	...
(b)	B372	MOD 8607	□	n°MOD 8609	B37E	n°	□	n° 01293	n°	□	n°	...
	B373	MOD 8607	□	n°MOD 8609	B37E	n°	□	n° 01293	n°	□	n°	...
	B37G	n°	□	n° 02238	B37E	n°	□	n° 01282	n°	□	n°	...
	B37E	n°	□	n° 01282	B37E	n°	□	n° 01282	n°	□	n°	...



36.12
C.R.1037



36.12
C.R.1037



- 1 - 77 00 757 947
- 2 - 77 03 001 693
- 3 - 79 03 053 043
- 4 - 77 03 034 037
- 5 - 77 03 055 011
- 6 - 77 03 001 162
- 7 - 77 01 201 828
- 8 - 79 03 053 043
- 9 - 77 03 101 199
- 10 - 77 05 001 052
- 11 - 79 03 053 050
- 12 - 77 03 034 098
- 13 - 77 03 101 120
- 14 - 77 00 662 571
- 15 - 77 00 762 856
- 16 - 77 00 762 857
- 17 - 77 00 662 674
- 18 - 77 00 706 007
- 19 - 77 00 760 467
- 20 - 77 00 760 465
- 21 - 77 00 717 694
- 22 - 77 03 053 431
- 23 - 77 00 659 275
- 24 - 77 03 065 087
- 25 - 77 00 665 249
- 26 - 38 01 845 000 (↔ 5000)
- 27 - 77 03 055 013
- 28 - 77 02 094 429

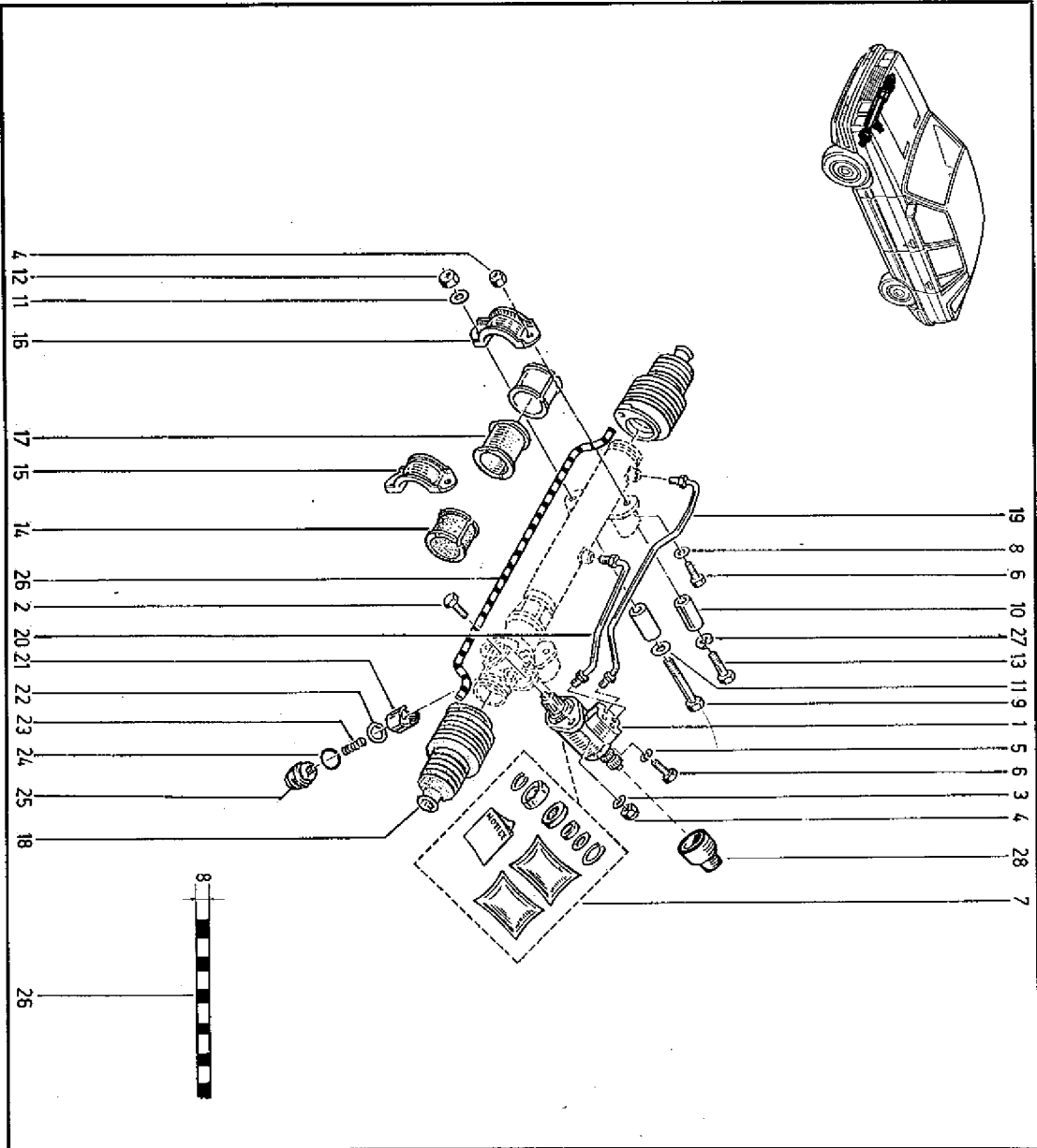



36.30
C.R.1037

- 1 - 77 00 681 400
- 2 - 77 00 695 677
- 3 - 79 03 032 074
- 4 - 77 00 678 597
- 5 - 77 03 066 234
- 6 - 77 03 019 103
- 7 - 79 03 056 014
- 8 - 77 03 035 003
- 9 - 77 01 349 285
- 10 - 77 00 563 649
- 11 - 77 00 687 428 (a)
- 12 - 77 03 001 440
- 13 - 77 03 034 027
- 14 - 77 00 691 031
- 15 - 77 02 093 869
- 16 - 77 03 001 670
- 17 - 77 03 101 207
- 18 - 77 00 759 418
- 19 - 77 00 707 351
- 20 - 50 03 030 009
- 21 - 77 03 080 293
- 22 - 77 00 710 098 (b) (c)
- 23 - 77 00 769 465 (a) (170) †
- 24 - 77 00 776 348 (b) (c)
- 25 - 77 00 769 862 (a) (170) †
- 26 - 77 03 077 080 (a)
- 27 - 77 03 080 059 (b) (c)
- 28 - 77 03 084 016 (b) (c)
- 29 - 77 01 464 006 (a)



36.30
C.R.1037

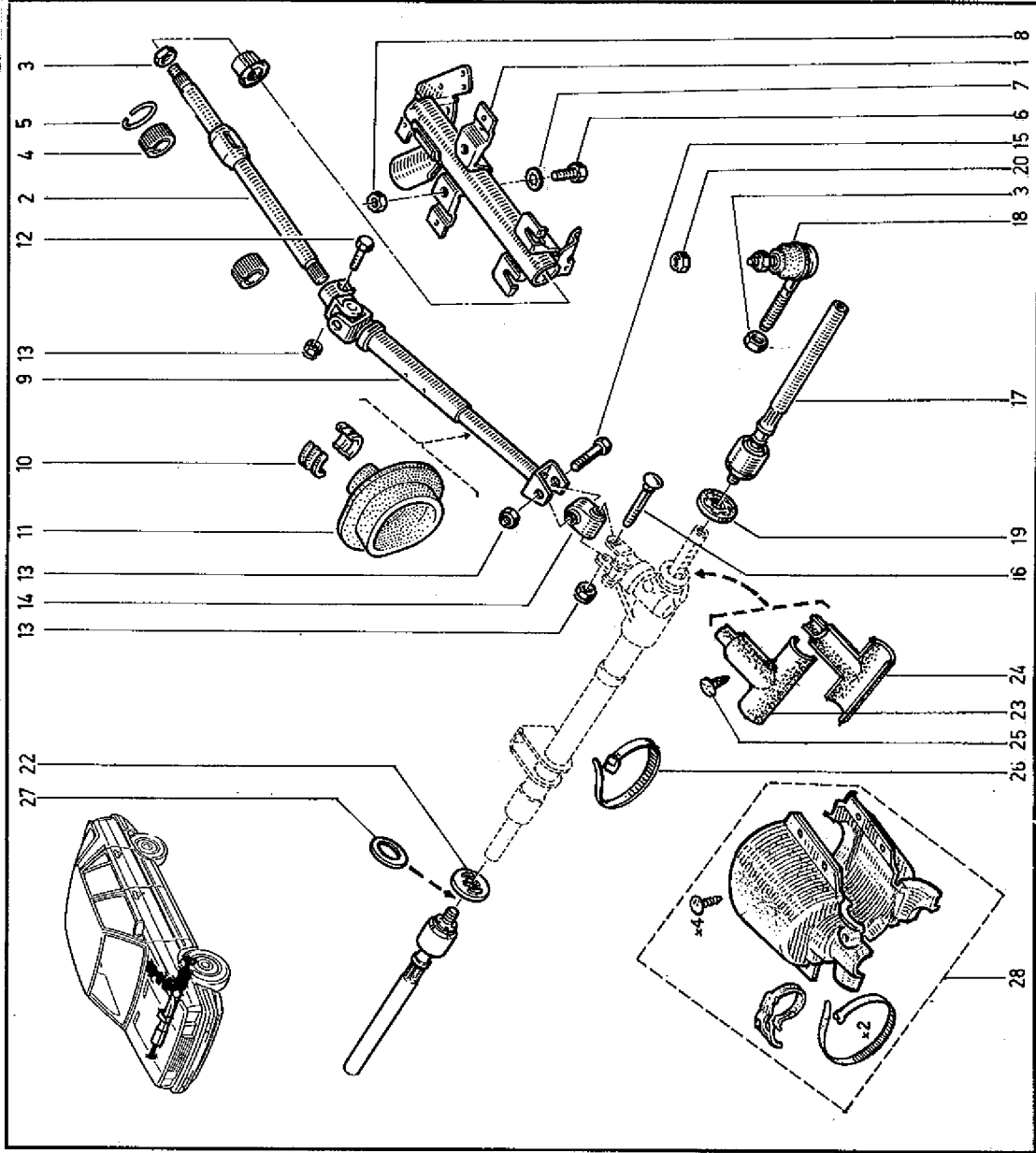

(a)	B372	n°	□	n°MOQ8609		□	n°
	B373	n°	□	n°22186		□	n°
	B37E	n°	□	n°01292	(c)	□	n°
	B37G	n°	□	n°02238		□	n°
(b)	B375	n°	□	n°		□	n°
	B373	n°	□	n°22187		□	n°
(c)	B37E	n°	□	n°01293		□	n°
	B37G	n°	□	n°02239		□	n°

(170) □ 77 01 464 006 1



36.40
C.R.1037

- 1 - 77 04 001 077
- 2 - 77 04 002 034 (a)
- 3 - 77 04 002 037 (a)
- 4 - 77 02 085 343 (B-375) (b)
- 5 - 77 00 757 408 (B-375)
- 6 - 77 04 001 815 (b)

36.40
C.R.1037

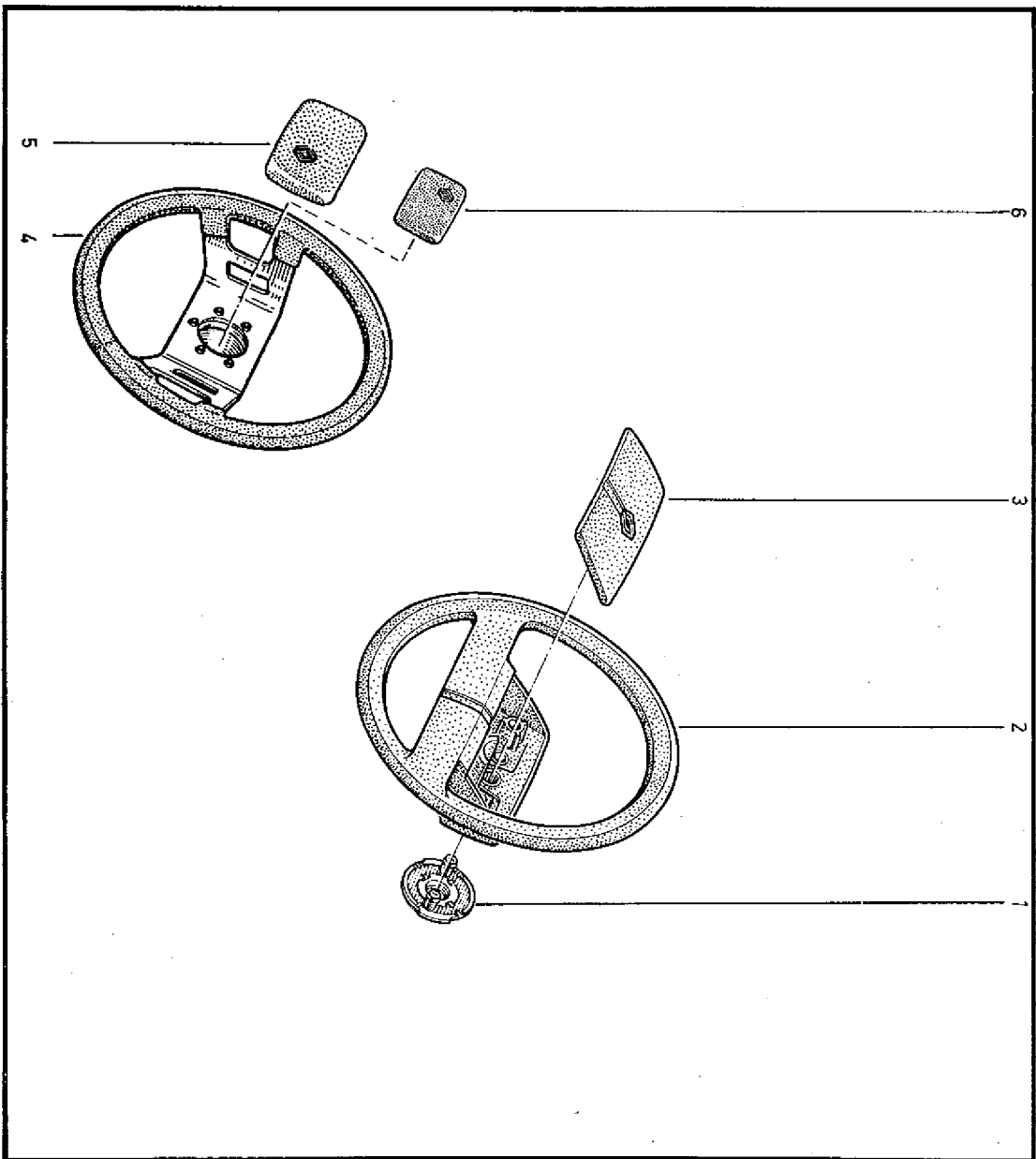

	B372	B372	n°	1	→	n°
	B373	B373	n°	1	→	n°
(a)	B376	B376	n°	1	→	n°
	B37E	B37E	n°	1	→	n°



37.01
C.R.1037

- 1 - 77 00 693 847
- 2 - 77 05 035 125
- 3 - 77 03 066 297
- 4 - 77 00 679 618
- 5 - 77 00 681 144
- 6 - 77 00 680 837
- 7 - 77 00 679 919
- 8 - 77 00 679 621
- 9 - 77 00 679 620
- 10 - 77 00 701 597
- 11 - 77 03 057 021
- 12 - 77 03 053 105
- 13 - 77 03 066 257
- 14 - 77 00 679 614
- 15 - 77 05 016 017
- 16 - 77 00 682 392
- 17 - 77 00 680 836
- 18 - 77 00 679 617
- 19 - 77 00 694 264
- 20 - 77 03 035 003
- 21 - 77 00 707 382
- 22 - 77 02 093 552

37.01
C.R.1037

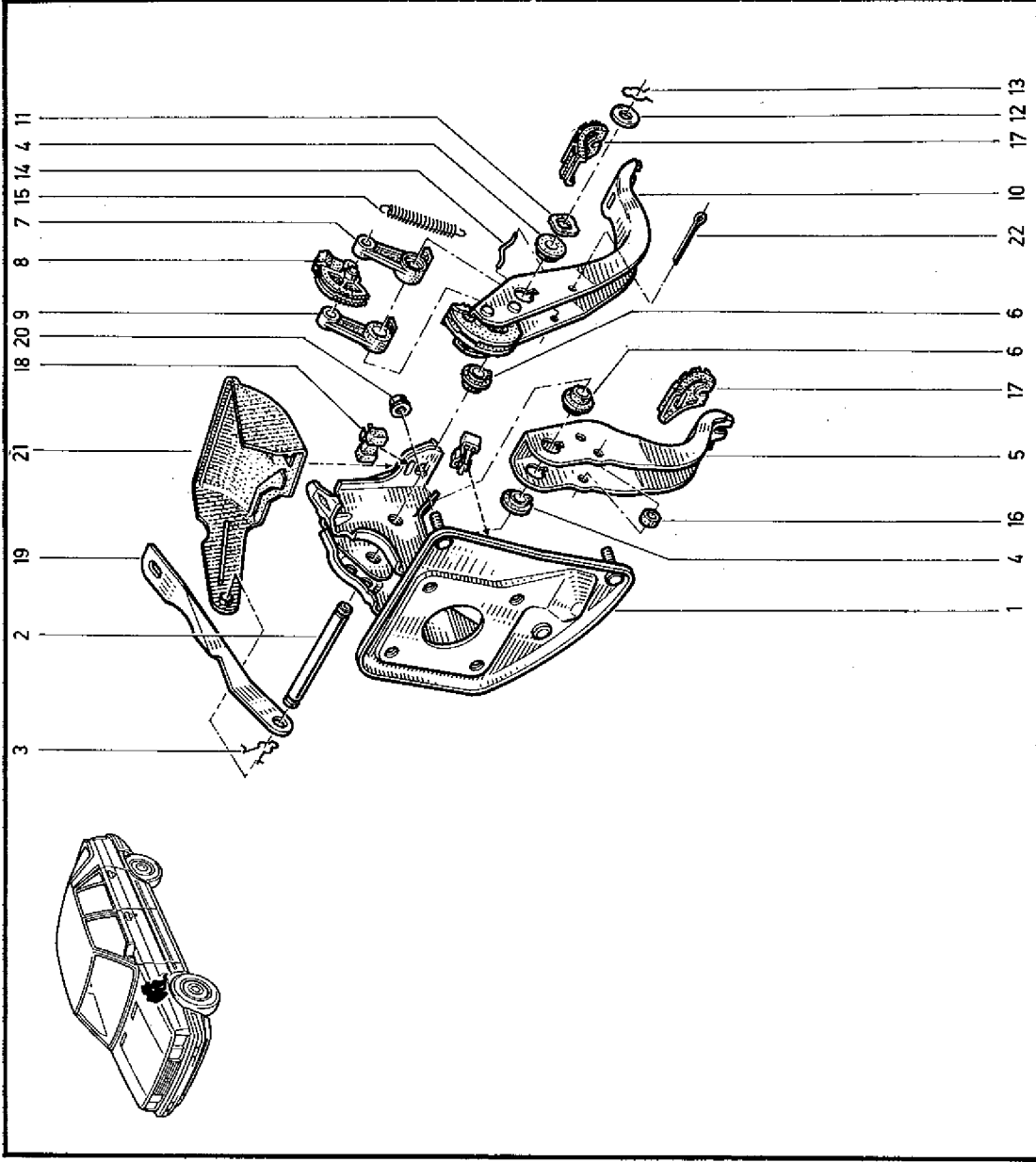

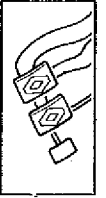

- 1 - 77 02 085 088
- 77 04 001 506
- 2 - 77 03 079 146
- 3 - 77 03 079 116

37.20
C.R.1037

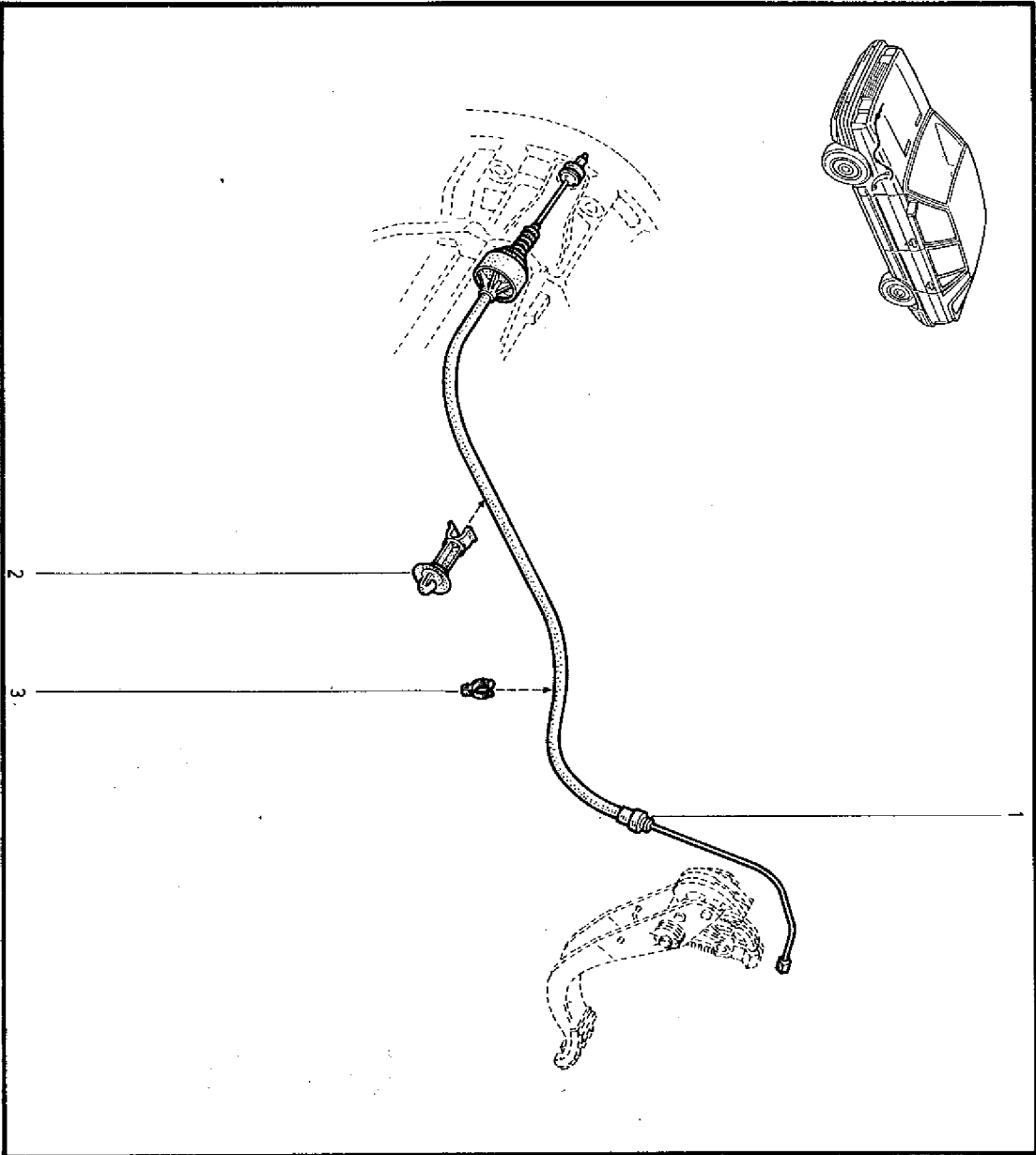

37.20
C.R.1037

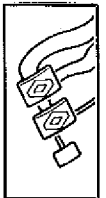

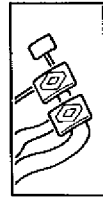

37.30
C.R.1037

- 1 - 77 00 686 028
- 77 00 759 386 (B-375)
- 2 - 77 04 001 520
- 77 00 768 061
- 3 - 77 03 001 956
- 4 - 77 00 632 139
- 77 00 757 268 (B-375)
- 5 - 77 04 001 509 (a)
- 77 04 001 510 (b)
- 77 00 762 380 (B-375)

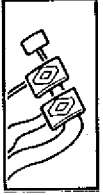

37.30
C.R.1037

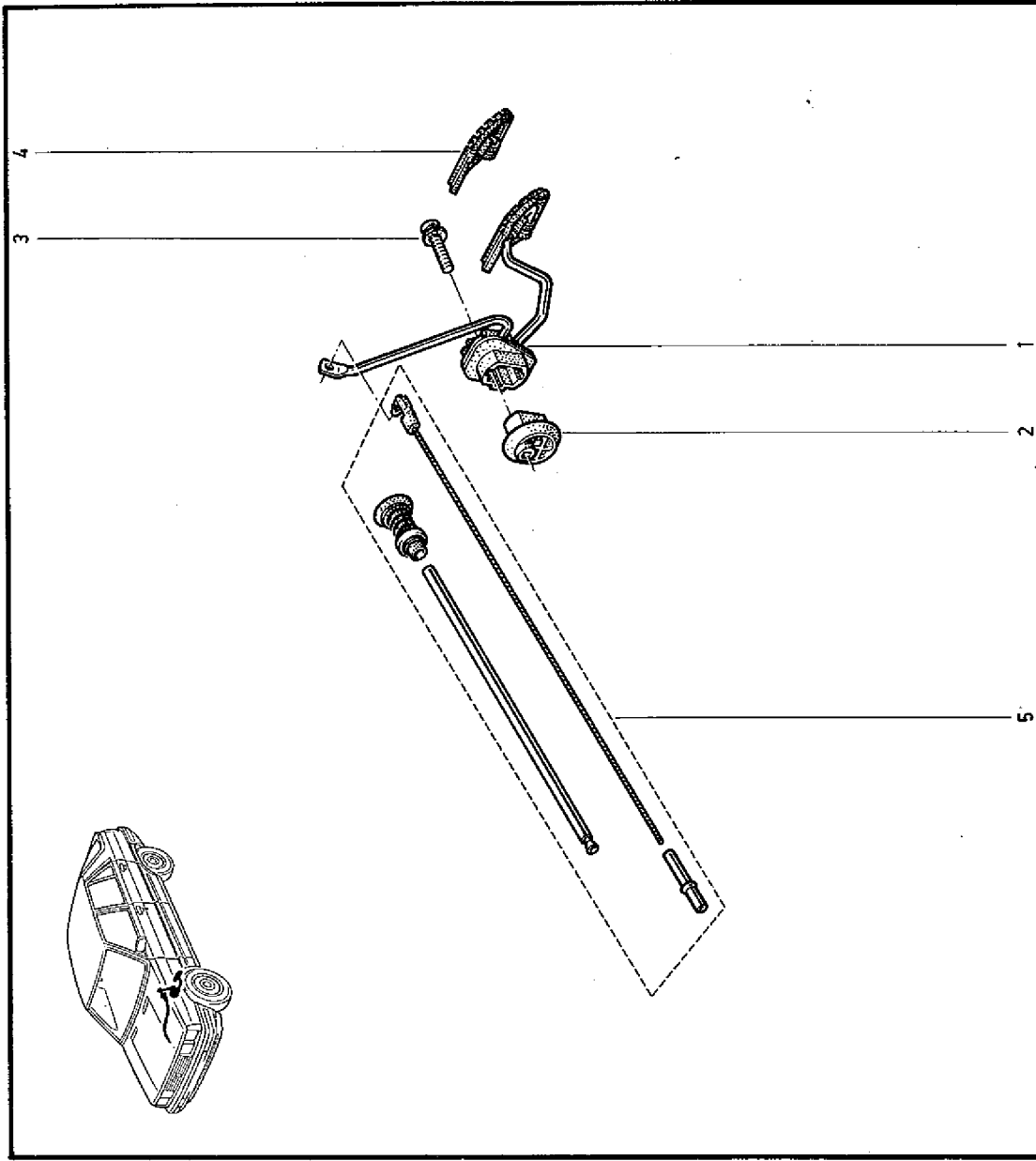

(a) /B.372
(b) /B.373

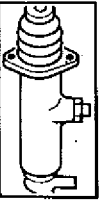

37.40
C.R.H037

- 1 - 77 02 080 911 (B)
- 77 02 073 904 (A)
- 2 - 77 02 089 218 (A)
- 3 - 77 02 073 905 (A)
- 77 02 073 928 (B)
- 4 - 77 02 073 907 (A)
- 77 02 073 922 (B)
- 5 - 77 02 073 919 (B)
- 77 02 073 927 (A)
- 77 01 020 532 (A)
- 6 - 77 02 073 906 (A)
- 77 02 073 920 (B)
- 7 - 79 03 032 012
- 8 - 77 03 055 031

+

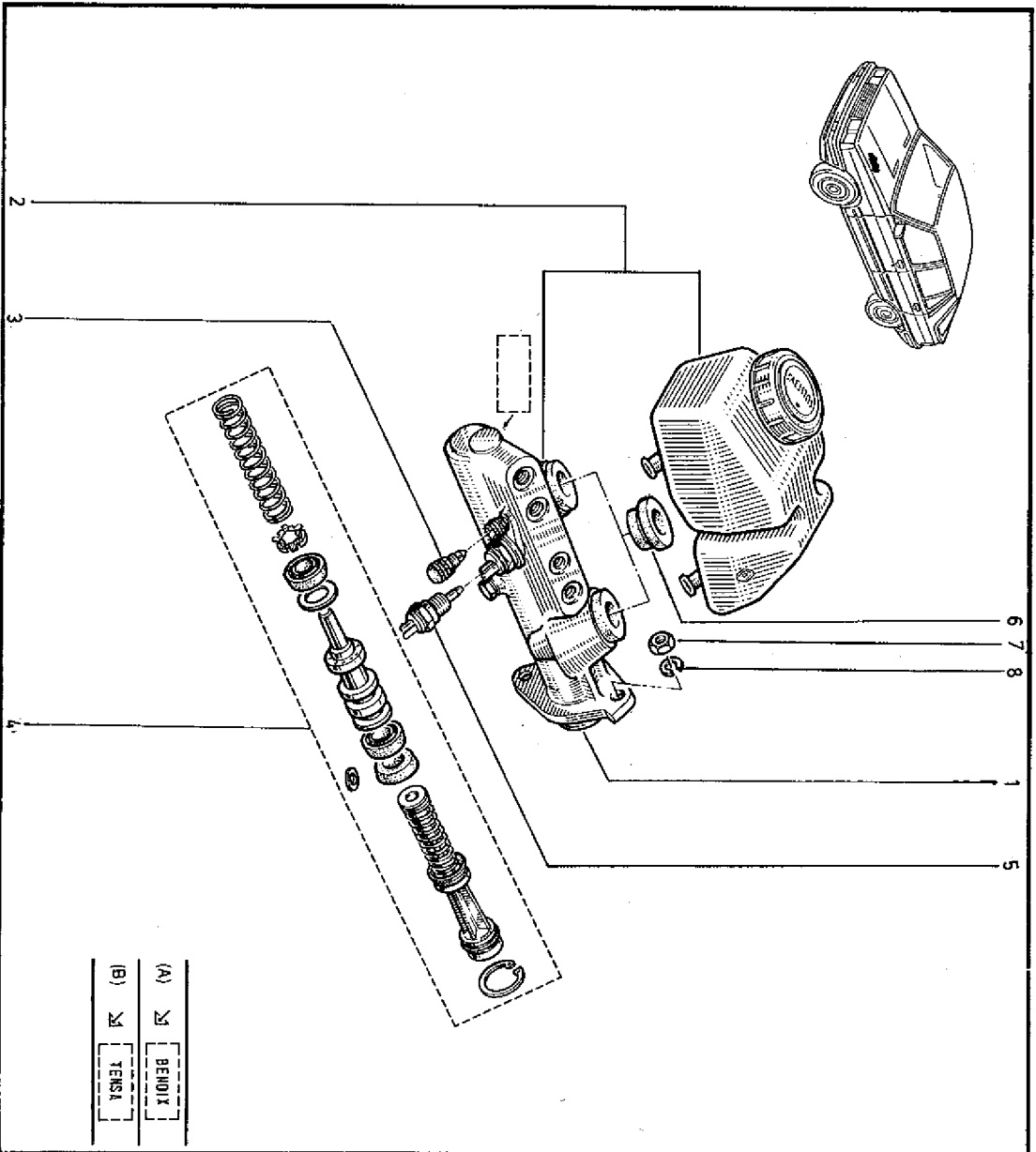

37.40
C.R.H037

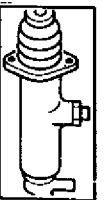

(A)	⊗	BENDIX
(B)	⊗	TENSA



37.50
C.R.1037

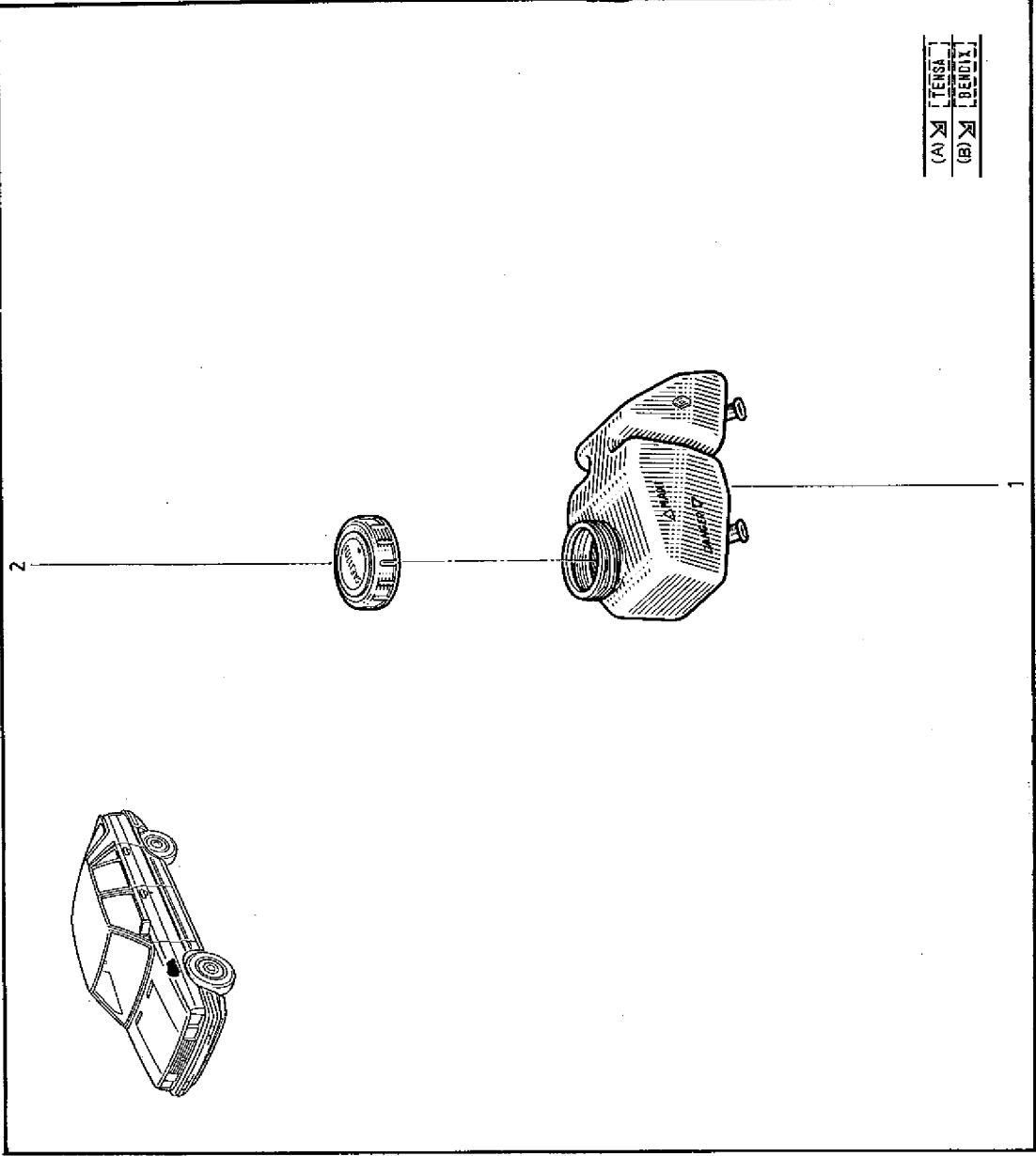

770002080	(A)
770002080	(B)
770002080	(A)
770002080	(B)

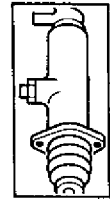

37.50
C.R.1037

- 1 - 77 02 080 914 (A)
- 77 00 625 952 (B)
- 2 - 77 02 080 915 (A)
- 77 00 581 673 (B)



37.60
C.R.11037

- 1 - 77 02 080 954 (B)
- 77 00 686 539 (A)
- 2 - 77 00 582 463 (b) (M 655) †
- 77 02 085 280 < 1m
- 77 00 575 126 (a) (M 535) †
- 77 02 083 280 < 1m
- 77 02 085 433 (b) (M 655) †
- 77 02 085 430 (a) (M 535) †
- 3 - 77 00 616 988
- 4 - 79 03 056 014
- 5 - 77 03 034 037
- 6 - 77 03 050 085 †
- 07 05 328 400
- 7 - 10 89 020 200
- 8 - 77 01 202 004 (A)
- 77 02 073 921 (B)
- 9 - 77 02 073 908 (A)
- 77 02 073 918 (B)
- 10 - 77 00 701 608
- 11 - 77 03 079 094
- 12 - 77 02 080 953 (B)
- 77 02 080 955 (A)
- 13 - 77 02 073 269

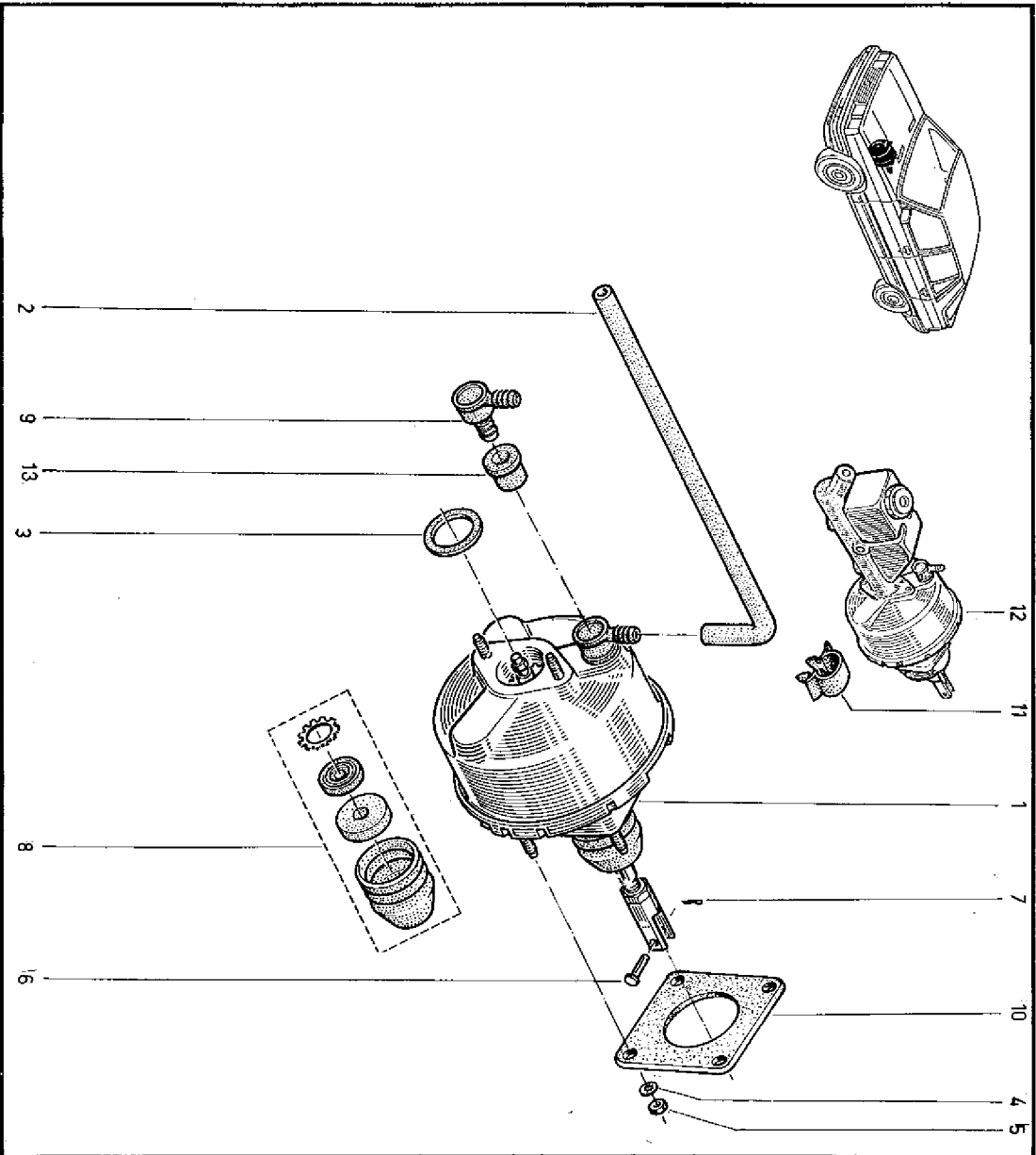

37.60
C.R.11037



(B) / B-372
(b) / B-373

(A) BENDIX

(B) TENS

(A) BENDIX

(B) TENS

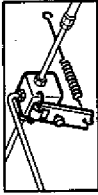

37.70
C.R.1037

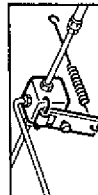
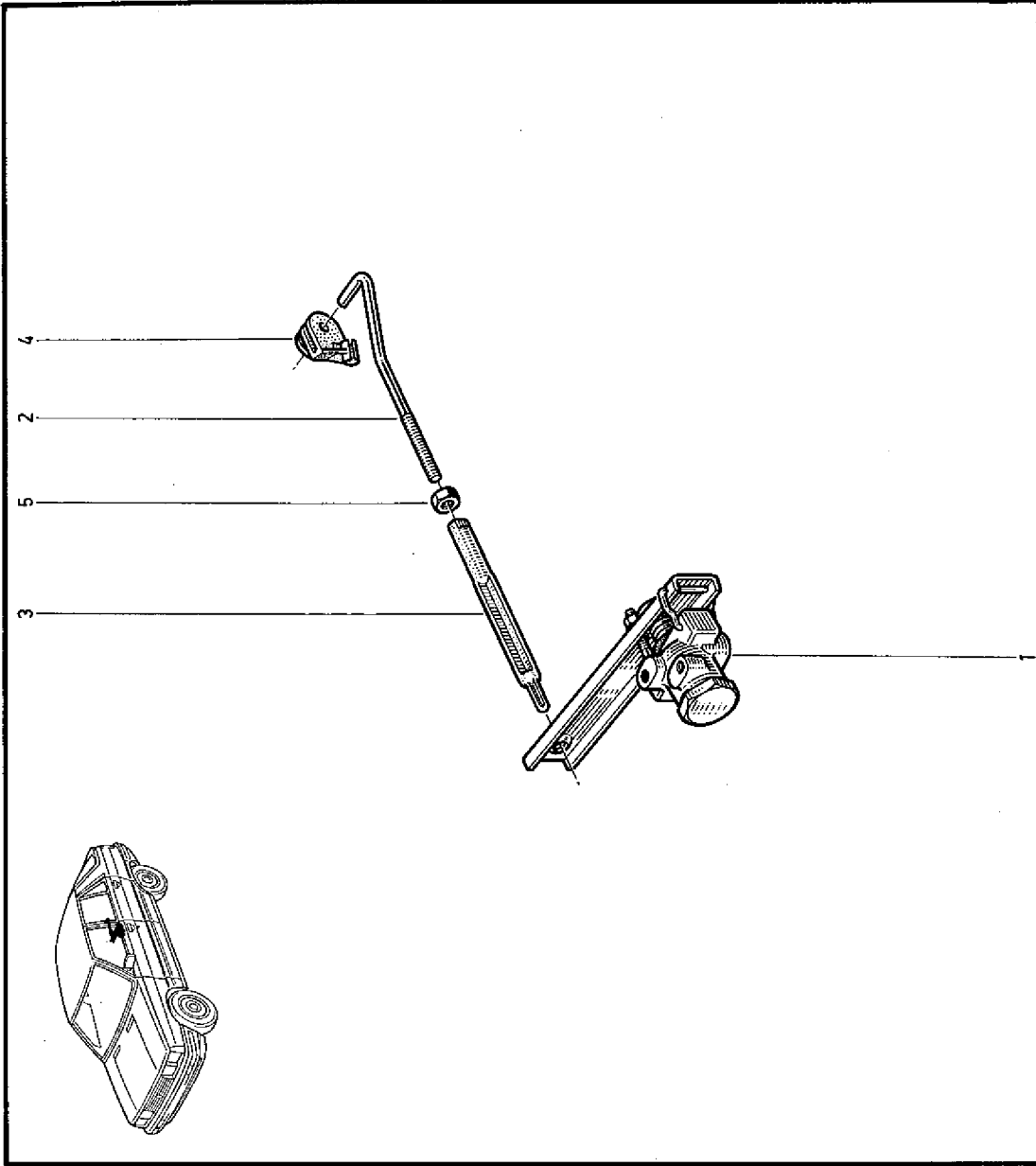

37.70
C.R.1037

- 1 - 77 01 349 306
- 77 02 080 927
- 77 02 093 630
- 2 - 77 00 695 637
- 3 - 77 00 682 665
- 4 - 77 00 639 125
- 5 - 79 03 032 009

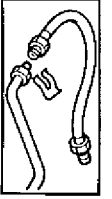

37.80
C.R.1037

- 1 - 77 00 687 386
- 2 - 77 00 687 388
- 3 - 77 00 687 392
- 4 - 77 00 687 390
- 5 - 77 02 080 936
- 6 - 77 04 001 592
- 7 - 77 02 080 937
- 8 - 77 00 685 565
- 9 - 77 00 685 567
- 10 - 77 00 687 396
- 11 - 77 00 687 394
- 12 - 77 03 079 178

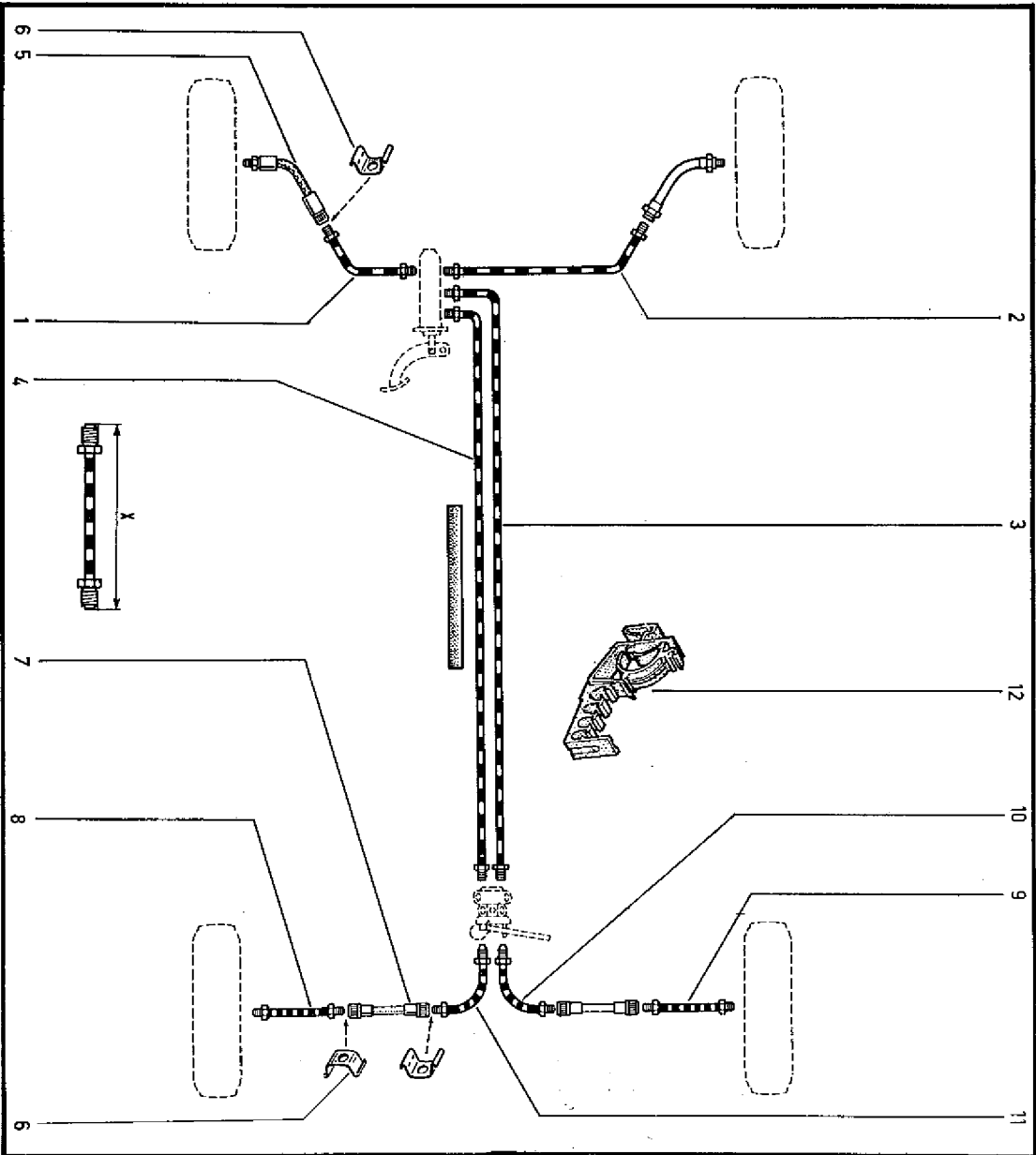

37.80
C.R.1037

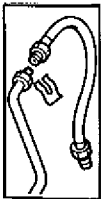

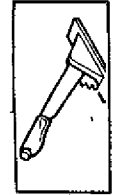

38.01

C.R.1037

- 1 - 77 00 678 723
- 2 - 77 00 662 741
- 3 - 77 00 662 781
- 4 - 77 00 662 784
- 5 - 77 00 662 770
- 6 - 77 03 050 033
- 7 - 77 03 066 150
- 8 - 77 00 662 742
- 9 - 77 03 050 070
- 10 - 77 00 662 783
- 11 - 77 00 699 064
- 12 - 77 00 662 771
- 13 - 77 00 662 782
- 14 - 77 03 066 162
- 15 - 77 03 050 094
- 16 - 77 00 685 683
- 17 - 77 03 001 943
- 18 - 77 03 002 001
- 19 - 77 00 591 208
- 20 - 77 03 050 069
- 21 - 77 03 066 151
- 22 - 79 03 032 018
- 23 - 77 00 553 137
- 24 - 77 00 539 049
- 25 - 06 24 376 400
- 26 - 06 07 110 900
- 27 - 77 03 050 054
- 28 - 10 89 020 302
- 29 - 77 00 682 421
- 30 - 77 02 080 935
- 31 - 77 02 081 044
- 32 - 77 02 085 400 (B = 375)
- 33 - 77 02 085 401 (B = 375)
- 34 - 77 03 079 317
- 35 - 77 03 079 142
- 36 - 77 00 703 941
- 37 - 77 00 703 940

- 34 - 77 05 035 073
- 35 - 77 00 707 118
- 36 - 79 03 053 028



38.01

C.R.1037

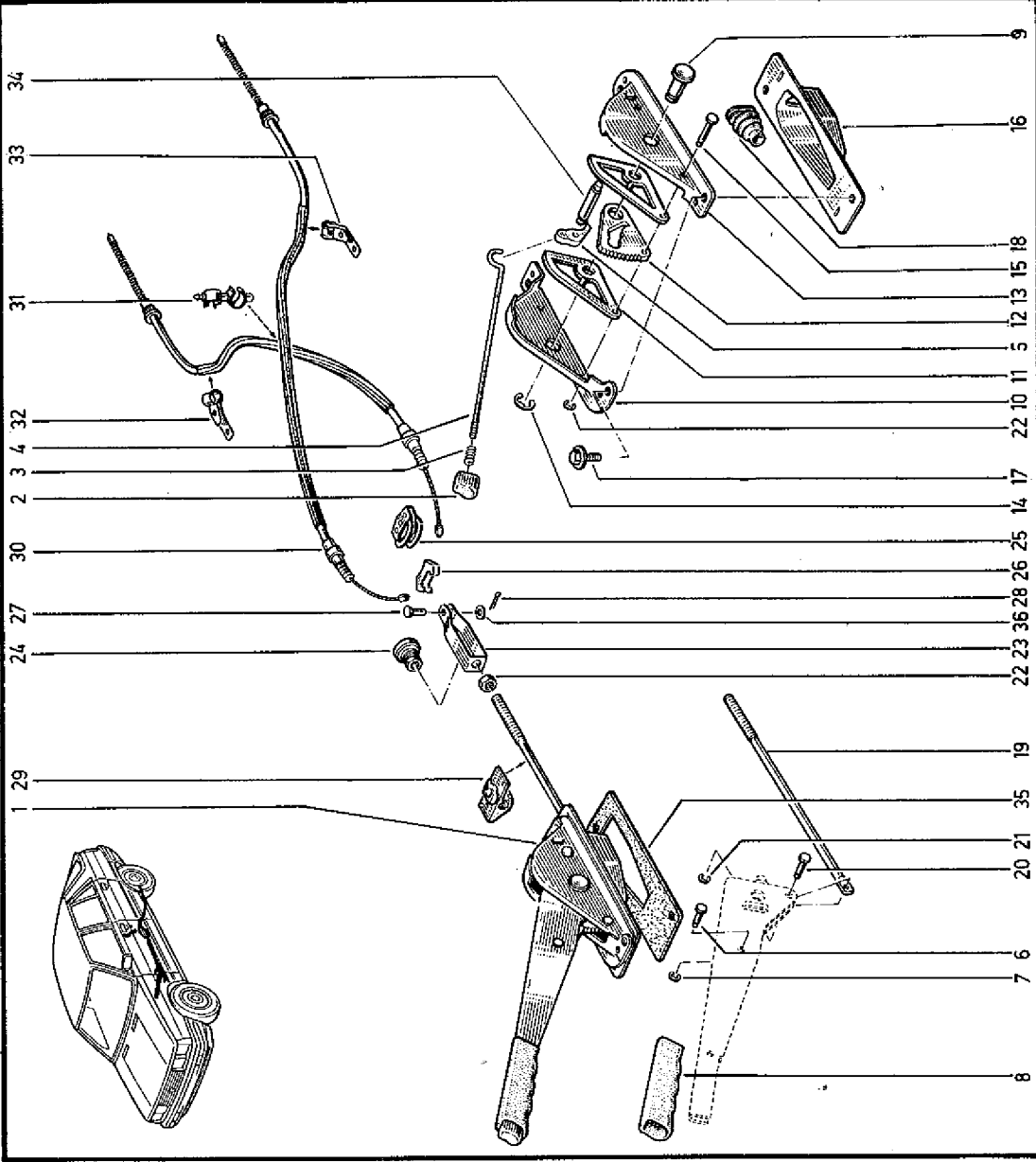

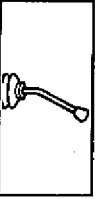

38.20

C.R.1037

1 - 77 00 697 092	31 - 79 03 053 041
77 01 464 163	32 - 77 03 034 037
2 - 77 00 701 955	33 - 77 00 698 015
3 - 77 03 067 271	34 - 77 03 081 028
4 - 77 03 061 115	35 - 77 03 016 142
5 - 77 03 061 155	36 - 77 03 061 116
6 - 77 00 695 566 + (20)	37 - 77 03 073 117
7 - 77 00 695 568 + (20)	38 - 77 03 073 105
8 - 77 00 695 569 + (20)	39 - 77 03 077 021
9 - 77 00 695 567 + (20)	40 - 77 01 464 111
10 - 77 00 694 733	40 - 77 01 464 164
11 - 77 03 066 853 + (20)	
12 - 77 00 696 719 + (21)	
13 - 77 00 727 887 + (21)	
14 - 50 01 000 813 + (21)	
15 - 77 05 015 137 + (21)	
16 - 77 00 696 721 + (21)	
17 - 77 03 067 270 + (21)	
18 - 77 03 067 272 + (21)	
18 - 77 04 001 309 EA1*	
77 04 001 310 EA1*	
77 04 003 731 EA1 B375	
19 - 77 00 698 329	
20 - 77 03 061 121	
21 - 77 00 653 337	
21 - 77 03 019 080	
22 - 77 03 019 088	
22 - 77 00 722 941 +	
77 00 727 971 +	
77 00 728 749 a)	
77 02 094 447 b)	
23 - 77 03 074 114	
24 - 77 00 579 550	
25 - 77 03 001 240	
26 - 77 03 053 521	
27 - 79 03 032 018	
28 - 77 00 722 942	
29 - 77 05 010 083	
30 - 77 03 101 196	
77 03 001 240	

B372	□	n°	1	→	n°
B373	□	n°	1	→	n°
B374	□	n°	1	→	n°
B375	□	n°	1	→	n°
B376	□	n°	1	→	n°
B377	□	n°	1	→	n°
B378	□	n°	1	→	n°
B379	□	n°	1	→	n°
B380	□	n°	1	→	n°
B381	□	n°	1	→	n°
B382	□	n°	1	→	n°
B383	□	n°	1	→	n°
B384	□	n°	1	→	n°
B385	□	n°	1	→	n°
B386	□	n°	1	→	n°
B387	□	n°	1	→	n°
B388	□	n°	1	→	n°
B389	□	n°	1	→	n°
B390	□	n°	1	→	n°
B391	□	n°	1	→	n°
B392	□	n°	1	→	n°
B393	□	n°	1	→	n°
B394	□	n°	1	→	n°
B395	□	n°	1	→	n°
B396	□	n°	1	→	n°
B397	□	n°	1	→	n°
B398	□	n°	1	→	n°
B399	□	n°	1	→	n°
B400	□	n°	1	→	n°

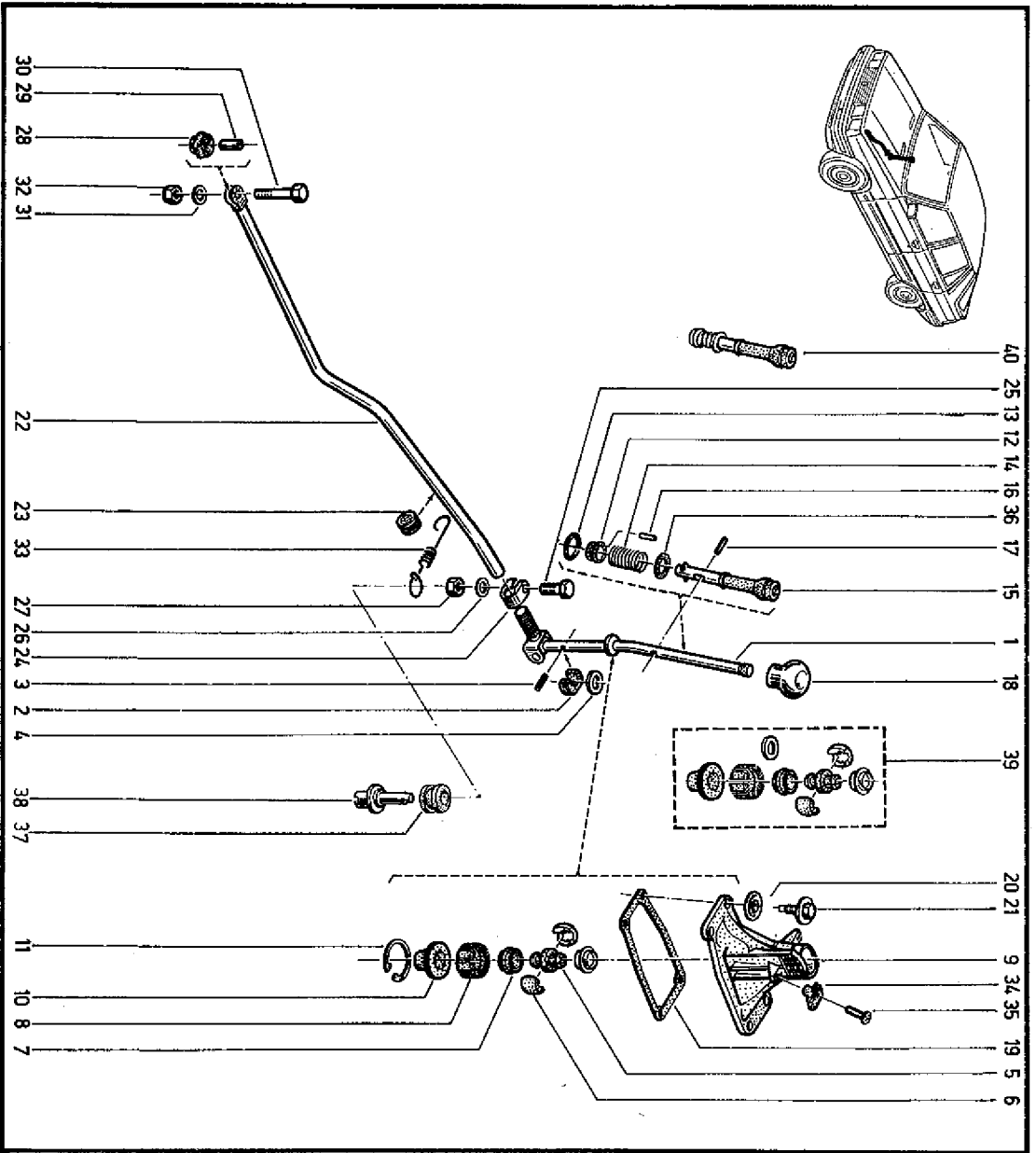

38.20

C.R.1037

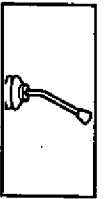

(20) □ 77 01 484 111 - 1
 (21) □ 77 01 484 164 - 1

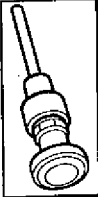

38.40
C.R.1037

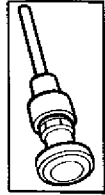
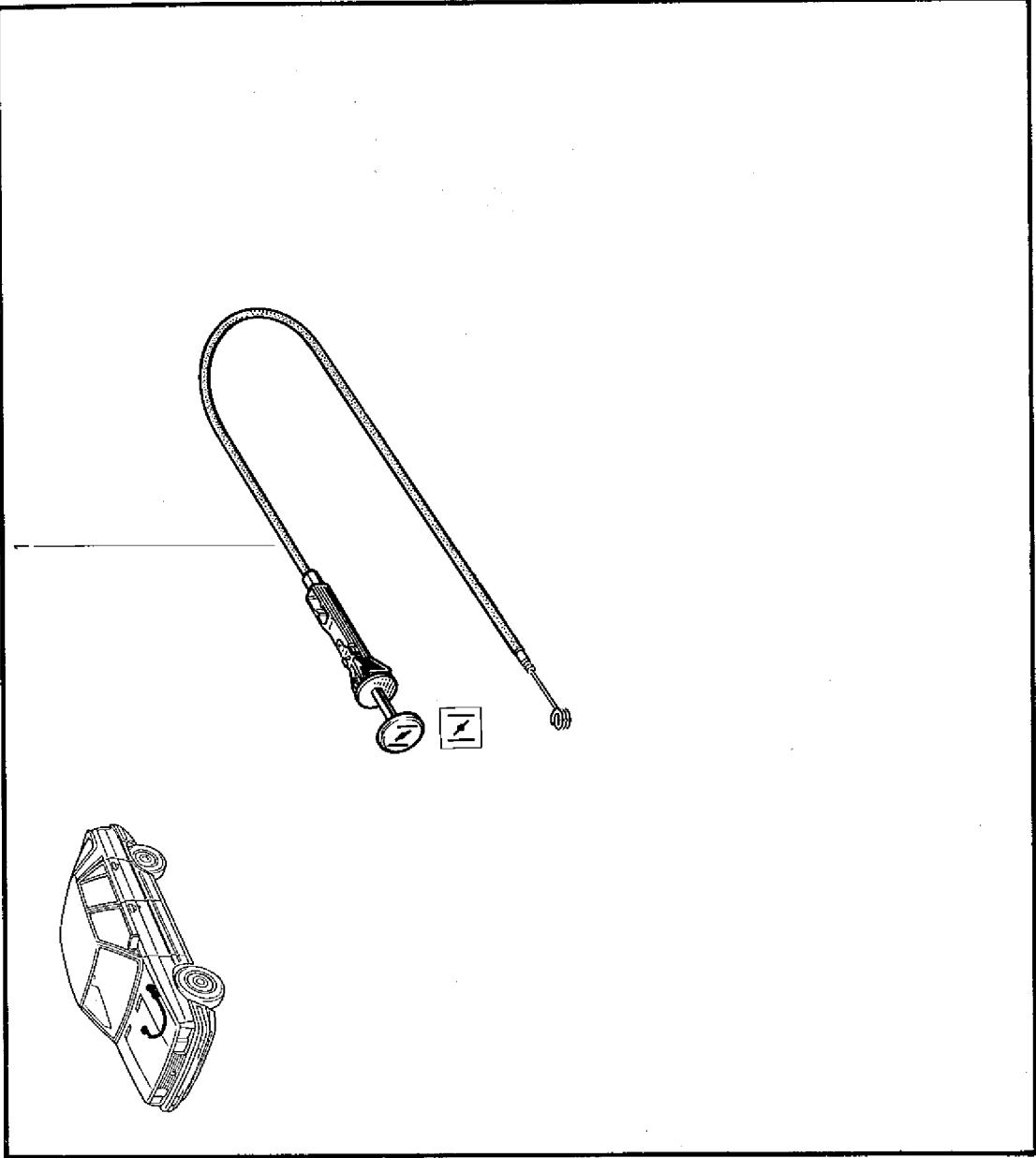

38.40
C.R.1037

1 - 77 04 003 830
77 04 003 918 (B-375)



1 - 77 02 073 698

40.01
C.R.1037

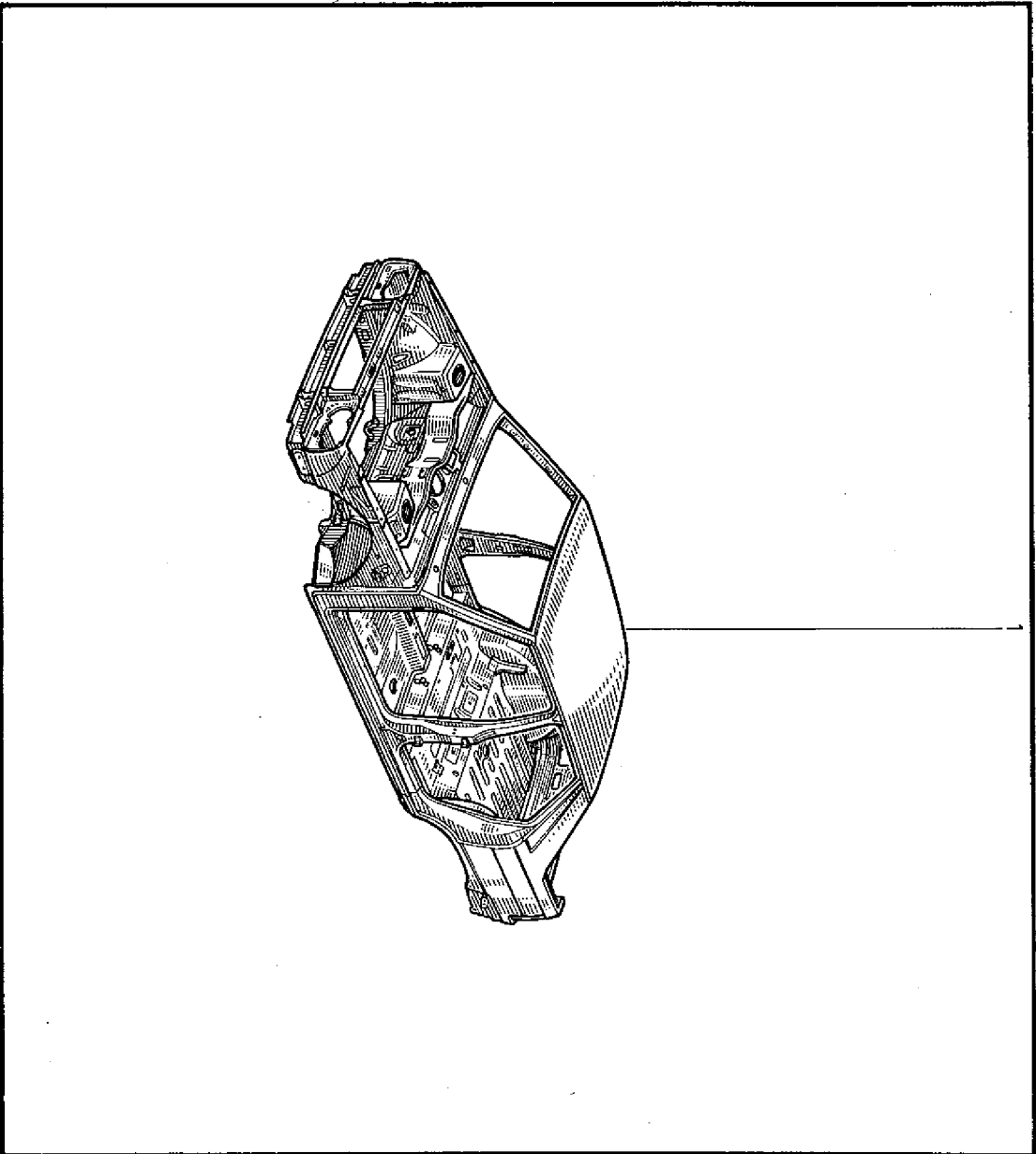

40.01
C.R.1037





40.10
C.R.1037

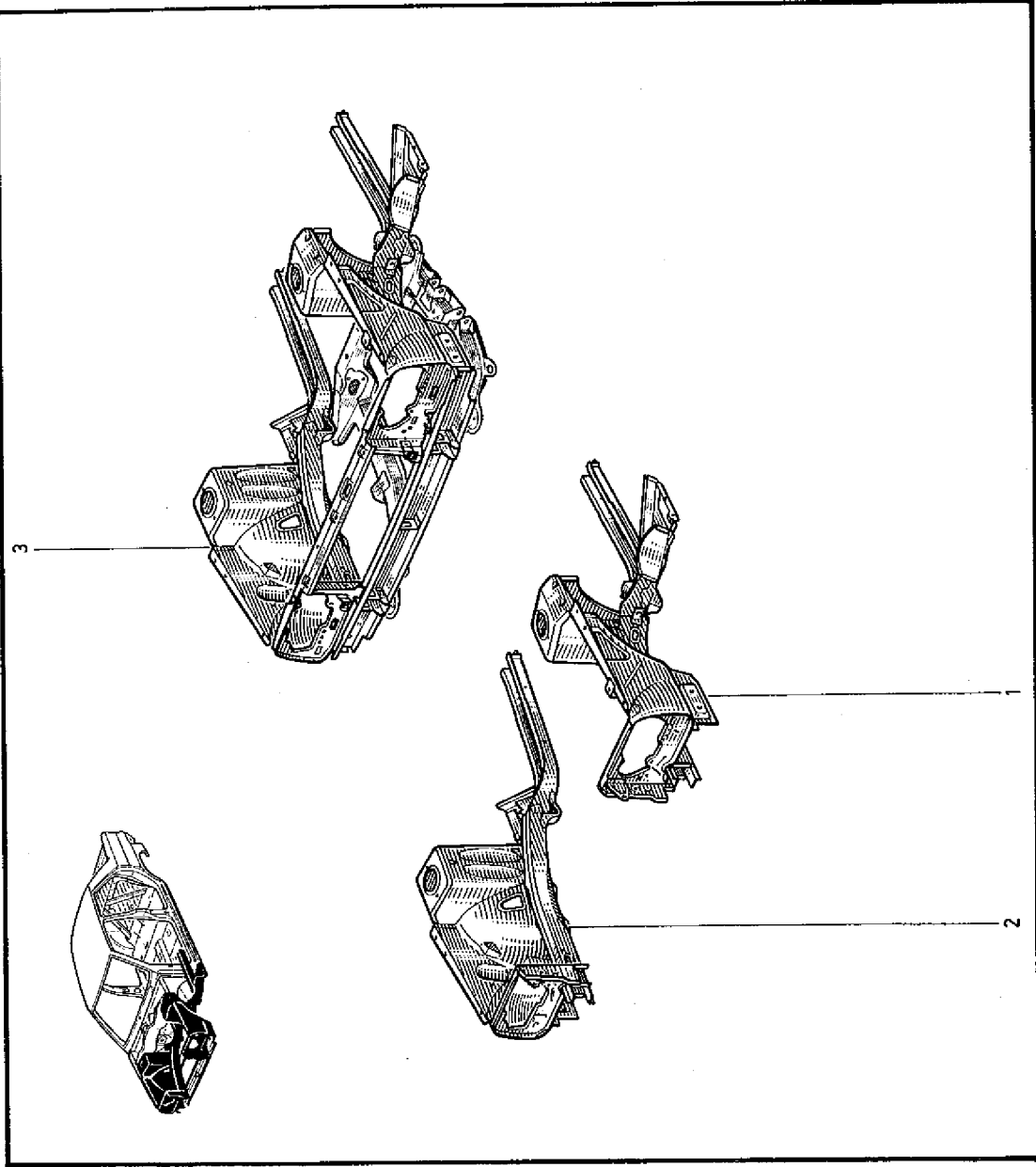

40.10
C.R.1037



- 1 - 77 02 073 771
- 2 - 77 02 073 769
- 3 - 77 02 073 774



41.10
C.R.1037

- 1 - 77 02 073 388
- 2 - 77 02 073 393
- 3 - 77 00 674 643
- 4 - 77 02 073 391
- 5 - 77 00 679 094
- 6 - 77 02 073 390
- 7 - 77 02 073 394
- 8 - 77 00 674 644
- 9 - 77 02 073 392
- 10 - 77 00 679 379
- 11 - 77 02 073 395
- 12 - 77 02 080 983
- 13 - 77 02 073 396
- 14 - 77 02 073 397
- 15 - 77 02 073 398
- 16 - 77 02 073 399

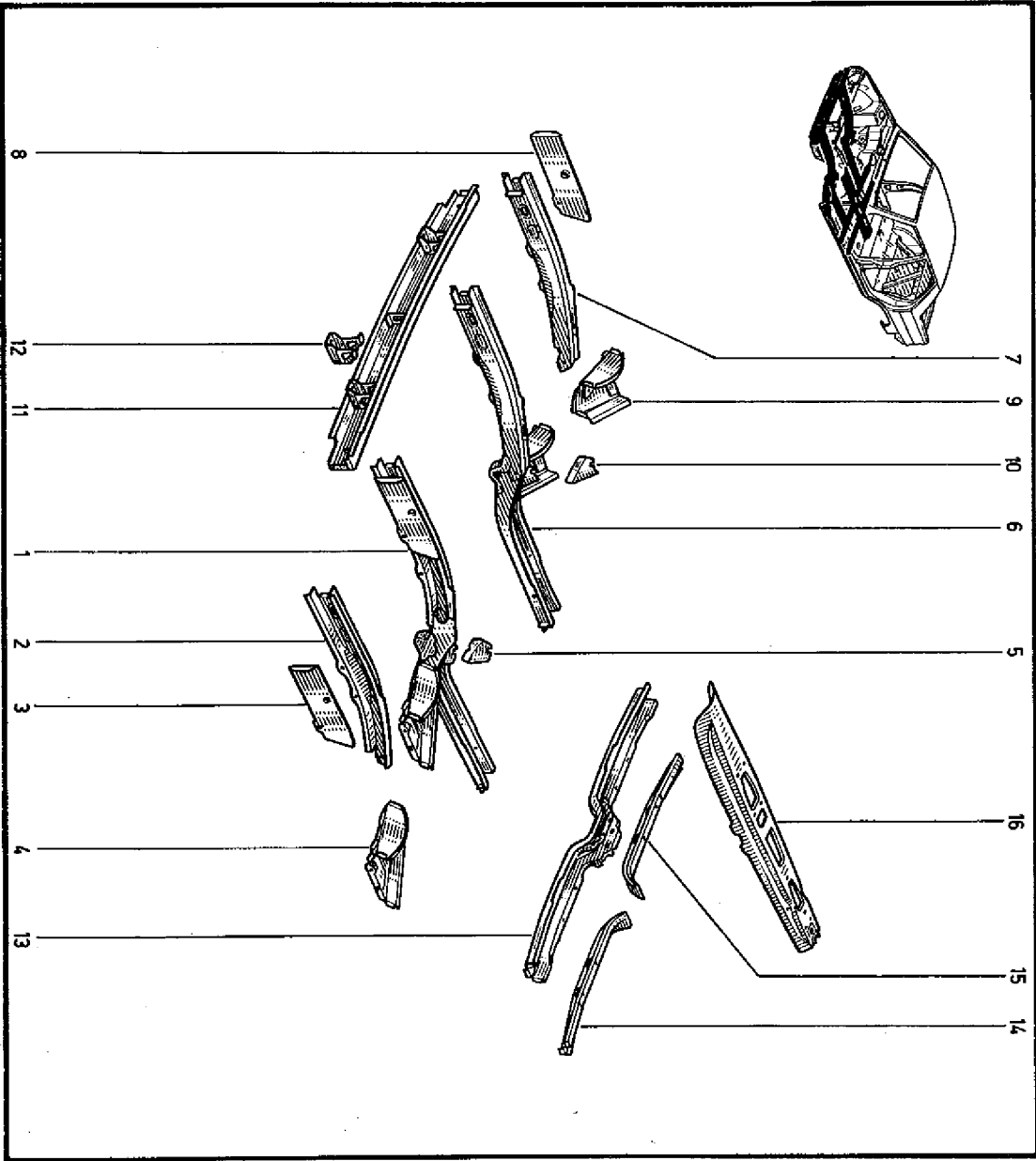

41.10
C.R.1037



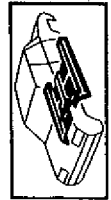

41.20
C.R.1037

- 1 - 77 02 073 485
- 2 - 77 02 073 426
- 3 - 77 02 073 427
- 4 - 77 00 682 058
- 5 - 77 00 698 034
- 6 - 77 00 698 035
- 7 - 77 00 698 036



41.20
C.R.1037

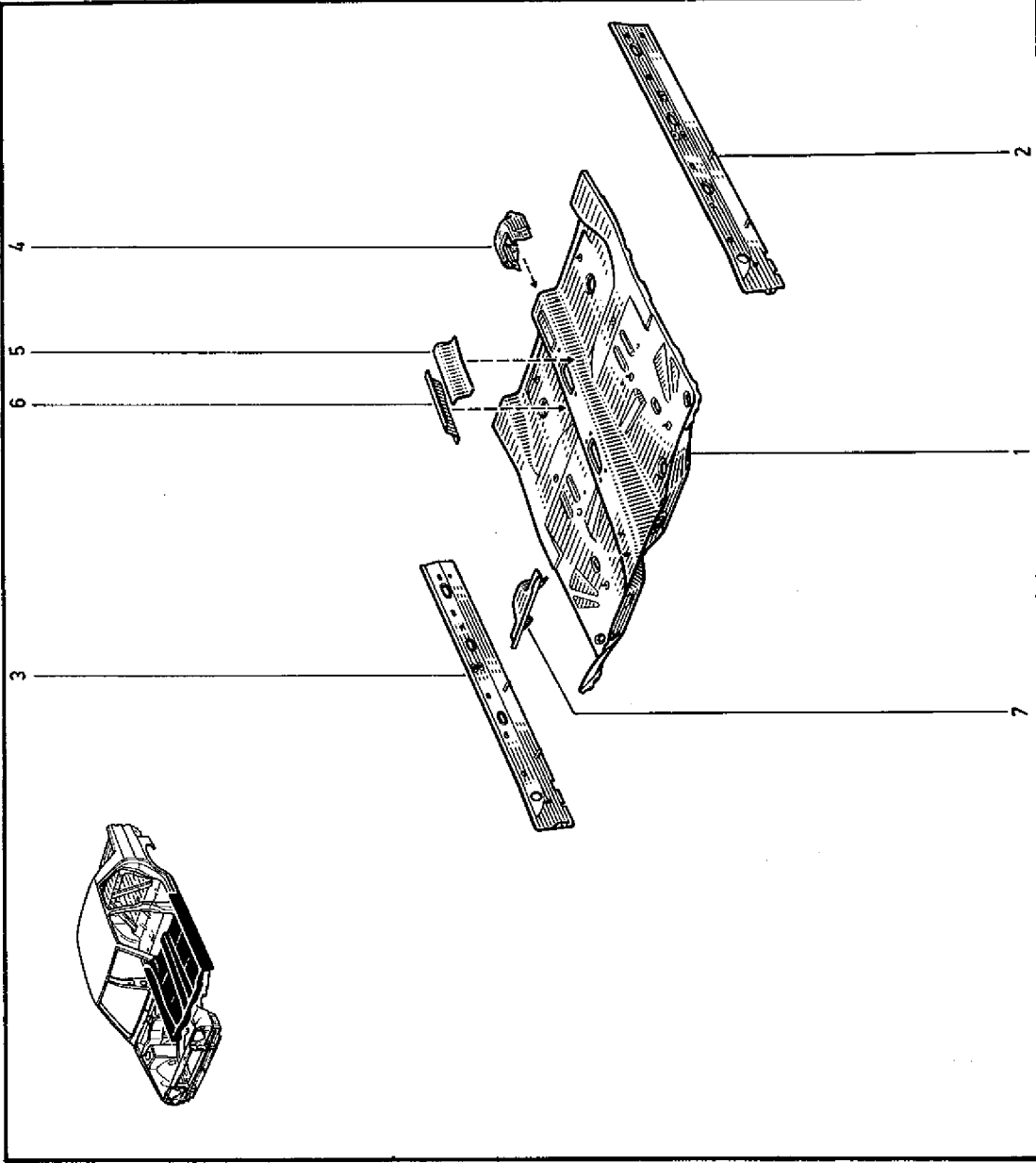

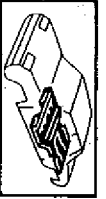

41.30
C.R.1037

- 1 - 77 02 073 715
- 2 - 77 01 462 587 +
- 3 - 77 02 073 658
- 4 - 77 00 694 811
- 5 - 77 02 073 404
- 6 - 77 02 073 406
- 7 - 77 02 073 407
- 8 - 77 02 073 659
- 9 - 77 02 073 405
- 10 - 77 02 073 657
- 11 - 77 02 073 660
- 12 - 77 02 073 402
- 13 - 77 02 073 403
- 14 - 77 00 717 867
- 15 - 77 03 088 050
- 16 - 77 03 074 171
- 17 - 77 03 044 094
- 18 - 77 03 002 007
- 19 - 77 00 712 616
- 20 - 77 00 717 740
- 21 - 77 02 073 656
- 22 - 77 00 717 846
- 23 - 77 00 757 168
- 24 - 77 02 080 959 (a)
- 25 - 1018489
- 26 - 6070838
- 27 - 1018488
- 28 - 77 02 085 393 (B-375)
- 29 - 77 02 085 402 (B-375)
- 30 - 79 03 032 028 (B-375)

41.30
C.R.1037

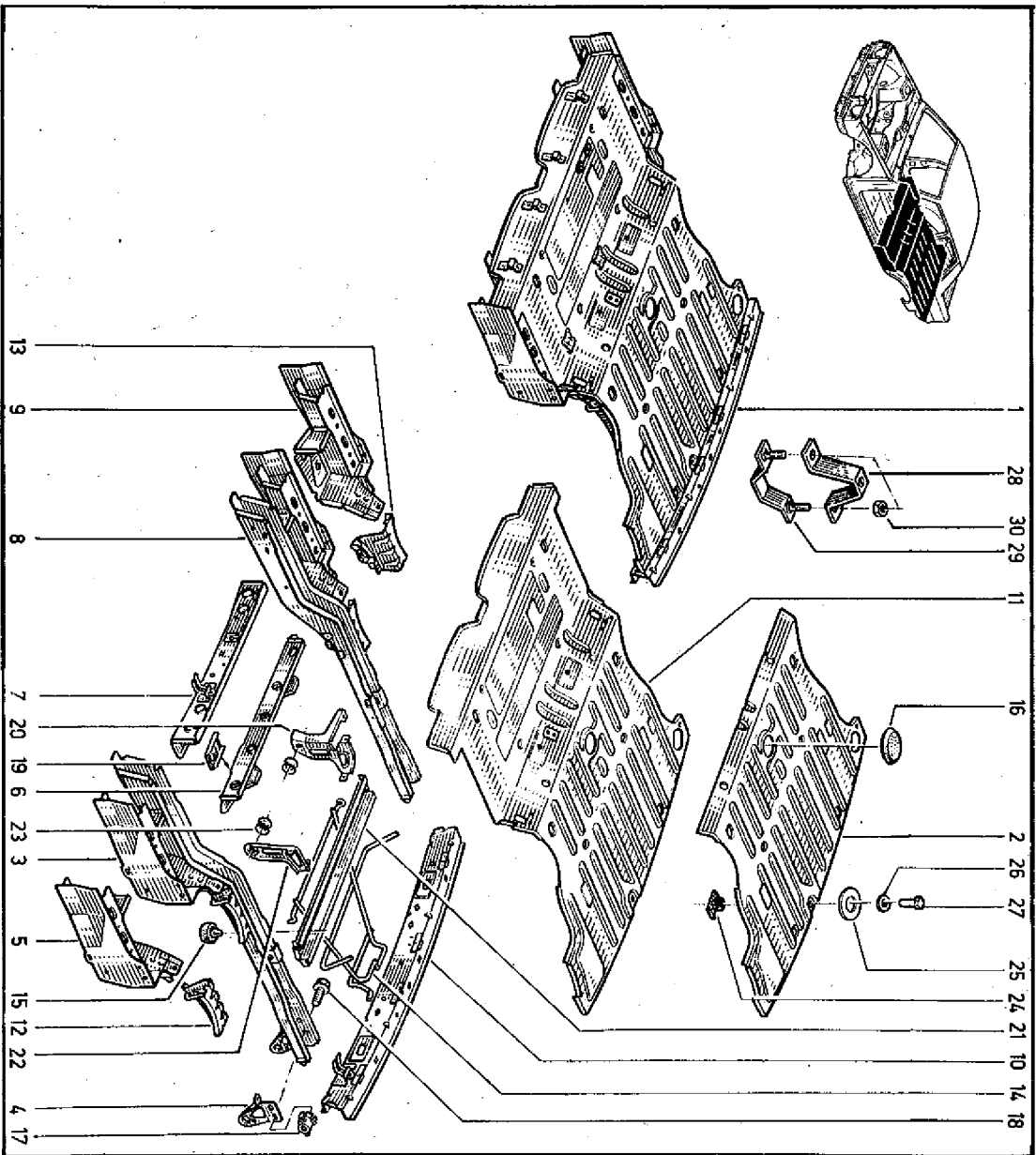

(a)

B372	n°	1	n°
B373	n°	1	n°
B37E	n° MOD	1986	n°



42.01
C.R.1037

- 1 - 77 01 598 769 †
- 77 00 686 185 †
- 77 02 073 366
- 2 - 77 00 687 315
- 77 02 073 368
- 3 - 77 01 592 739 †
- 77 00 680 648
- 77 02 083 325 †
- 77 02 083 326
- 4 - 77 03 044 097
- 5 - 77 01 590 374
- 77 02 073 388
- 77 02 089 263
- 6 - 77 00 678 621 †
- 77 02 073 750
- 7 - 77 00 714 043
- 8 - 77 03 019 085
- 9 - 79 03 053 031
- 10 - 77 03 055 007
- 11 - 79 03 032 009
- 12 - 77 02 081 439
- 13 - 79 03 053 031
- 14 - 77 03 055 007
- 15 - 79 03 032 009



42.01
C.R.1037

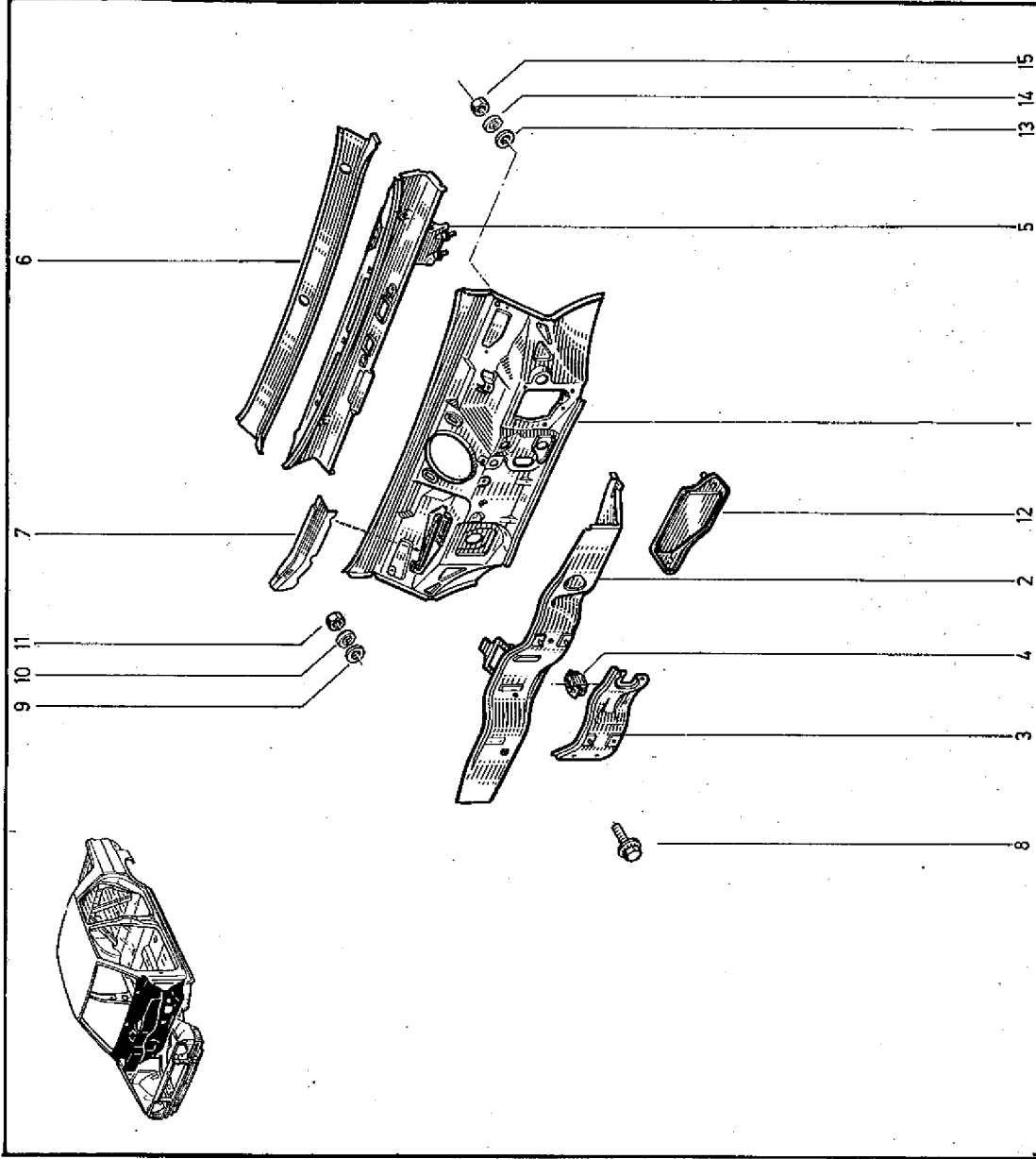



42.10
C.R.1037

- 1 - 77 02 073 483
- 2 - 77 00 751 020 +
- 77 02 073 867
- 3 - 77 02 073 484
- 4 - 77 00 686 429 +
- 77 02 088 573
- 5 - 77 01 590 365 (a)
- 77 02 083 557 (b)
- 77 02 206 213 (b)
- 6 - 77 01 590 366 (a)
- 77 02 083 556 (b)
- 77 02 206 214 (b)
- 7 - 77 00 711 929 (a)
- 77 00 774 836 (b) (80)
- 8 - 77 00 679 885
- 9 - 77 02 073 737
- 10 - 77 00 680 476
- 11 - 77 02 073 738
- 12 - 77 00 752 541
- 13 - 77 00 714 039
- 14 - 77 00 714 040
- 15 - 77 00 751 555
- 16 - 77 03 072 181
- 17 - 77 00 756 798 (B - 375)
- 18 - 77 00 759 606 (B - 375)

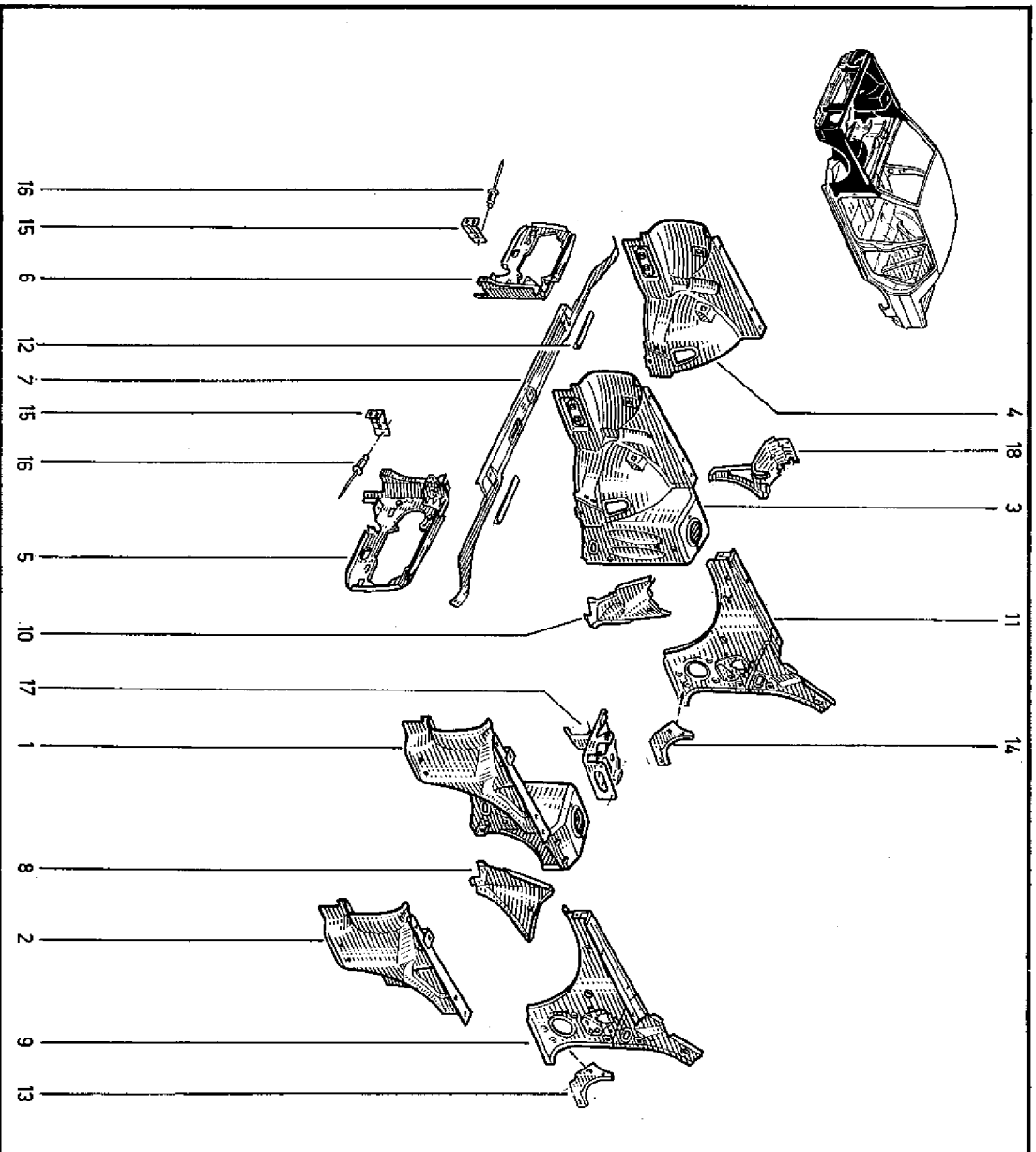

42.10
C.R.1037



(a)

B375		n°	1		n°	00280
B372		n°	1		n°	08014
B373		n°	1		n°	16581

(b)

B372		n°	08015		n°	...
B373		n°	16582		n°	...
B37E		n°	1		n°	...
B37S		n°	00281		n°	...

(80) 77 02 083 567-1
77 02 083 556-1



43.01
C.R.1037

- 1 - 77 01 461 611
- 2 - 77 02 089 221
- 3 - 77 01 461 605
- 4 - 77 02 089 223
- 5 - 77 01 461 609
- 6 - 77 02 089 241
- 7 - 77 01 461 607
- 8 - 77 02 089 232
- 9 - 77 01 589 774
- 10 - 77 02 089 251
- 11 - 77 01 461 617
- 12 - 77 02 089 235
- 13 - 77 01 461 612
- 14 - 77 02 089 220
- 15 - 77 01 461 606
- 16 - 77 02 089 226
- 17 - 77 01 461 610
- 18 - 77 02 089 244
- 19 - 77 01 461 608
- 20 - 77 02 089 229
- 21 - 77 01 589 775
- 22 - 77 01 461 616
- 23 - 77 02 089 238
- 24 - 77 01 610 952 †
- 25 - 77 02 206 215
- 26 - 77 03 088 046
- 27 - 77 00 634 732
- 28 - 77 00 635 003
- 29 - 77 00 673 266
- 30 - 77 03 008 001
- 31 - 77 00 679 913
- 32 - 77 01 586 652
- 33 - 77 00 687 151
- 34 - 77 02 088 589
- 35 - 77 00 679 914
- 36 - 77 01 586 653
- 37 - 77 00 687 152
- 38 - 77 02 088 588

- 25 - 77 00 722 743
- 26 - 77 00 679 912 †
- 27 - 02 206 236
- 28 - 77 01 612 376
- 29 - 77 00 714 041
- 30 - 77 00 714 042
- 31 - 77 00 634 733
- 32 - 77 00 689 337
- 33 - 77 00 699 338

43.01
C.R.1087

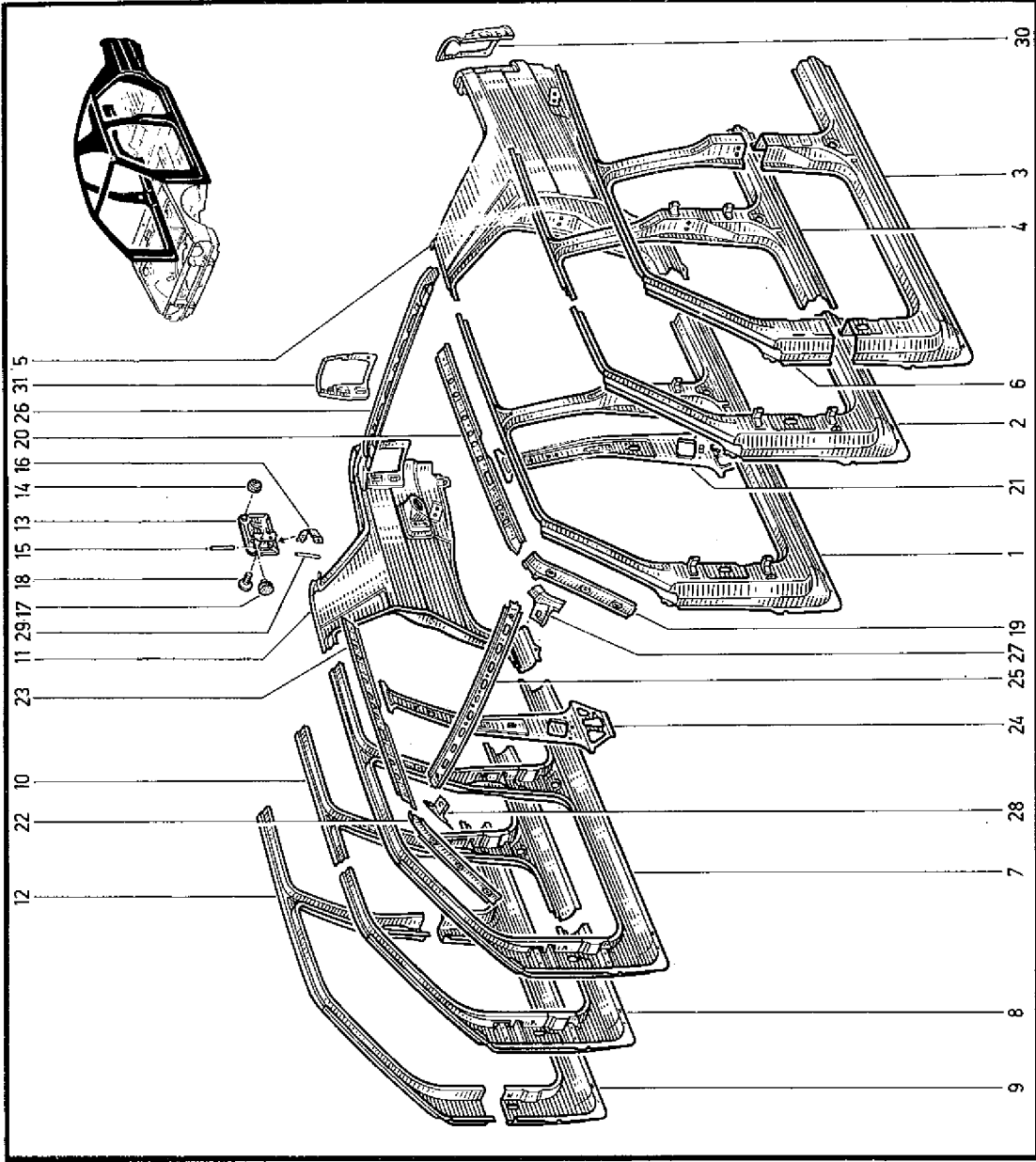

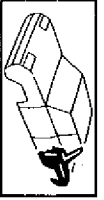

44.01
C.R.1037

- 1 - 77 01 463 224 †
- 77 02 089 497
- 2 - 77 00 679 909
- 3 - 77 01 589 786
- 4 - 77 01 589 782
- 5 - 77 01 463 225 †
- 77 02 089 498
- 6 - 77 00 679 910
- 7 - 77 01 589 787
- 8 - 77 01 589 783
- 9 - 77 00 753 294
- 10 - 77 00 753 295
- 11 - 77 00 615 445
- 12 - 79 03 053 043
- 13 - 77 03 047 007
- 14 - 77 00 517 585
- 15 - 77 02 074 013

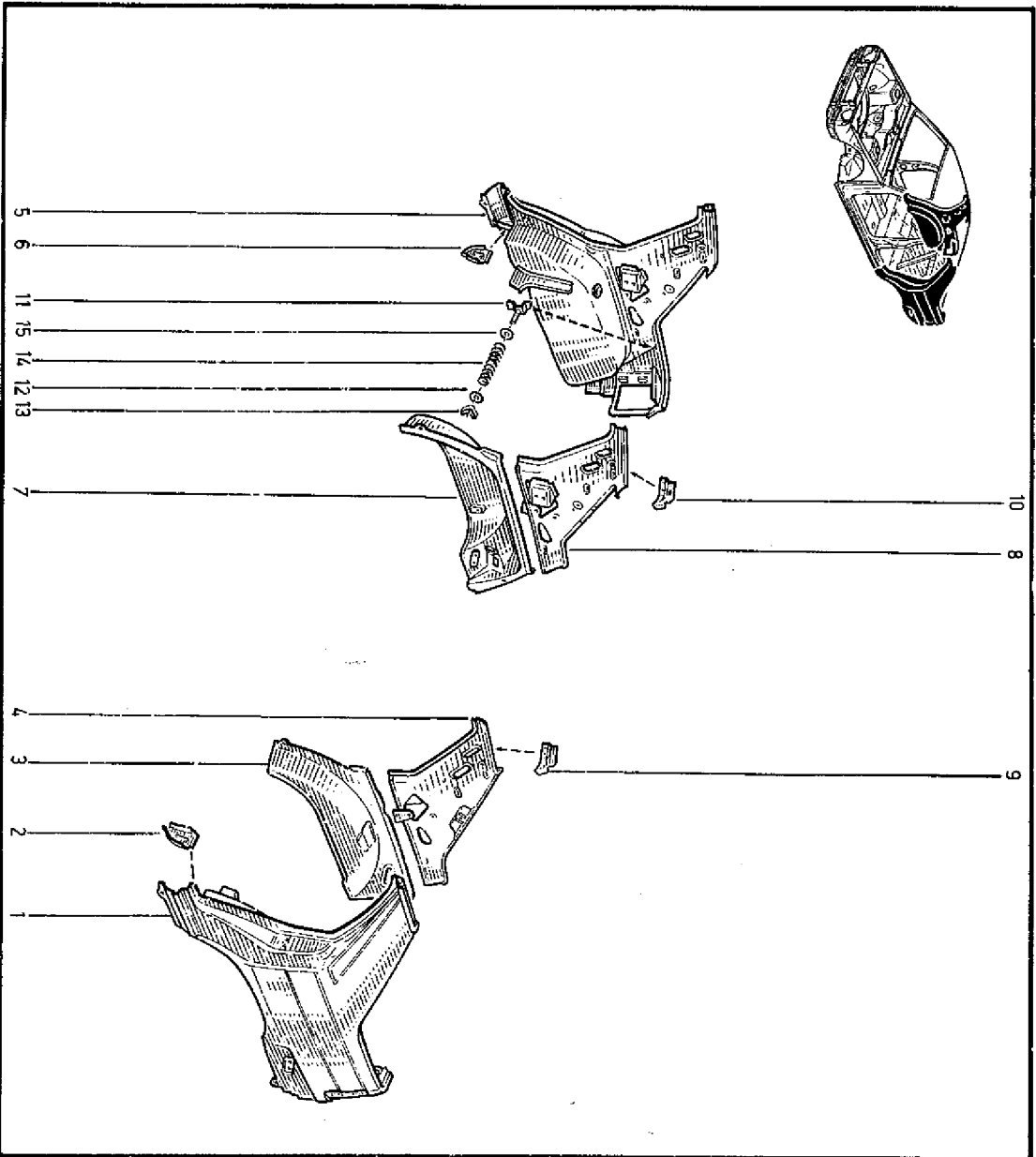

44.01
C.R.1037

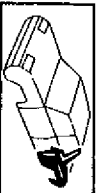



44.20
C.R.1037

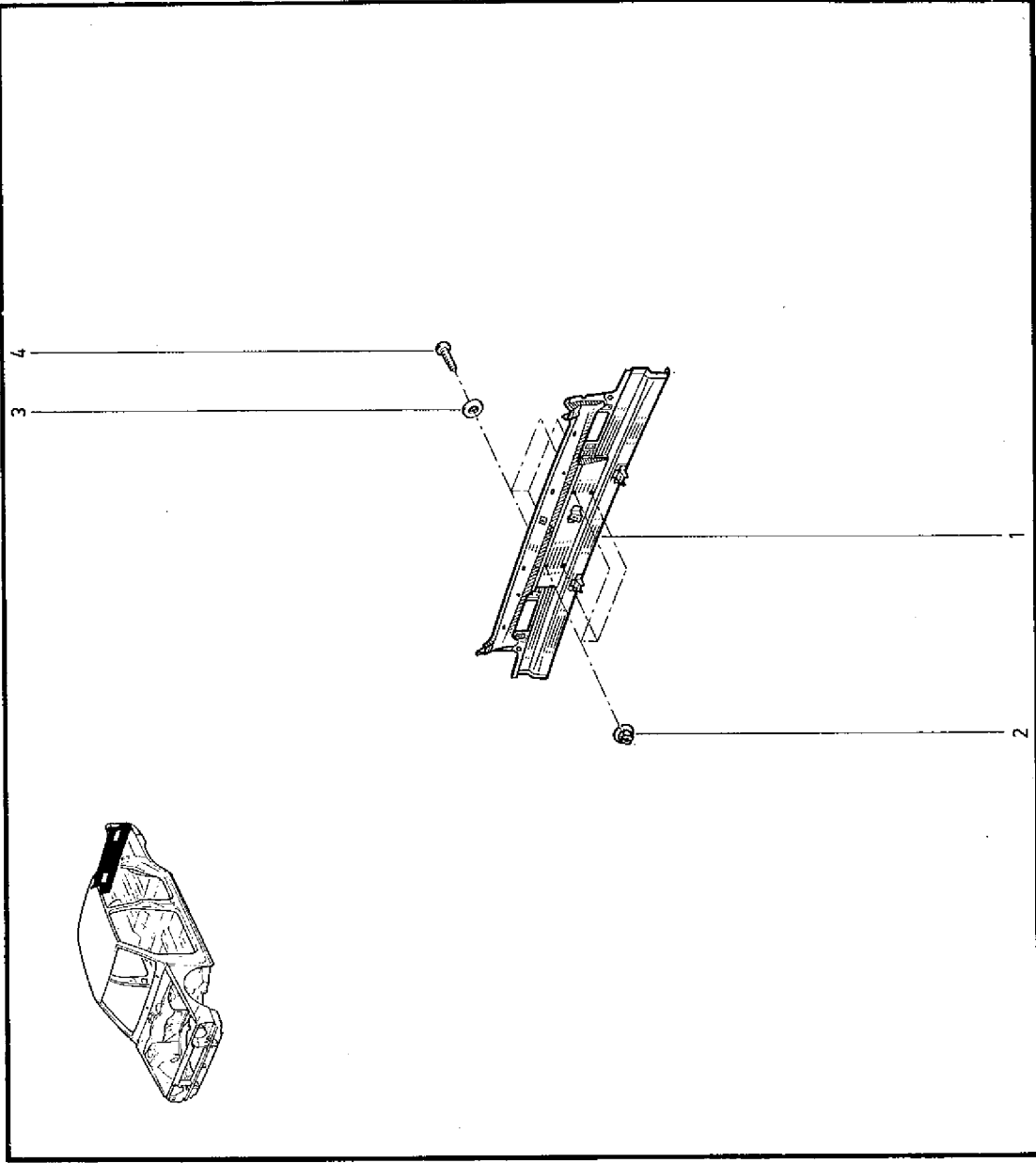

44.20
C.R.1037

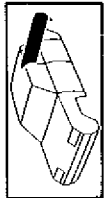

- 1 - 77 02 073 751
- 2 - 77 02 026 192
- 3 - 06 06 786 700
- 4 - 9900979

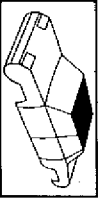

1 - 77 02 073 749

45.01
C.R.1037

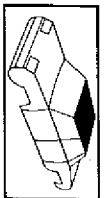
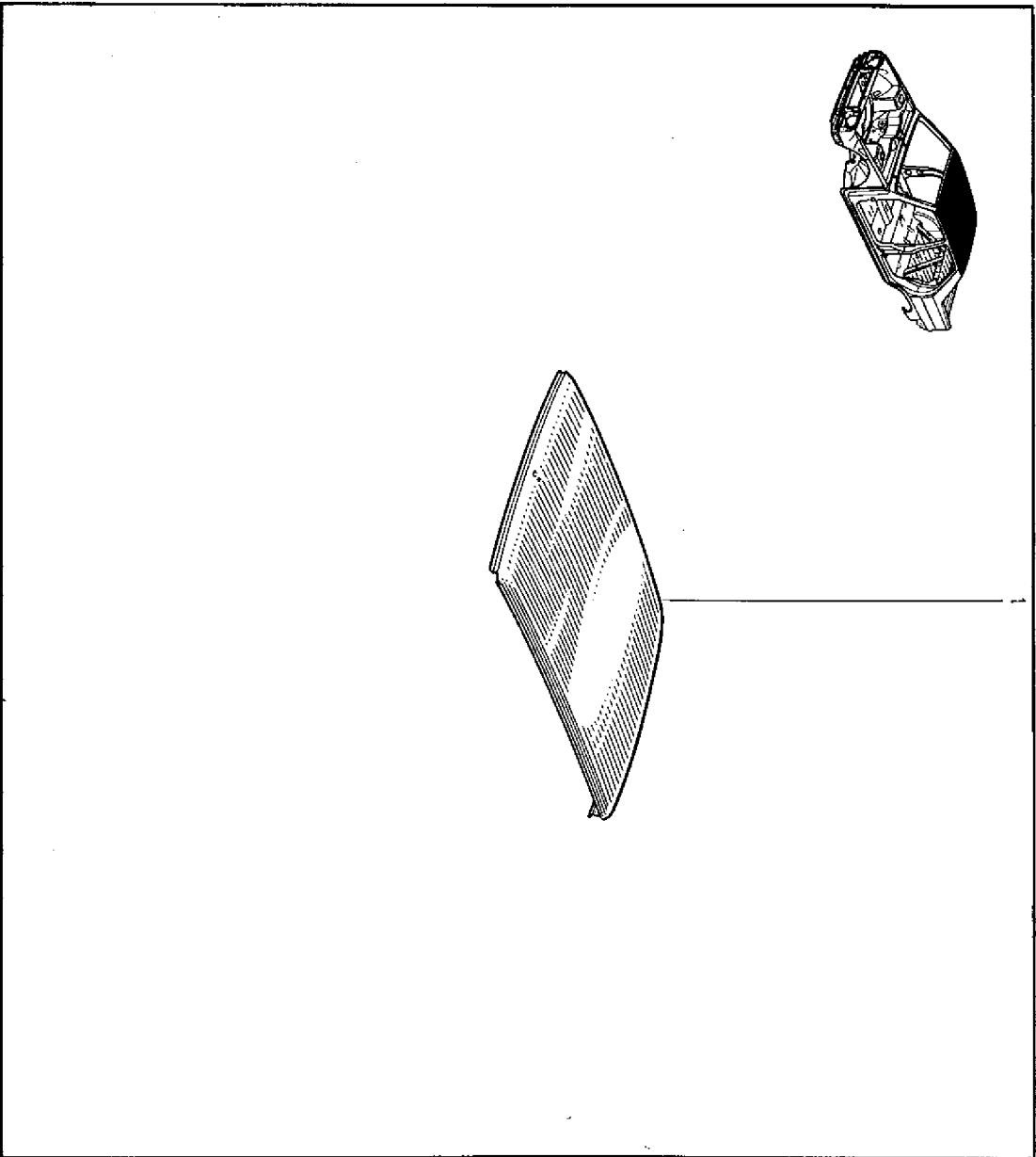

45.01
C.R.1037

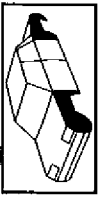

46.01
C.R.1037

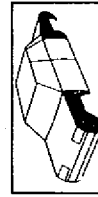
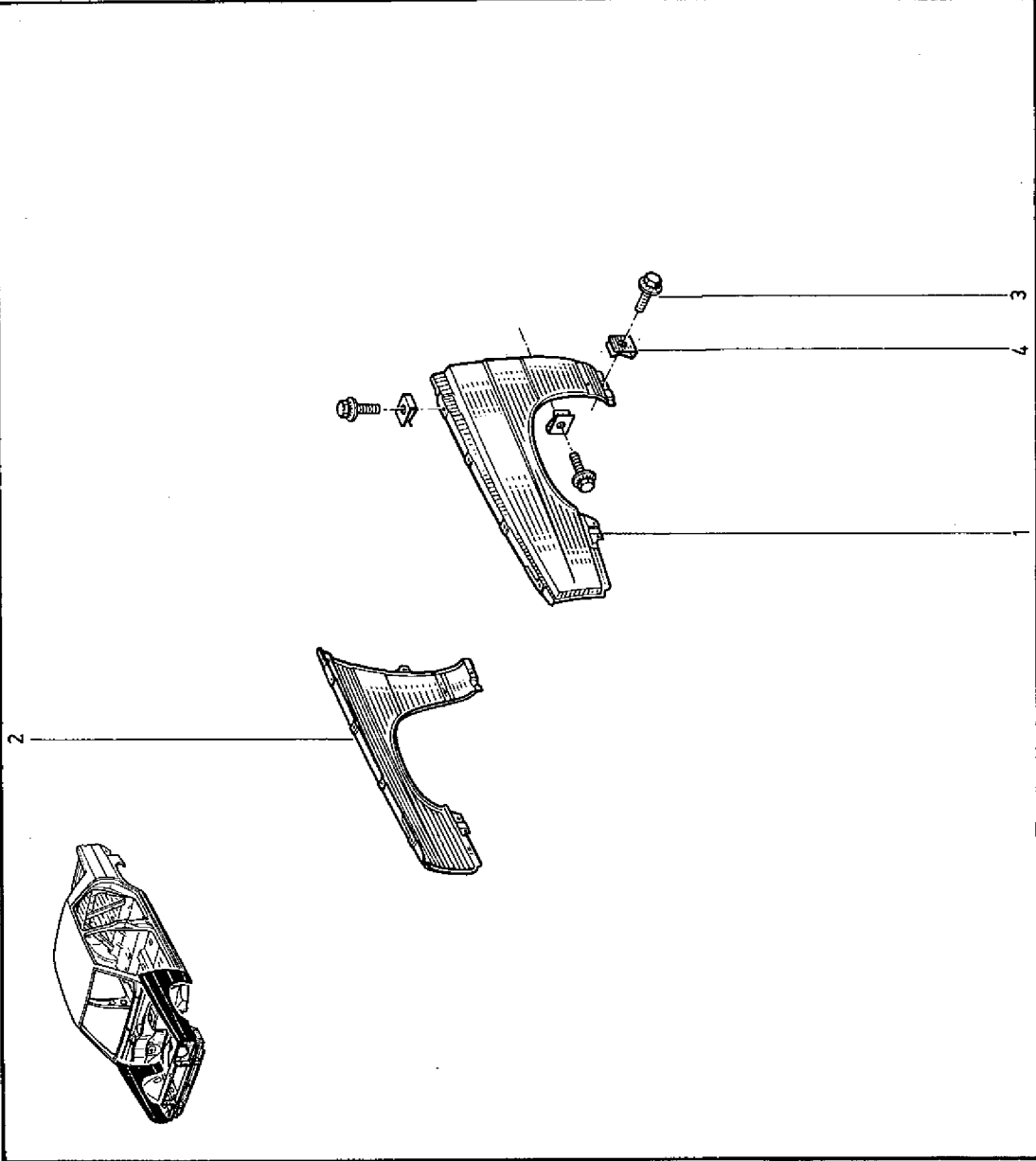

46.01
C.R.1037

- 1 - 77 00 679 013+
- 77 02 073 753
- 2 - 77 00 679 014+
- 77 02 073 754
- 3 - 77 03 016 264
- 4 - 77 03 046 049



46.10
C.R.1037

- 1 - 77 00 703 865
- 2 - 77 02 080 963
- 3 - 77 03 016 264
- 4 - 77 03 046 080
- 5 - 77 03 001 953
- 6 - 77 03 034 011
- 7 - 77 00 698 527
- 8 - 77 02 080 947
- 9 - 77 02 080 946
- 10 - 77 03 019 091 +
77 03 019 090
- 11 - 77 03 044 094
- 12 - 77 03 044 087
- 13 - 77 00 686 546
- 14 - 77 00 704 480
- 15 - 77 00 704 479
- 16 - 77 03 019 095
- 17 - 77 03 019 107
- 18 - 77 00 754 045
77 00 751 514 (B-375)
- 19 - 77 00 705 253
77 00 760 973 (B-375)
- 20 - 77 03 001 333
- 21 - 79 03 056 045
- 22 - 77 00 757 435 (B-375)
- 23 - 77 00 759 319 (B-375)
- 24 - 77 02 085 384 (B-375)

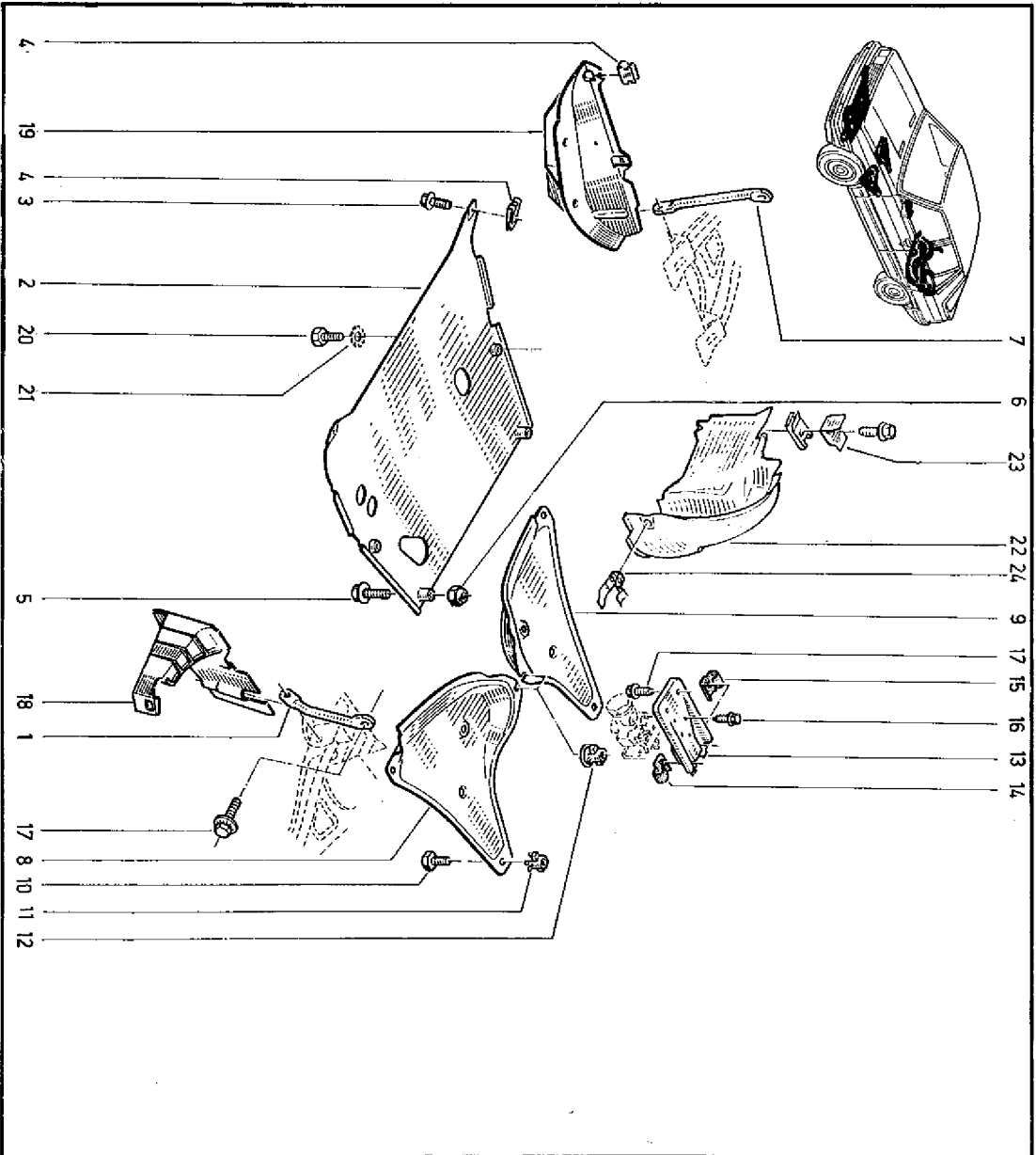

46.10
C.R.1037





47.01
C.R.1037

- 1 - 77 01 463 353 (10)
- 77 02 073 756 (10)
- 77 02 089 349 (10)
- 2 - 77 01 462 431
- 77 02 088 579
- 3 - 77 01 463 355 (12)
- 77 02 073 757 (12)
- 4 - 77 01 462 279
- 77 02 088 581
- 5 - 77 01 462 432
- 77 02 088 580
- 6 - 77 01 462 280
- 77 02 088 582
- 7 - 77 01 463 354 (10)
- 77 02 073 755 (10)
- 77 02 089 350 (10)
- 8 - 77 01 463 356 (12)
- 77 02 073 758 (12)
- 9 - 77 02 081 411
- 10 - 77 02 081 412
- 11 - 77 03 016 344
- 77 03 016 292
- 12 - 77 03 046 069
- 13 - 77 03 019 087
- 14 - 77 03 076 121



47.01
C.R.1037

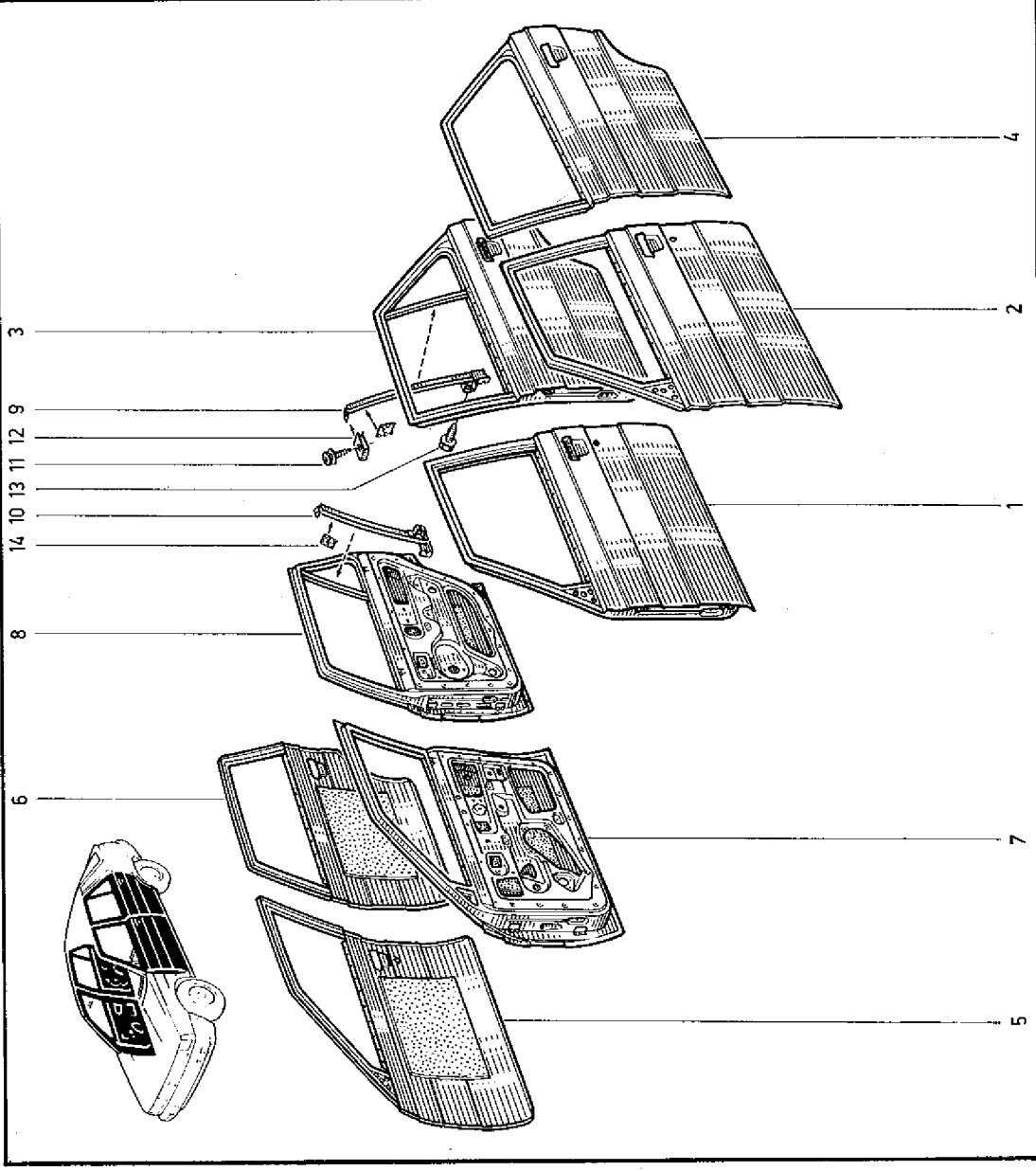

(10)	77 04 002 587-2	77 04 002 587-1
	77 00 722 443-3	77 00 722 443-1
	77 00 722 442-2	77 00 722 442-1
	77 03 005 063-4	77 03 005 065-2
		77 04 002 588-1

50.01



48.01
1089 C.R.1037

- 1 - 77 01 462 952
- 77 02 073 752
- 2 - 77 01 463 003 †
- 77 00 699 359
- 3 - 77 01 463 002 †
- 77 00 699 360
- 4 - 77 03 053 011
- 5 - 77 03 033 020
- 6 - 77 03 001 904
- 7 - 77 00 753 858
- 8 - 77 03 072 050
- 9 - 77 00 681 803
- 10 - 77 05 028 008
- 11 - 77 03 078 086
- 12 - 77 00 719 651
- 13 - 77 01 462 882
- 14 - 77 04 002 006
- 15 - 77 03 067 175
- 16 - 77 00 697 776
- 17 - 77 00 763 919
- 18 - 4000335 (x = 12,5)
4000377 (x = 24,5)

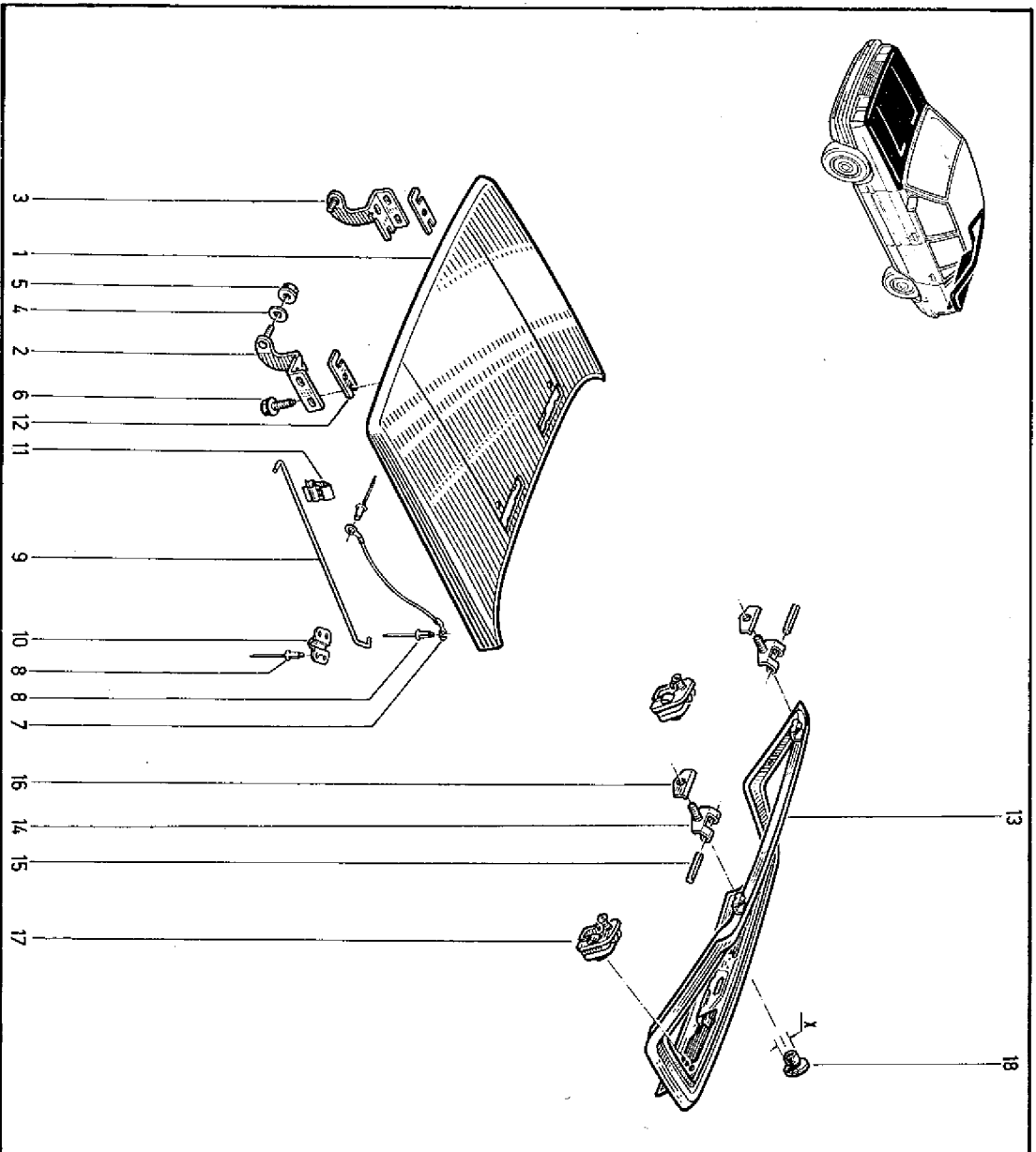

48.01
C.R.1037



50.01
C.R.1037



- 1 - 77 04 001 862 †
- 77 04 002 587
- 2 - 77 03 067 008
- 3 - 77 03 074 177
- 4 - 77 00 685 303
- 77 01 349 555 †
- 77 00 771 925 †
- 5 - 77 03 037 002
- 6 - 77 03 067 093
- 7 - 77 04 001 863 †
- 77 04 002 588
- 8 - 77 00 722 442
- 9 - 77 03 005 065
- 10 - 77 00 722 443

50.01
C.R.1037

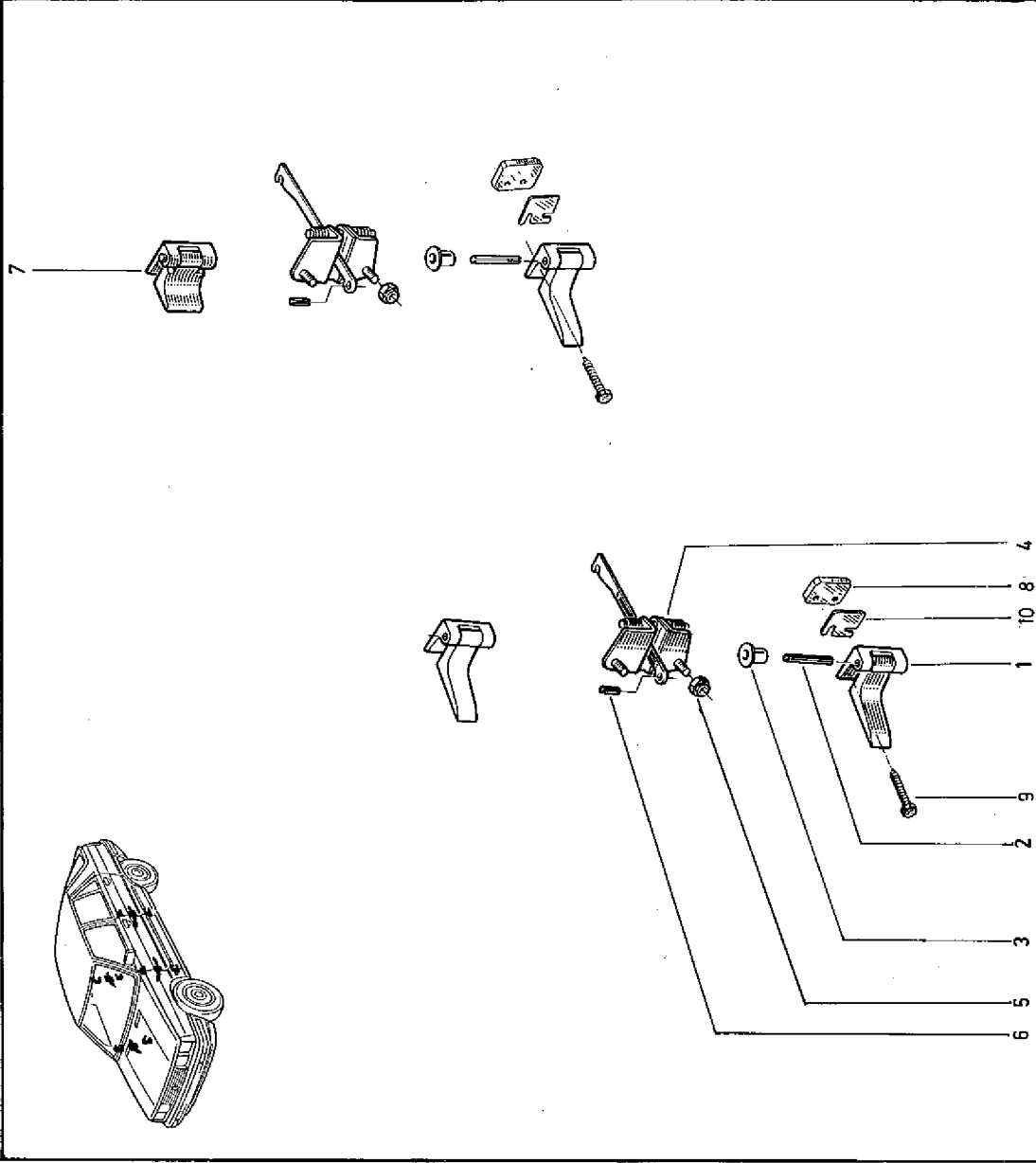

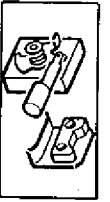

50.10
C.R.1037

- 1 - 77 01 348 165 +
- 77 00 639 889
- 2 - 77 03 004 082
- 3 - 77 00 757 791
- 4 - 77 01 029 254
- 5 - 77 01 018 447
- 6 - 77 01 029 257
- 7 - 77 01 348 167 +
- 77 00 587 338
- 8 - 77 01 348 166 +
- 77 00 639 888
- 9 - 77 00 757 792
- 10 - 77 01 029 253 +
- 11 - 77 01 348 168 +
- 77 00 587 337
- 12 - 77 01 029 258

↔ B372

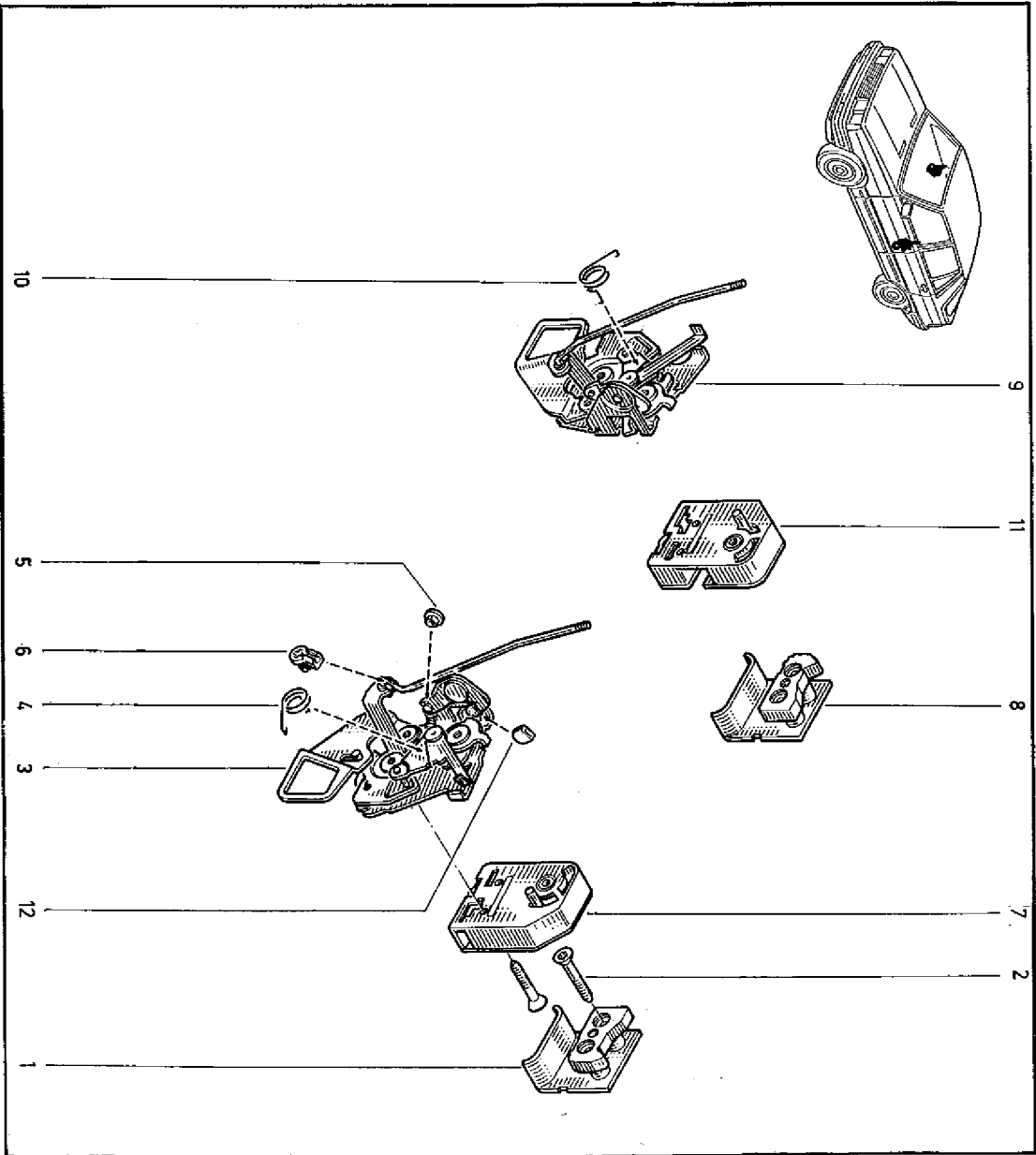

50.10
C.R.1037





50.15
C.R.1037

- 1 - 77 01 348 165 †
- 2 - 77 00 639 889
- 3 - 77 03 004 082
- 4 - 77 01 348 167 †
- 5 - 77 00 587 388
- 6 - 77 01 029 288
- 7 - 77 01 023 144
- 8 - 77 01 029 285
- 9 - 77 01 023 206
- 10 - 77 01 021 253
- 11 - 77 01 023 199
- 12 - 77 01 023 200
- 13 - 77 01 029 259
- 14 - 77 01 029 260
- 15 - 77 01 348 166 †
- 16 - 77 00 639 888
- 17 - 77 01 348 168 †
- 77 00 587 337
- 77 01 029 289
- 77 01 023 207
- 77 01 021 252

B373

50.15
C.R.1037

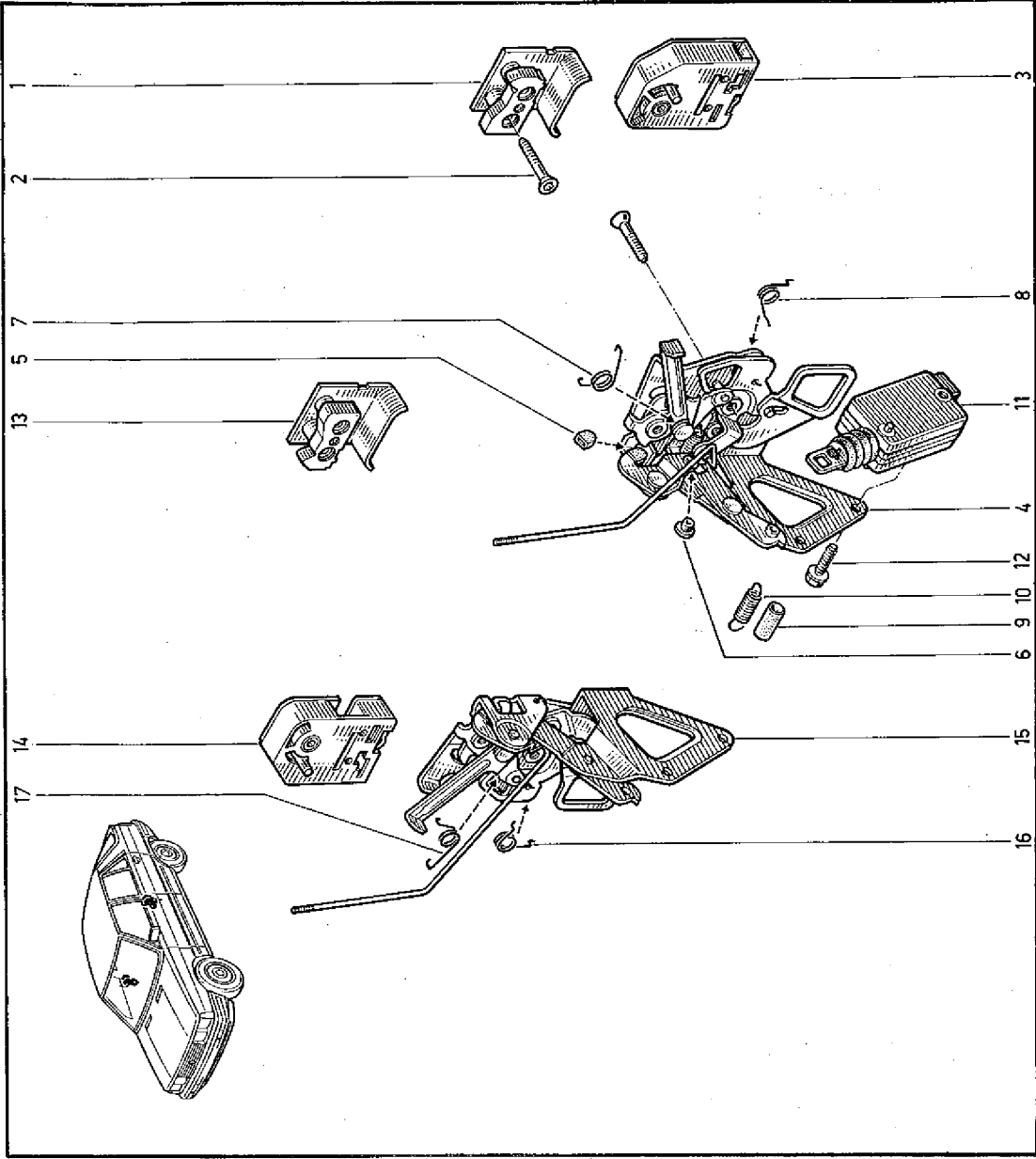

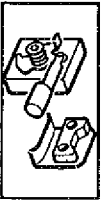

50.20
C.R.1037

- 1 - 77 01 348 165 +
- 77 00 639 889
- 2 - 77 03 004 082
- 3 - 77 00 757 789
- 77 08 710 648
- 4 - 77 01 029 254
- 5 - 77 01 018 447
- 6 - 77 01 029 258
- 7 - 77 01 348 167 +
- 77 00 587 338
- 8 - 77 01 348 166 +
- 77 00 639 888
- 9 - 77 00 757 790
- 77 08 710 649
- 10 - 77 01 029 253
- 11 - 77 01 348 168 +
- 77 00 587 337

↔ B372

50.20
C.R.1037

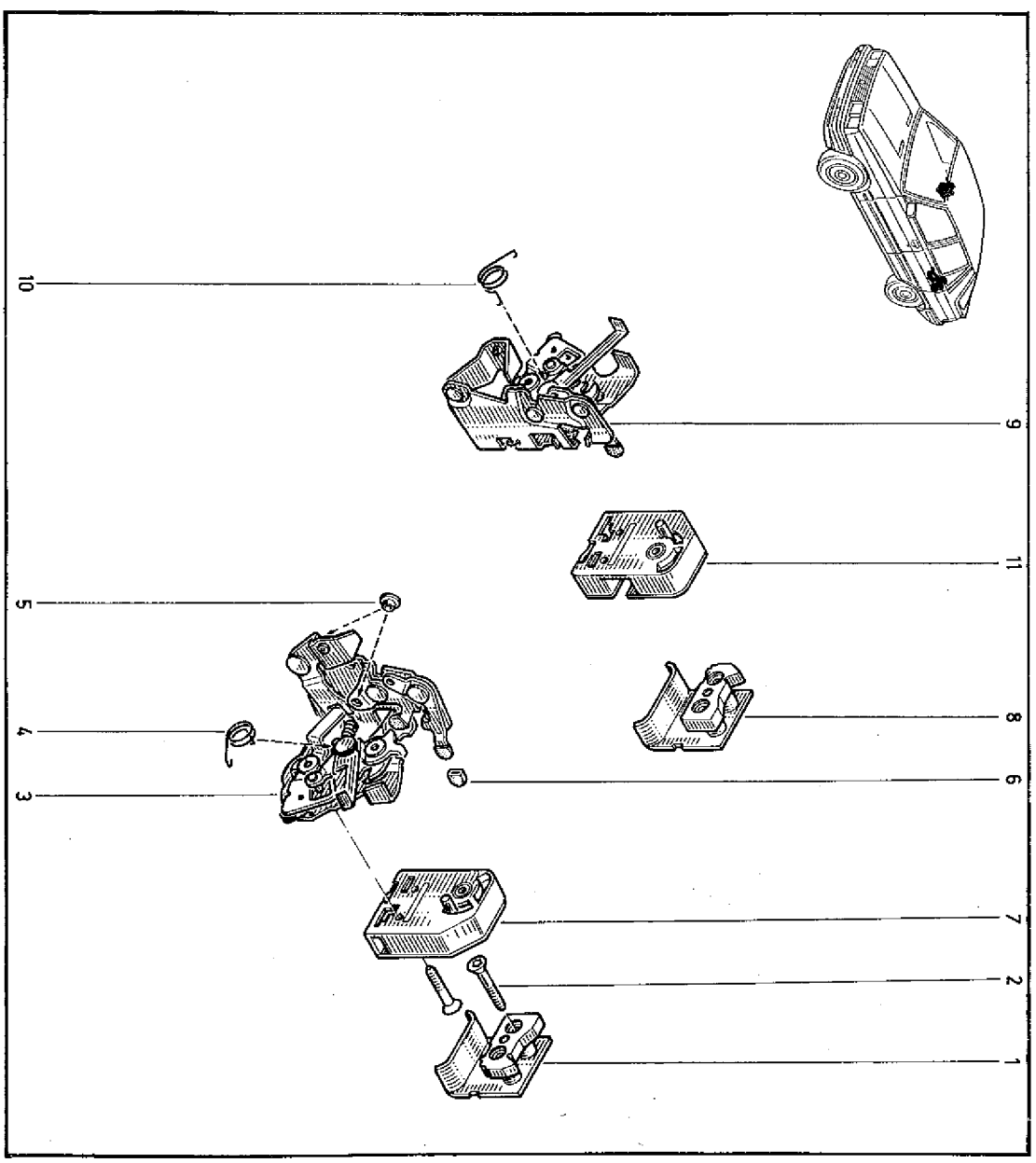



50.25
C.R.1037

B373



50.25
C.R.1037

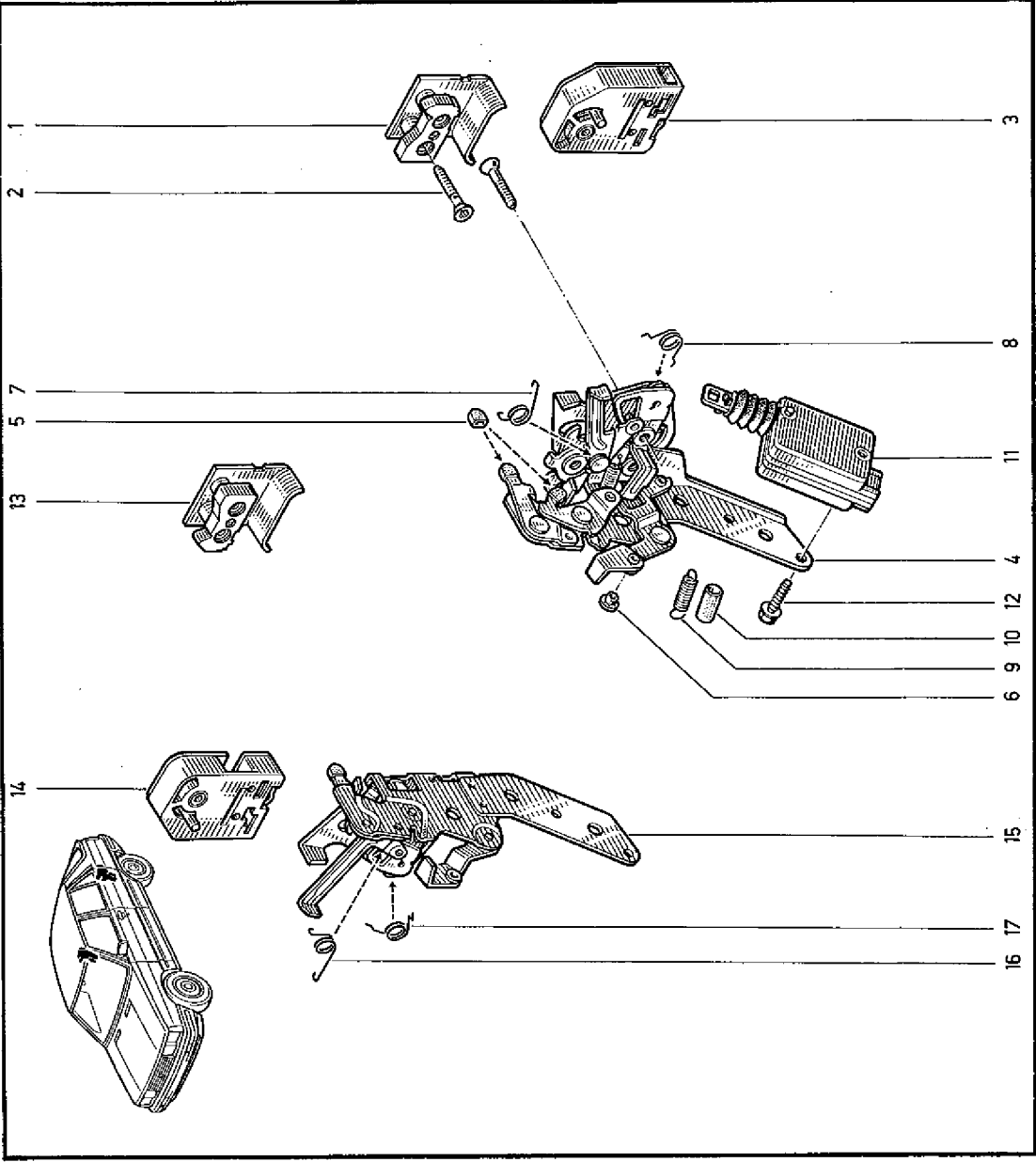

- 1 - 77 01 348 165 †
- 2 - 77 00 639 889
- 3 - 77 03 004 082
- 4 - 77 00 756 702 †
- 5 - 77 00 587 338
- 6 - 77 01 029 290
- 7 - 77 01 023 144
- 8 - 77 01 029 285
- 9 - 77 01 023 206
- 10 - 77 01 021 253
- 11 - 77 01 023 199
- 12 - 77 01 023 200
- 13 - 77 01 029 259
- 14 - 77 01 029 260
- 15 - 77 01 348 166 †
- 16 - 77 00 639 888
- 17 - 77 00 756 701 †
- 18 - 77 00 587 337
- 19 - 77 01 029 291
- 20 - 77 01 023 207
- 21 - 77 01 021 252

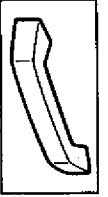

- 1 - 77 04 003 708
- 2 - 77 03 016 030
- 3 - 77 00 885 863
- 4 - 77 00 885 864
- 5 - 77 04 003 708

50.30
C.R.1037

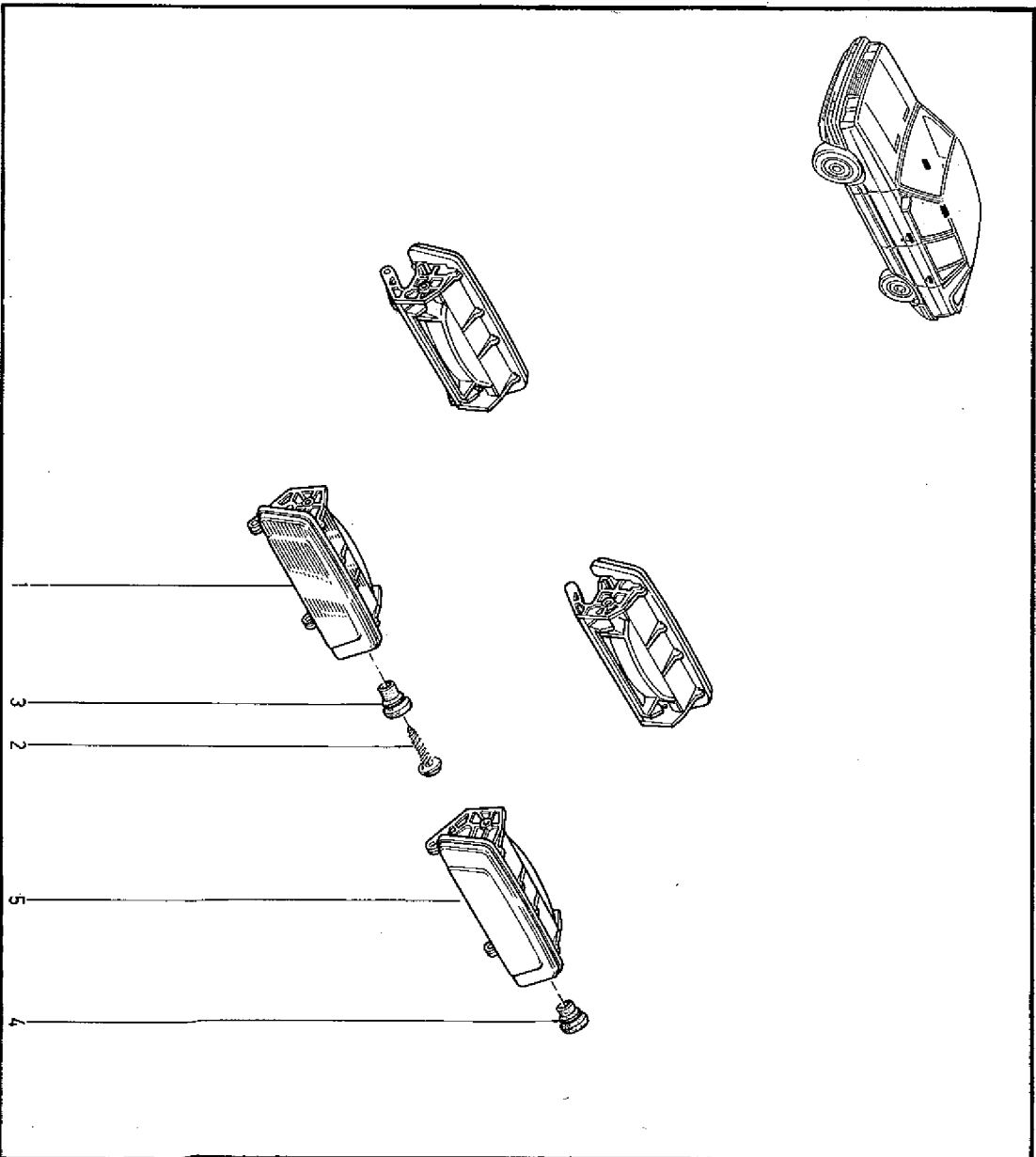

50.30
C.R.1037

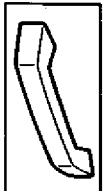



50.40
C.R.1037

- 1 - 77 00 655 167 (c)
- 2 - 77 02 081 425 (d)
- 3 - 77 03 044 008
- 4 - 77 00 714 379
- 5 - 77 03 079 214 †
- 6 - 77 03 079 290
- 7 - 77 00 711 584 (x = 46) (a)
- 8 - 77 00 711 585 (x = 64) (b)
- 9 - 77 00 711 583 (a)
- 10 - 77 00 714 012 (b)
- 11 - 77 00 655 168 (c)
- 12 - 77 02 081 424 (d)

(a) / B.372
(b) / B.373

B372	1	↑	n°
B373	1	↑	n° 28656
B375	1	↑	n° 00685
B37E	1	↑	n° 03145
B37G	1	↑	n° 05875



50.40
C.R.1037

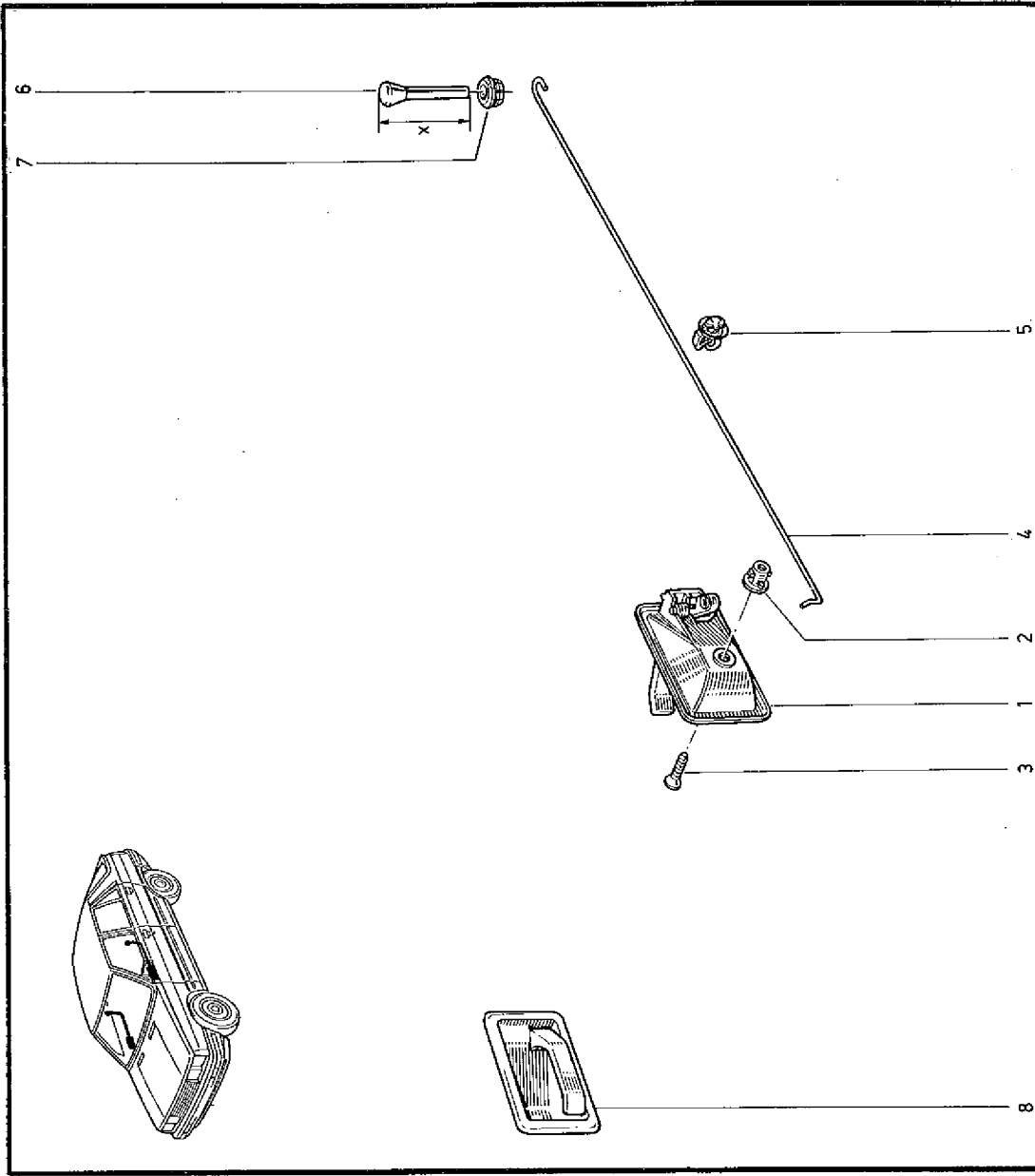

B373	1	↑	n° 28657
B375	1	↑	n° 00686
B37E	1	↑	n° 03146
B37G	1	↑	n° 05876

(d)



50.50
C.R.1037

- 1 - 77 00 655 167 (c)
- 77 02 081 425 (d)
- 2 - 77 03 044 008
- 3 - 77 03 004 109
- 4 - 77 00 714 380
- 5 - 77 03 079 214 +
- 77 03 079 290
- 6 - 77 04 002 067
- 7 - 77 00 714 383
- 8 - 77 00 711 584 (x = 46) (a)
- 77 00 711 585 (x = 64) (b)
- 9 - 77 00 711 583 (a)
- 77 00 714 012 (b)
- 10 - 77 00 655 168 (c)
- 77 02 081 424 (d)
- 11 - 77 04 002 068
- 12 - 77 03 079 118
- 13 - 77 00 571 998

(a) / B372- B376
(b) / B373- B37E

B372	1	→	n°
B373	1	→	n° 28656
B375	1	→	n° 00685
B37E	1	→	n° 03145
B37G	1	→	n° 05875

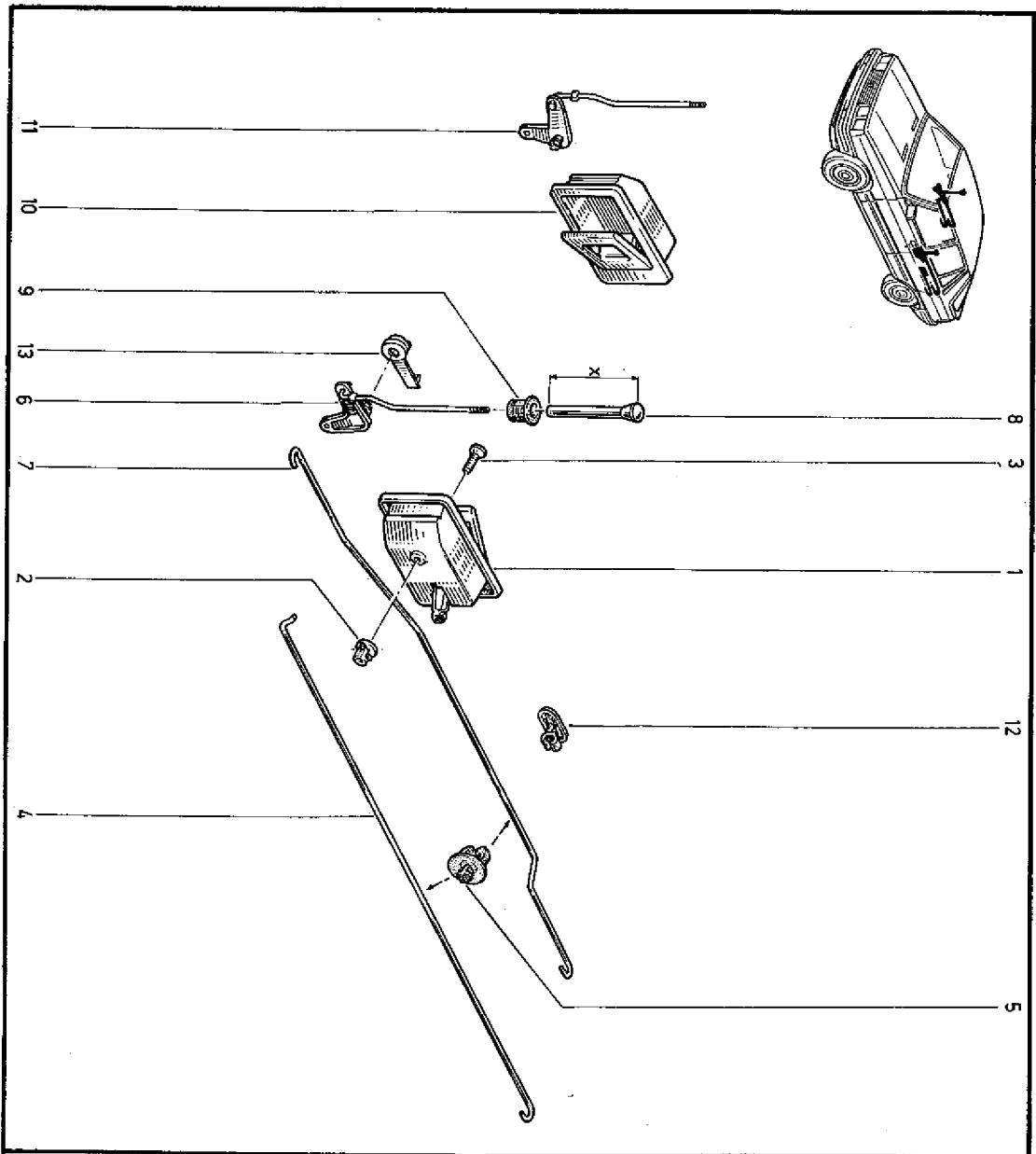

50.50
C.R.1037



B373	1	→	n° 28657
B375	1	→	n° 00686
B37E	1	→	n° 03146
B37G	1	→	n° 05876

(d)



50.54
C.R.1037

- 1 - 77 01 349 575
- 2 - 77 00 696 836
- 3 - 77 04 000 794
- 4 - 79 03 056 008
- 5 - 77 03 101 006
- 6 - 79 03 032 009
- 7 - 77 01 027 608
- 8 - 77 01 349 576
- 9 - 77 01 027 609
- 10 - 77 03 078 077



50.54
C.R.1037

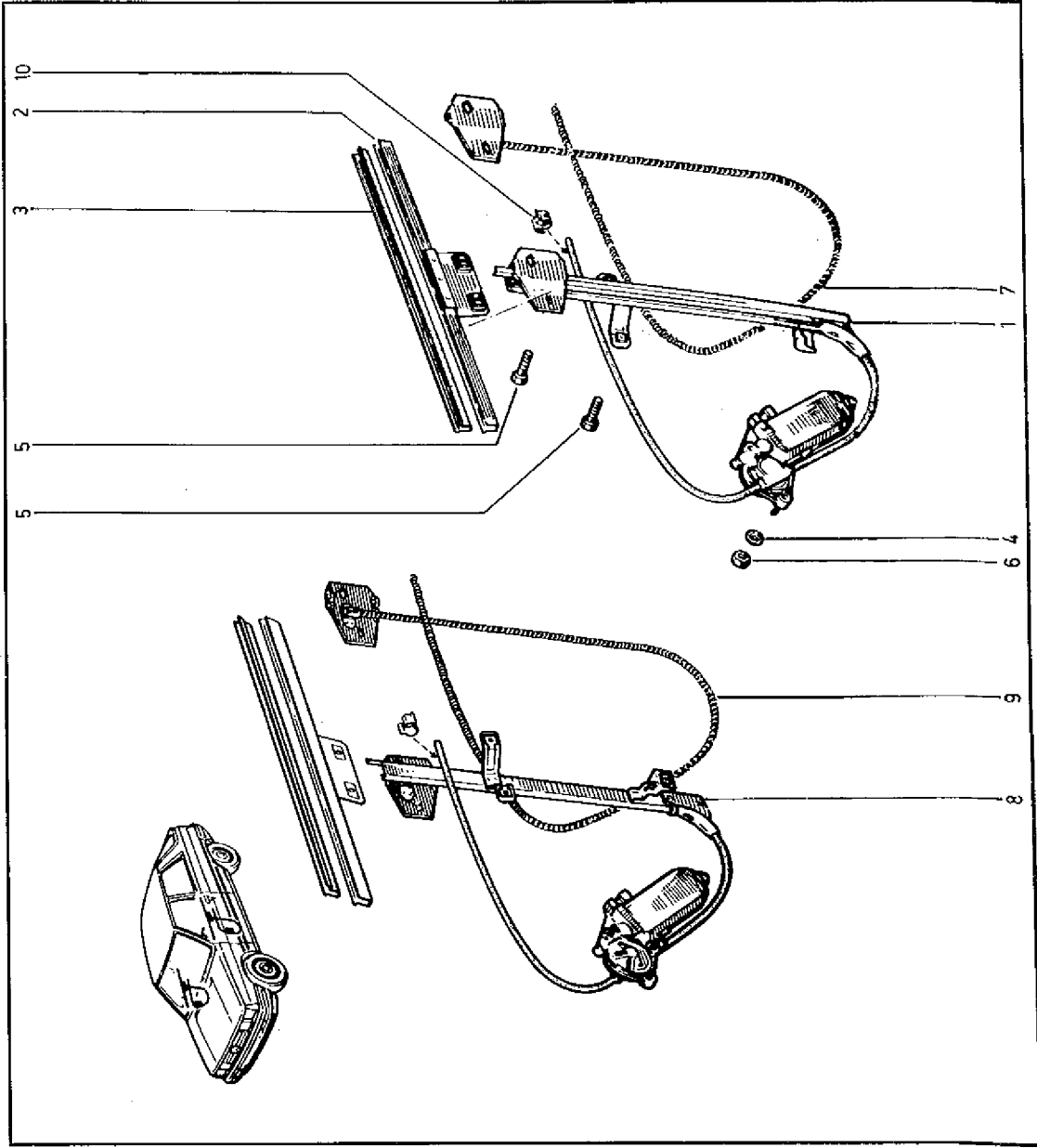

B373 n°04834 □ n°....

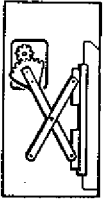

50.55
CR1037

- 1 - 77 01 349 510
- 2 - 77 00 696 836
- 3 - 77 04 001 746
- 77 04 000 794
- 4 - 77 03 101 006
- 5 - 77 04 001 313
- 6 - 77 04 001 315
- 7 - 77 01 349 511
- 8 - 77 03 078 077

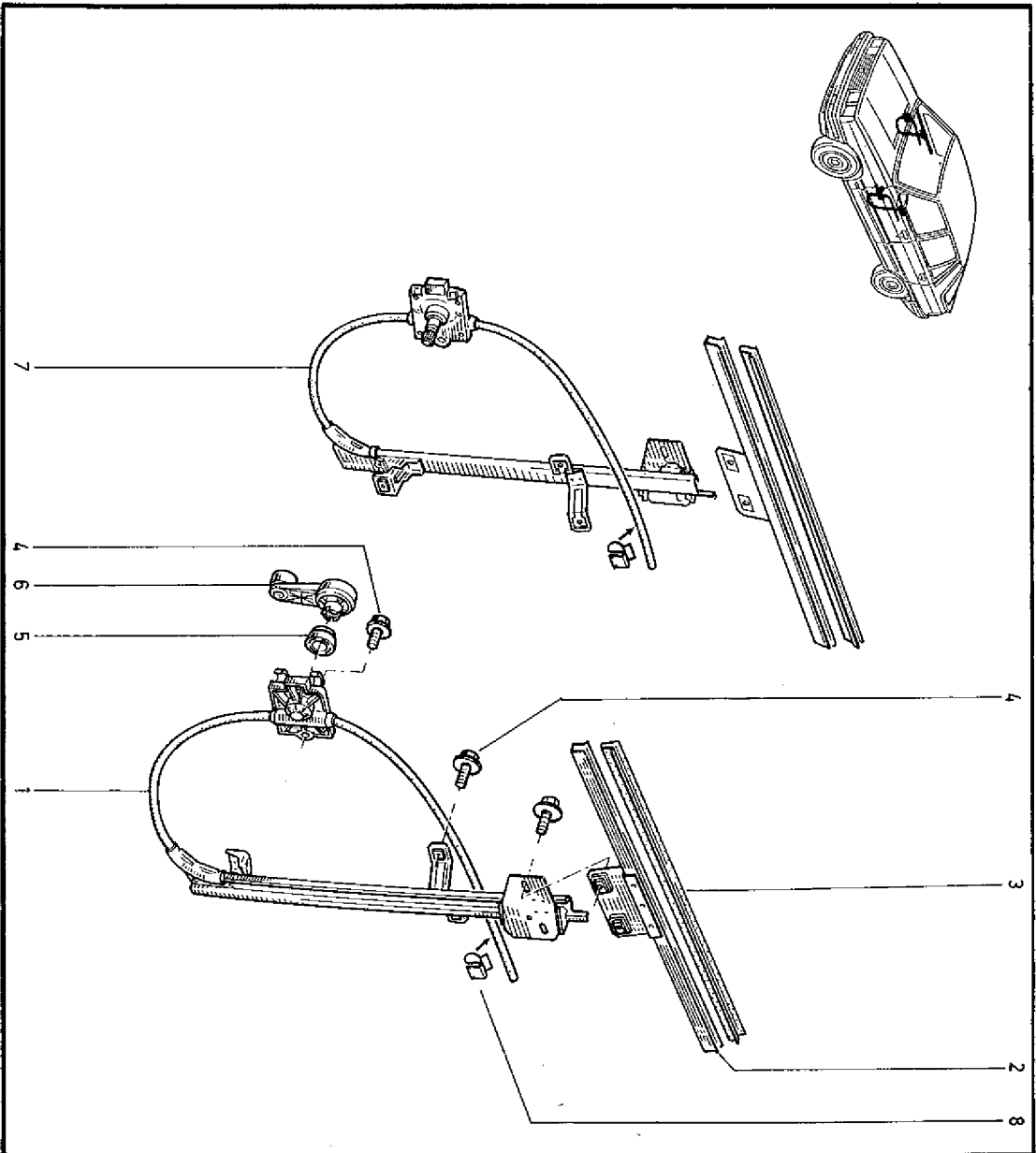

50.55
CR1037

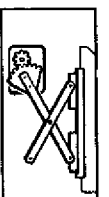

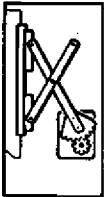

50.60
A C.R.1037

- 1 - 77 02 081 564
- 2 - 77 02 081 619
- 3 - 77 02 081 620
- 4 - 77 02 081 618
- 5 - 79 03 056 008
- 6 - 79 03 032 009
- 7 - 77 00 636 758
- 8 - 77 04 000 794
- 9 - 77 02 081 572
- 10 - 77 02 081 565



50.60
A C.R.1037

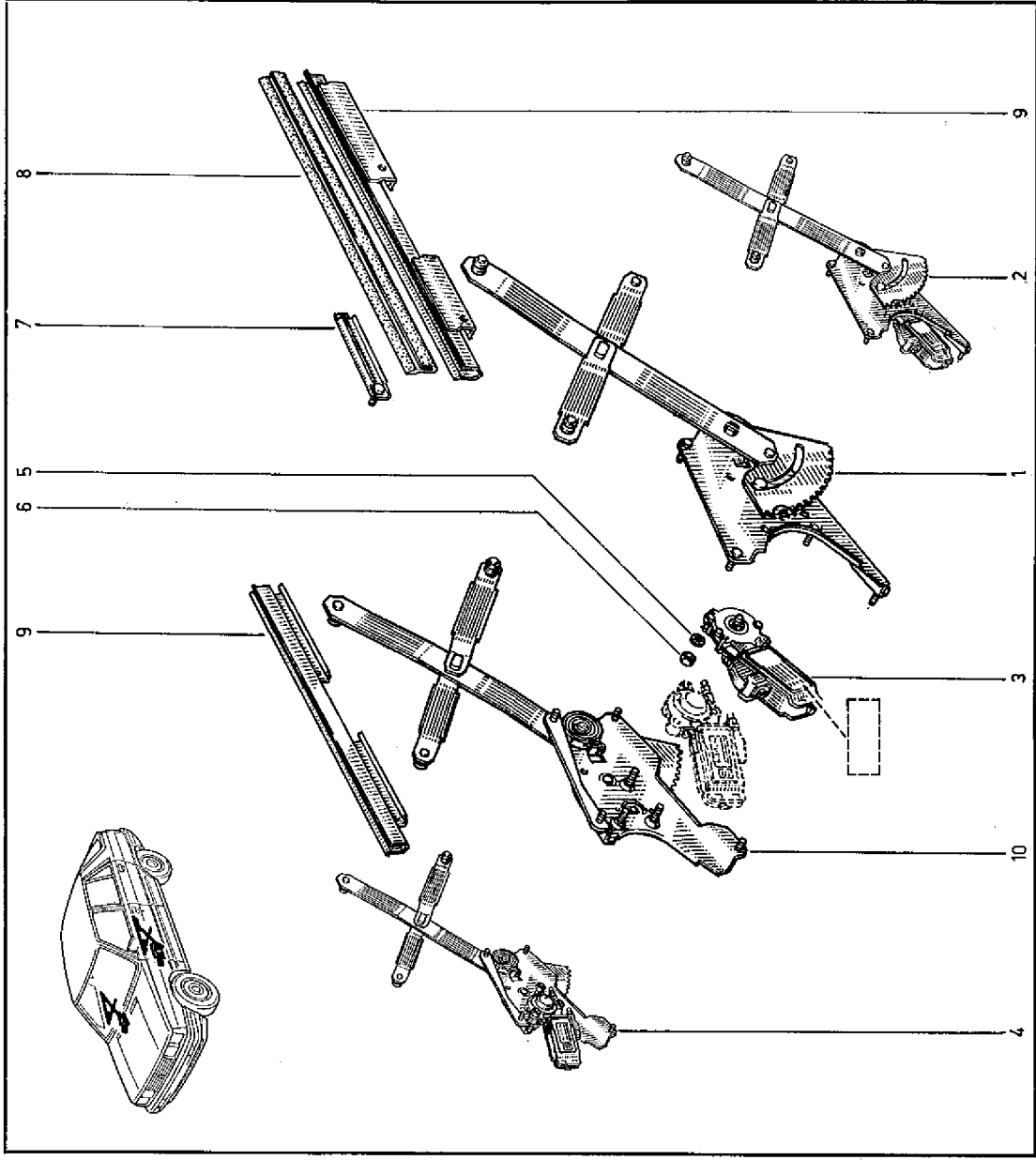
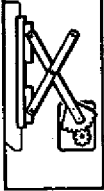

B.373 n° 12851 n°

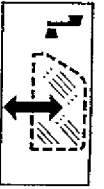

50.65
C.R.1037

- 1-77 02 081 562
- 2-77 02 081 563
- 3-79 03 037 001
- 4-77 00 636 758
- 5-77 02 081 572
- 6-77 04 000 794
- 7-77 04 001 313
- 8-77 04 001 315
- 9-77 03 076 107

B37G n° 05594 → n°

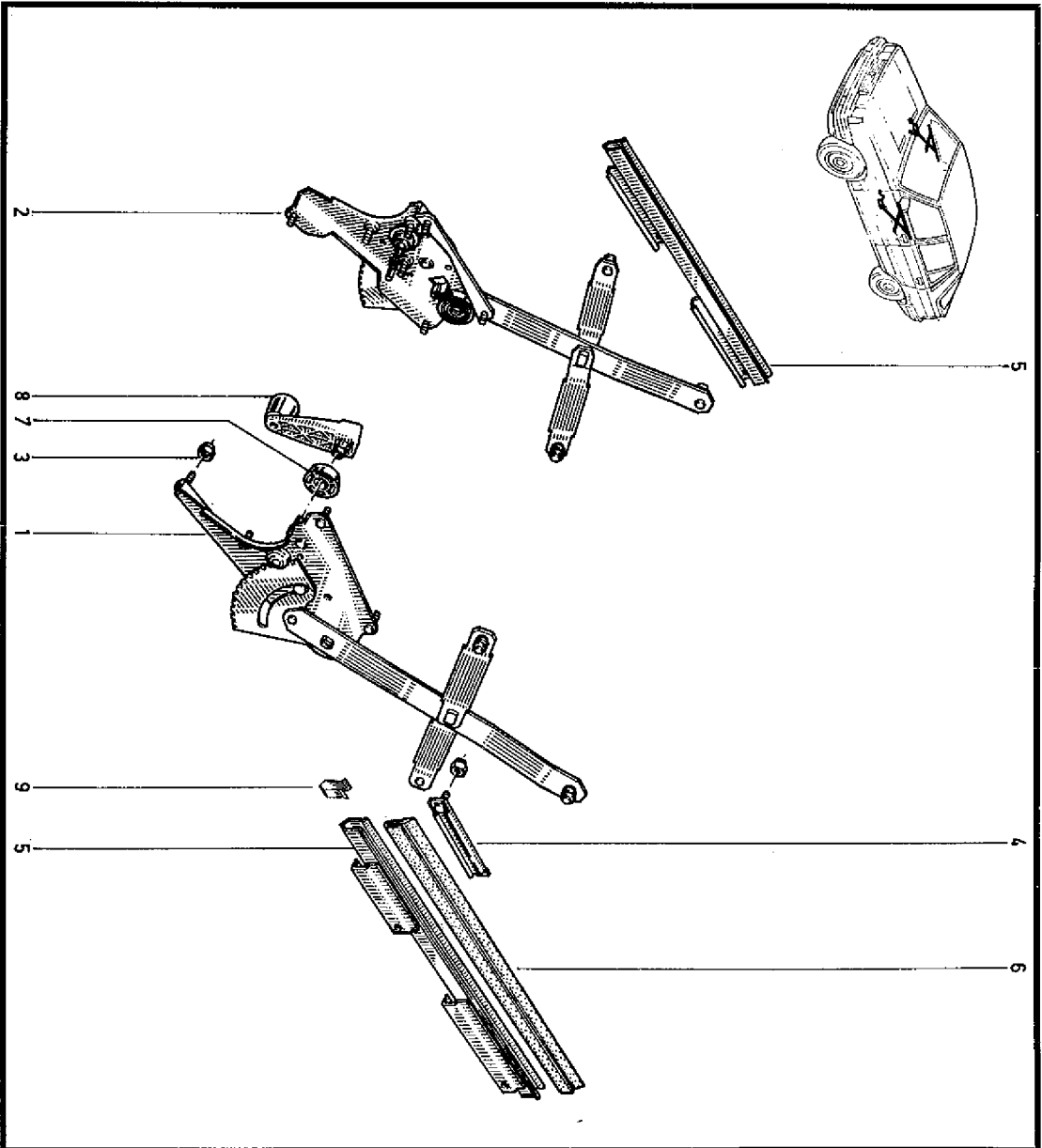

50.65
C.R.1037

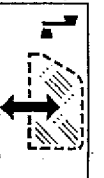

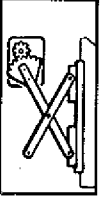

50.70
C.R.1037

- 1 - 77 00 757 189 +
77 08 694 716
- 2 - 79 03 056 027
- 3 - 79 03 032 010
- 4 - 77 02 108 809
- 5 - 77 04 000 795
- 6 - 77 04 001 218 288
- 77 04 001 313 311
- 7 - 77 04 001 207 288
- 77 04 001 315 311
- 8 - 77 00 757 190
77 08 694 717 +
- 9 - 77 03 076 107

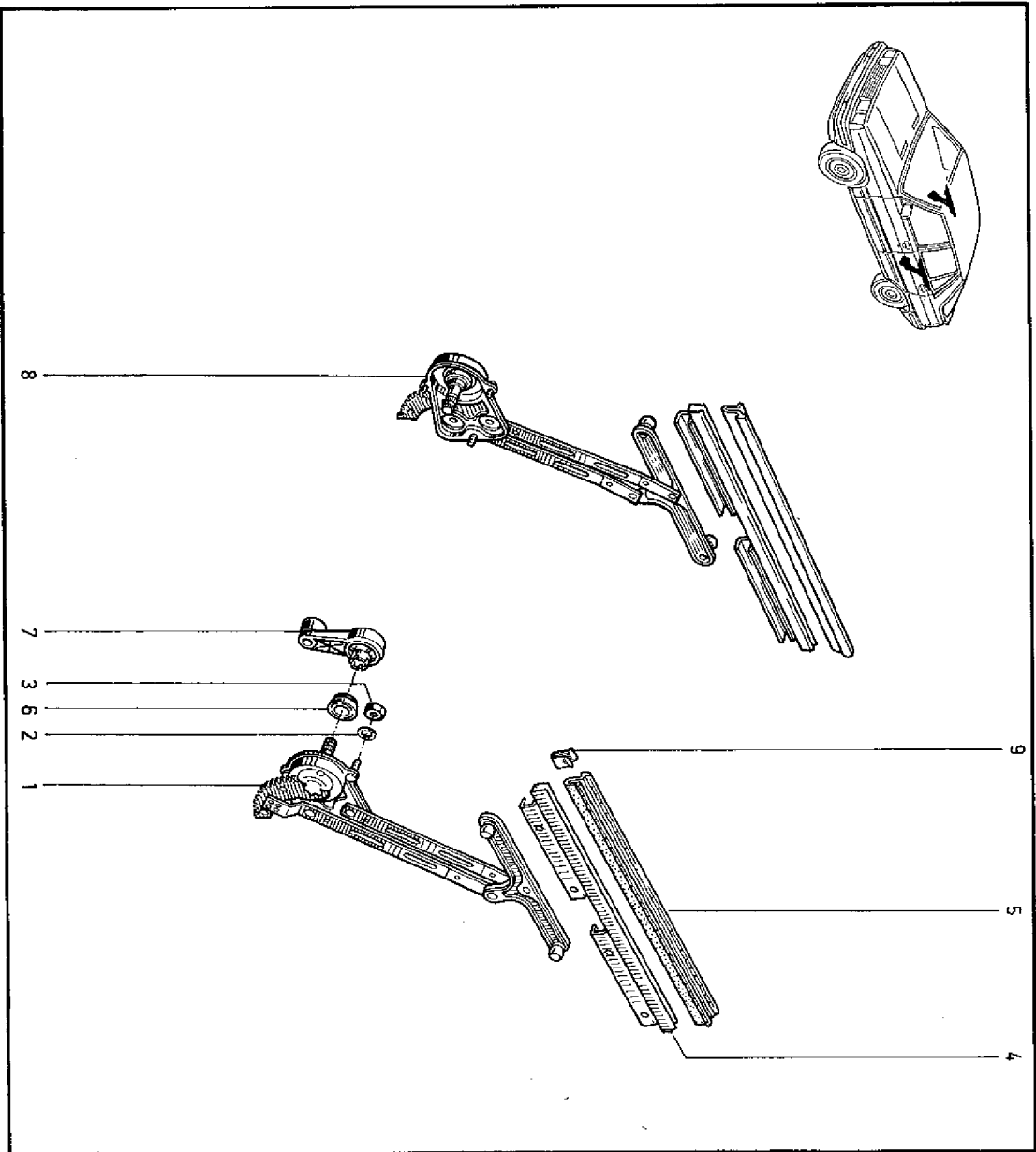

50.70
C.R.1037



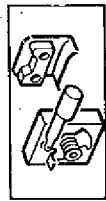

52.01
C.R. 1037

- 1 - 77 02 081 410
- 2 - 77 03 044 087
- 3 - 77 03 007 086
- 4 - 77 01 349 457 †
- 5 - 77 00 679 937
- 6 - 77 03 019 089
- 6 - 77 03 078 084

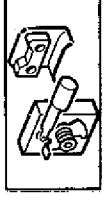

52.01
C.R. 1037

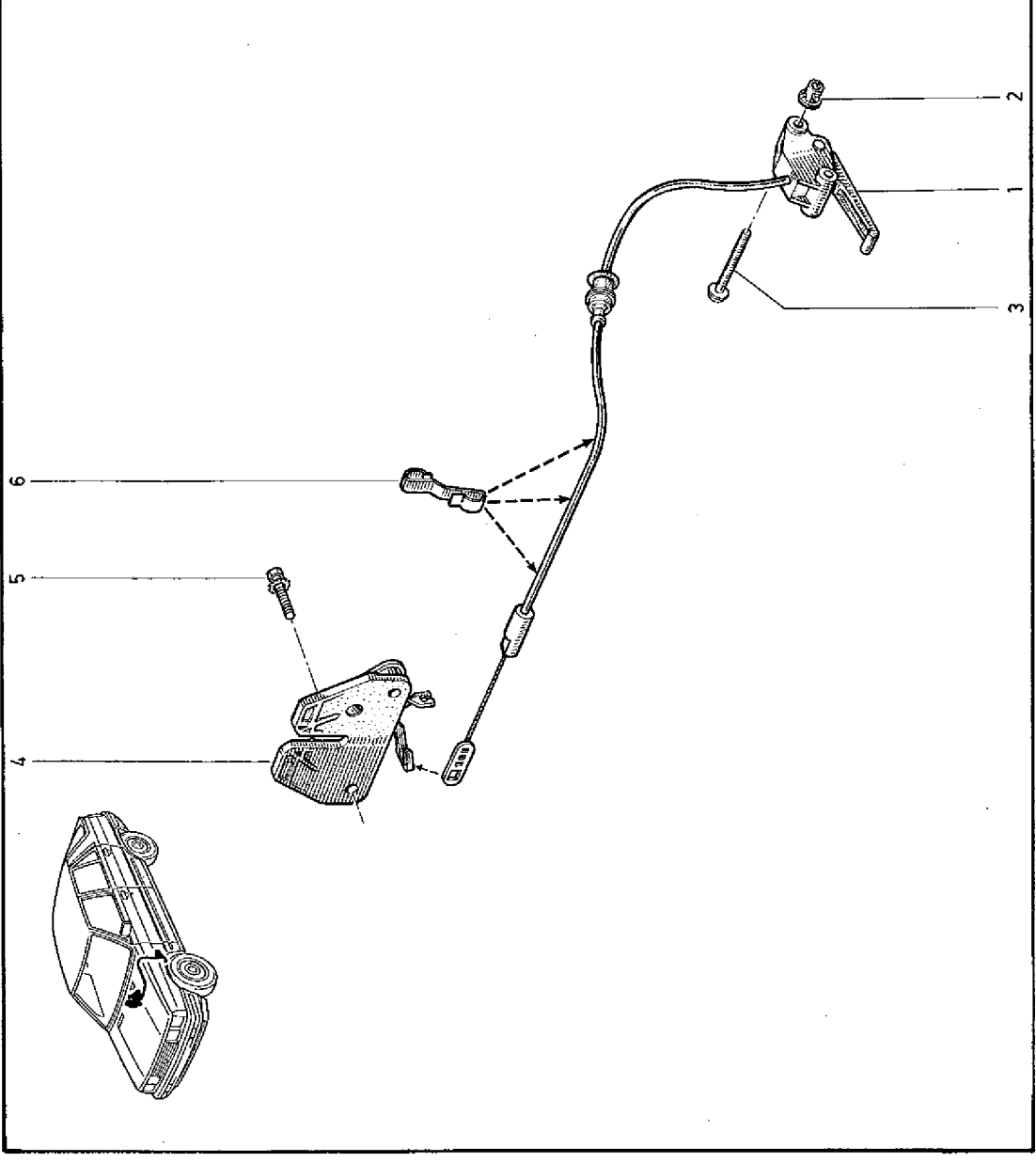



52.20
C.R.1037

- 1 - 77 00 758 714+
- 77 02 081 683
- 77 00 758 712+
- 2 - 77 01 349 568
- 3 - 77 03 019 087
- 4 - 77 03 053 407
- 5 - 77 00 712 549
- 6 - 77 00 712 548
- 7 - 77 02 081 539
- 8 - 77 03 019 090
- 9 - 77 00 753 133+
- 10 - 77 00 753 309
- 11 - 77 00 754 290
- 12 - 77 00 654 941+
- 77 01 031 090

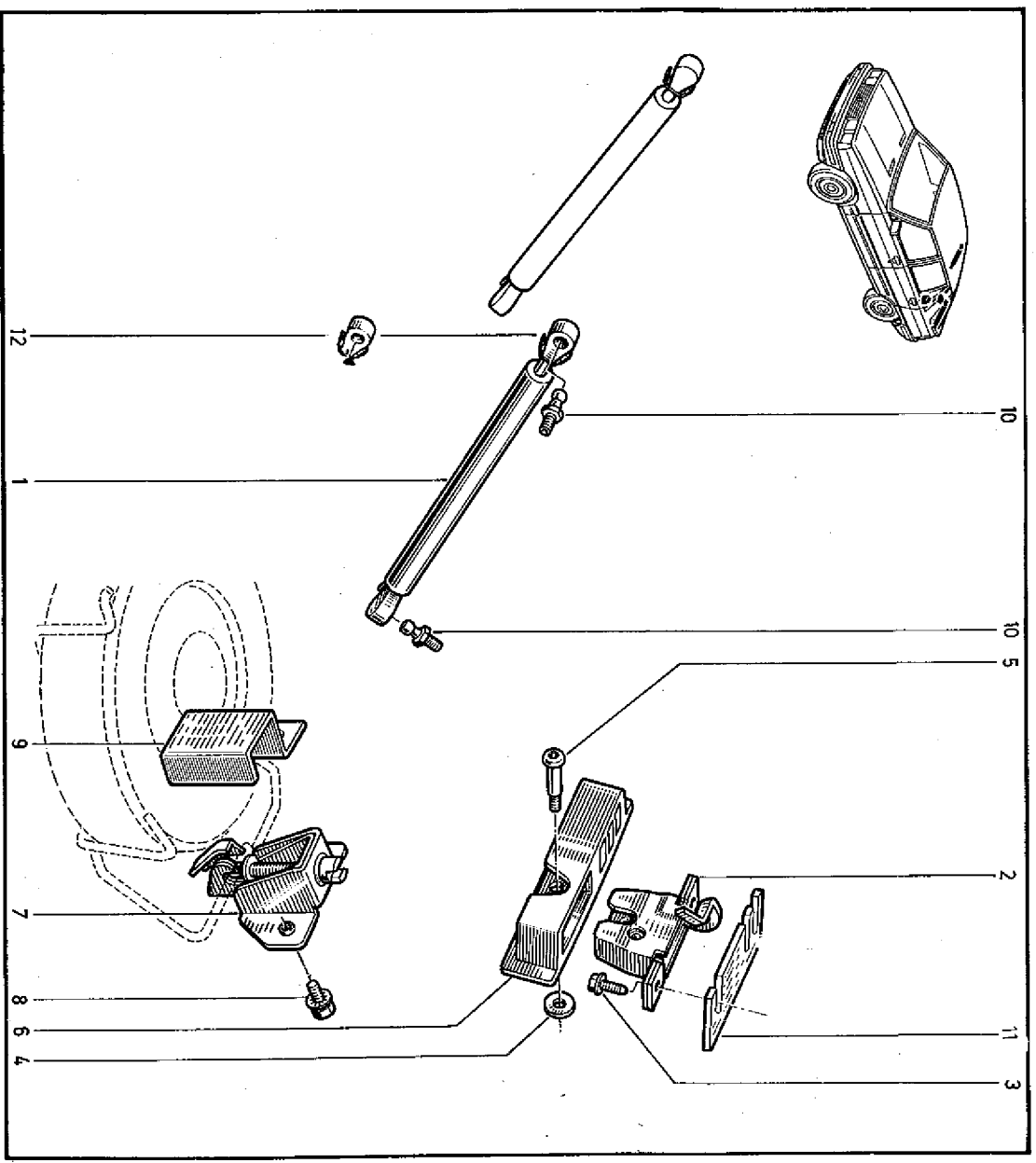

52.20
C.R.1037



53.01
C.R. 1037

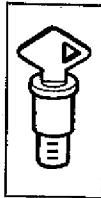

- 1 - 77 01 349 704 †
- 77 00 754 144
- 2 - 77 01 349 637 †
- 77 01 029 484
- 3 - 77 00 704 136
- 4 - 77 00 653 447 (a) ◀▶
- 5 - 77 03 067 257 (a) ◀▶
- 6 - 77 01 029 211
- 7 - 77 00 703 348
- 8 - 77 01 349 507 †
- 77 01 349 789 †
- 77 01 028 420
- 9 - 77 01 349 462 (b) ▶
- 10 - 77 01 349 463 (b) ▶
- 11 - 77 00 769 760 (S-375)

(a) / B372-B37G
(b) / B373-B37E-B37T

53.01
C.R. 1037

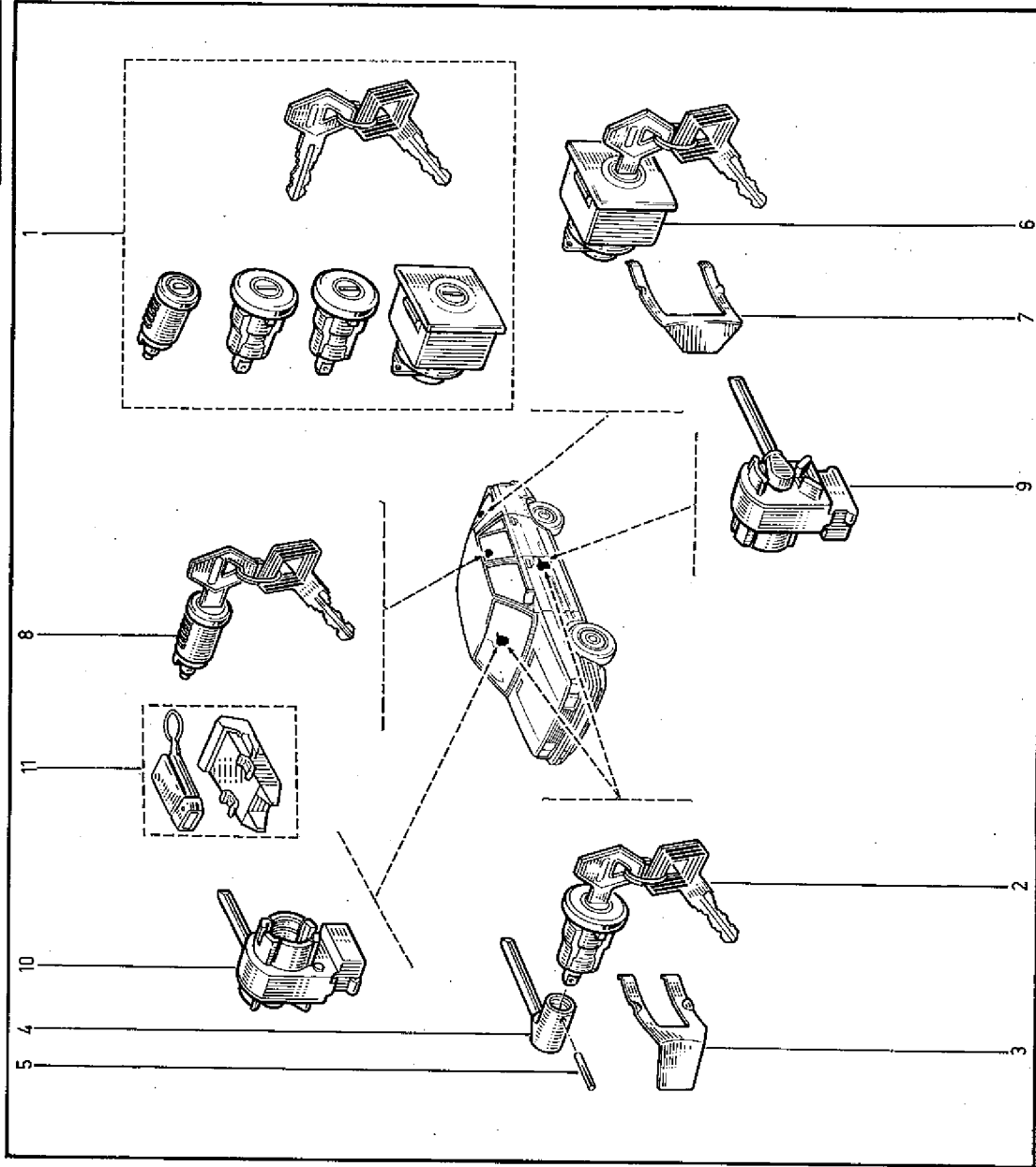
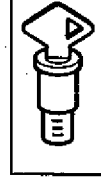



54.01
C.R.1037

- 1 - 77 04 000 621 (F) (B-375)
77 04 000 617 (T) (a)
77 04 003 394 (F) (T)
- 2 - 77 04 000 587 (T)
77 04 000 588 (F)
- 3 - 77 04 000 603 (T)
77 04 000 605 (F)
77 04 000 607 (T)
- 4 - 77 04 000 609 (F)
77 04 000 595 (T)
77 04 000 597 (F)
- 5 - 77 04 000 588 (T)
77 04 000 590 (F)
77 04 000 592 (T)
77 04 000 594 (F)
- 6 - 77 04 000 604 (T)
77 04 000 606 (F)
77 04 000 608 (T)
- 7 - 77 04 000 596 (T)
77 00 000 598 (F)
77 04 000 600 (T)
77 04 000 602 (F)
- 8 - 77 04 001 271 (T)
77 04 001 557 (F)
- 9 - 77 00 855 281
- 10 - 02 24 842 900

(a) B37E

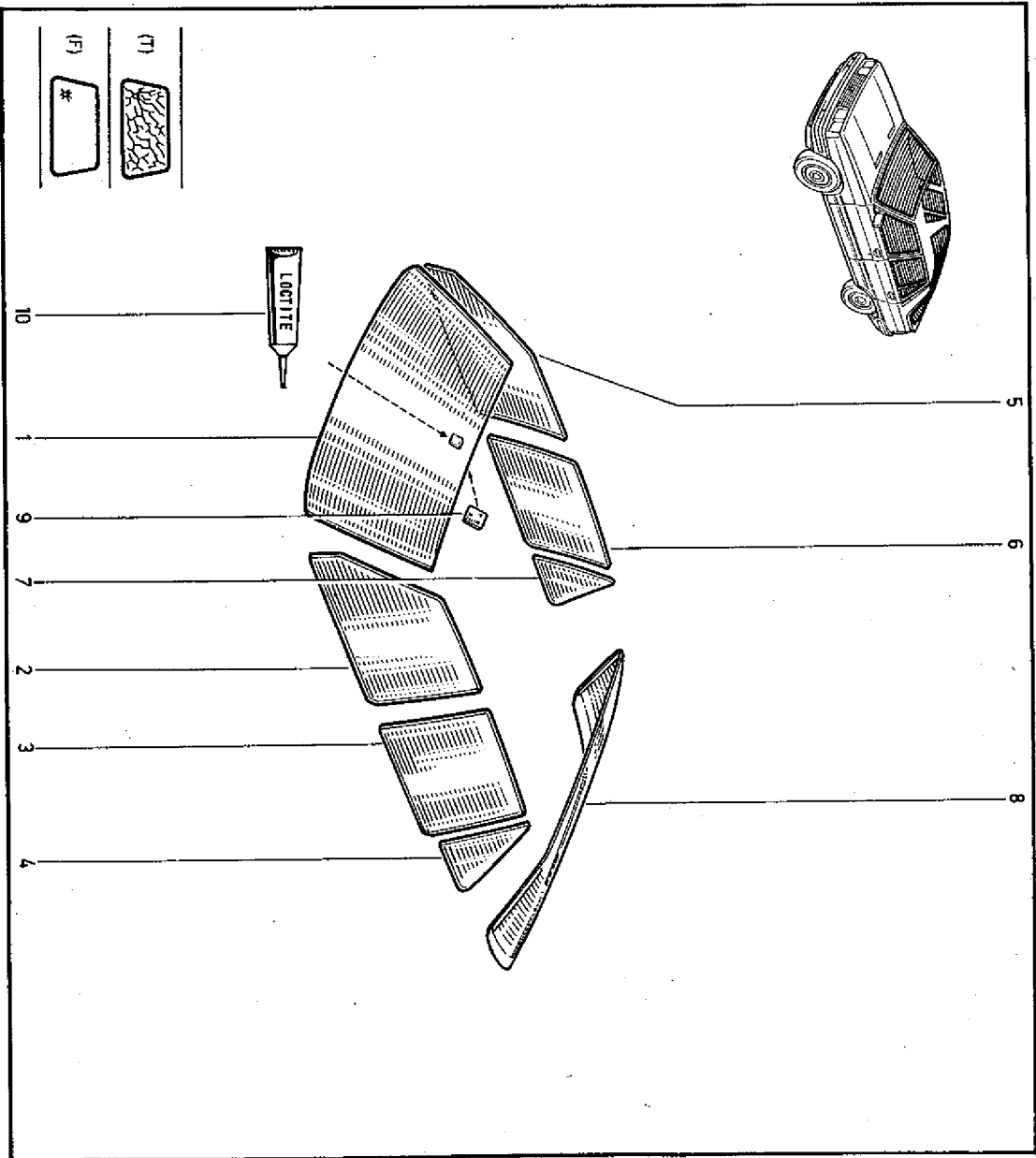

54.01
C.R.1037





55.01
C.R.1037

- 1 - 77 01 462 865† (a)
- 77 00 701 092† (a)
- 77 02 081 545 (a)
- 2 - 77 01 463 001
- 3 - 77 03 016 298
- 4 - 77 03 083 016
- 5 - 77 03 006 103
- 6 - 77 03 016 264
- 7 - 77 03 046 031
- 8 - 77 03 001 020
- 9 - 79 03 056 064
- 10 - 08 55 262 600
- 11 - 77 02 081 720 (b)
- 77 01 463 086 (b)
- 12 - 77 00 754 271 (b)
- 13 - 77 00 754 272 (b)

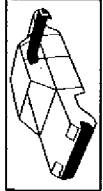

55.01
C.R.1037

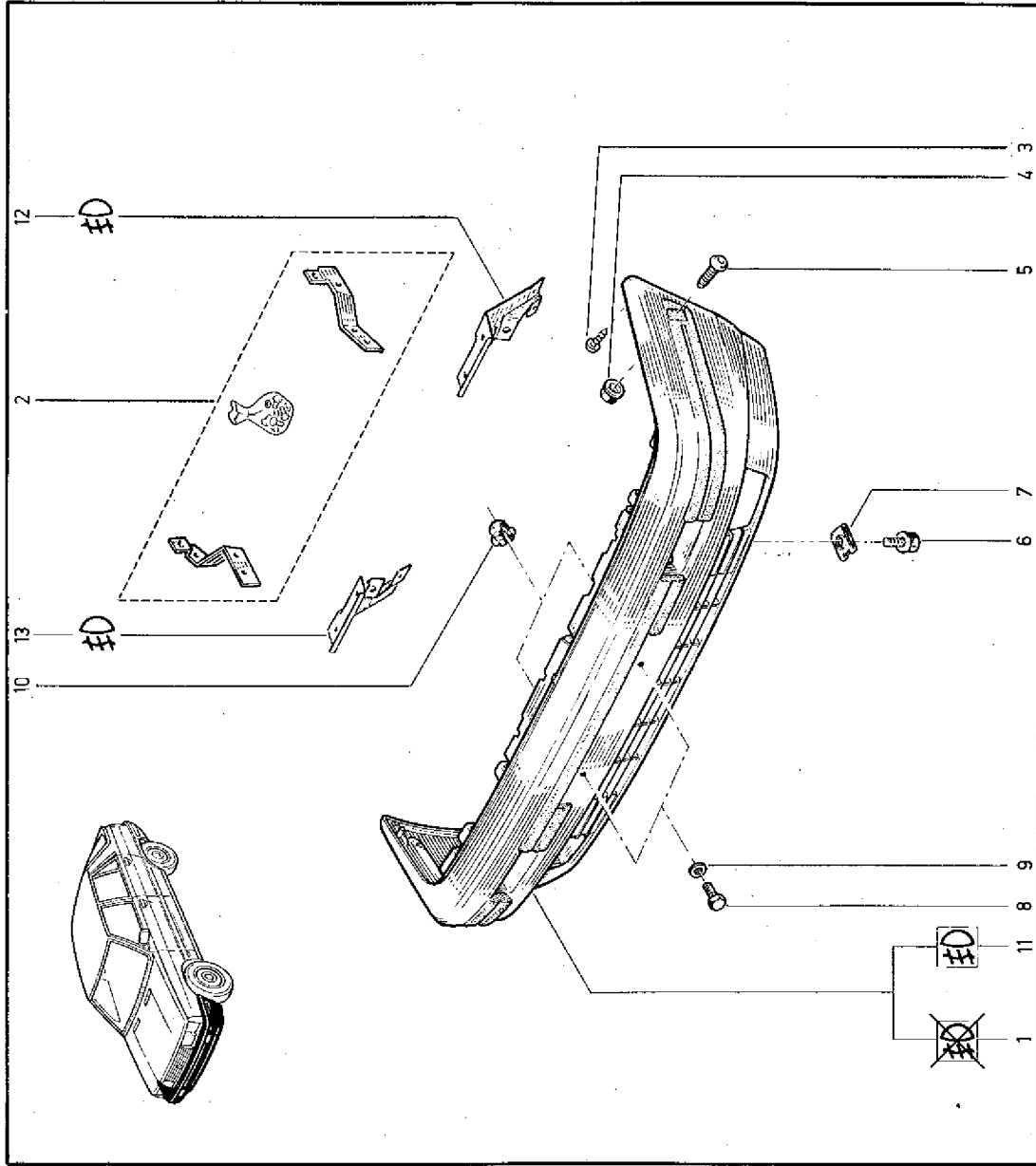

(a)	B372	n°	1	→	n°
	B373	n°	1	→	n°
	B37G	n°	1	→	n°
(b)	B37E	n°	1	→	n°
	B37T	n°	1	→	n°



55.02
C.R.1037

- 1 - 77 01 601 740 ± (20)
- 77 00 752 734
- 2 - 77 01 463 001
- 3 - 77 03 016 298
- 4 - 77 03 033 016
- 5 - 77 03 006 103
- 6 - 77 03 046 031
- 7 - 77 03 016 264
- 8 - 77 03 001 020
- 9 - 79 03 056 064
- 10 - 0855262600
- 11 - 77 00 752 364
- 12 - 77 00 752 365
- 13 - 77 04 001 983 ± (21)
- 14 - 77 04 001 870 ± (21)
- 15 - 77 04 001 982 ± (21)
- 16 - 77 00 756 455
- 17 - 77 03 074 235
- 18 - 77 01 203 085
- 19 - 77 01 203 093
- 20 - 77 00 702 828 ± (22)
- 21 - 77 00 702 829 ± (22)

B375

55.02
C.R.1037

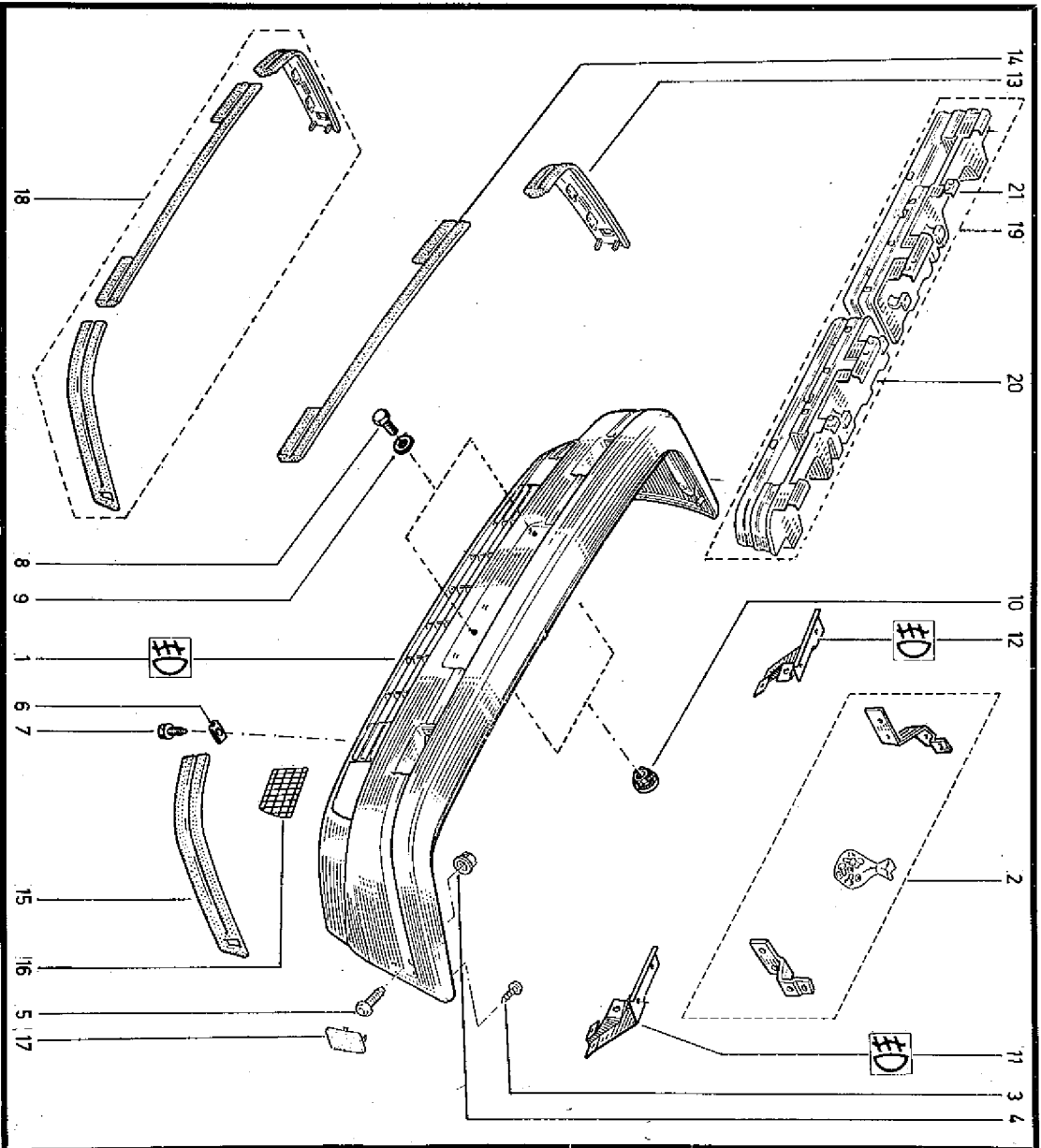

- (20) E 77 00 752 734 -1
- 77 01 203 085 -1
- 77 01 203 093 -1
- (21) E 77 01 203 085 -1
- (22) E 77 01 203 093 -1

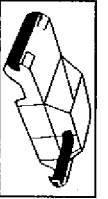

55.10
C.R.1037

- 1 - 77 01 613 348 +
- 77 02 081 529 (a)
- 77 01 613 345 (B-375) +
- 77 00 698 645 (B-375) (20)
- 2 - 77 01 462 872
- 3 - 77 04 001 972
- 4 - 77 00 711 329
- 5 - 77 03 046 069
- 6 - 79 03 053 118
- 7 - 77 03 016 142
- 8 - 77 00 711 328
- 9 - 77 03 006 104
- 10 - 77 03 074 235 (B-375)
- 11 - 77 00 699 743 (B-375)
- 12 - 77 00 699 742 (B-375)
- 13 - 77 04 001 971 (B-375)
- 14 - 77 04 001 970 (B-375)

- B373
- B372
- B376
- B37E
- B37I

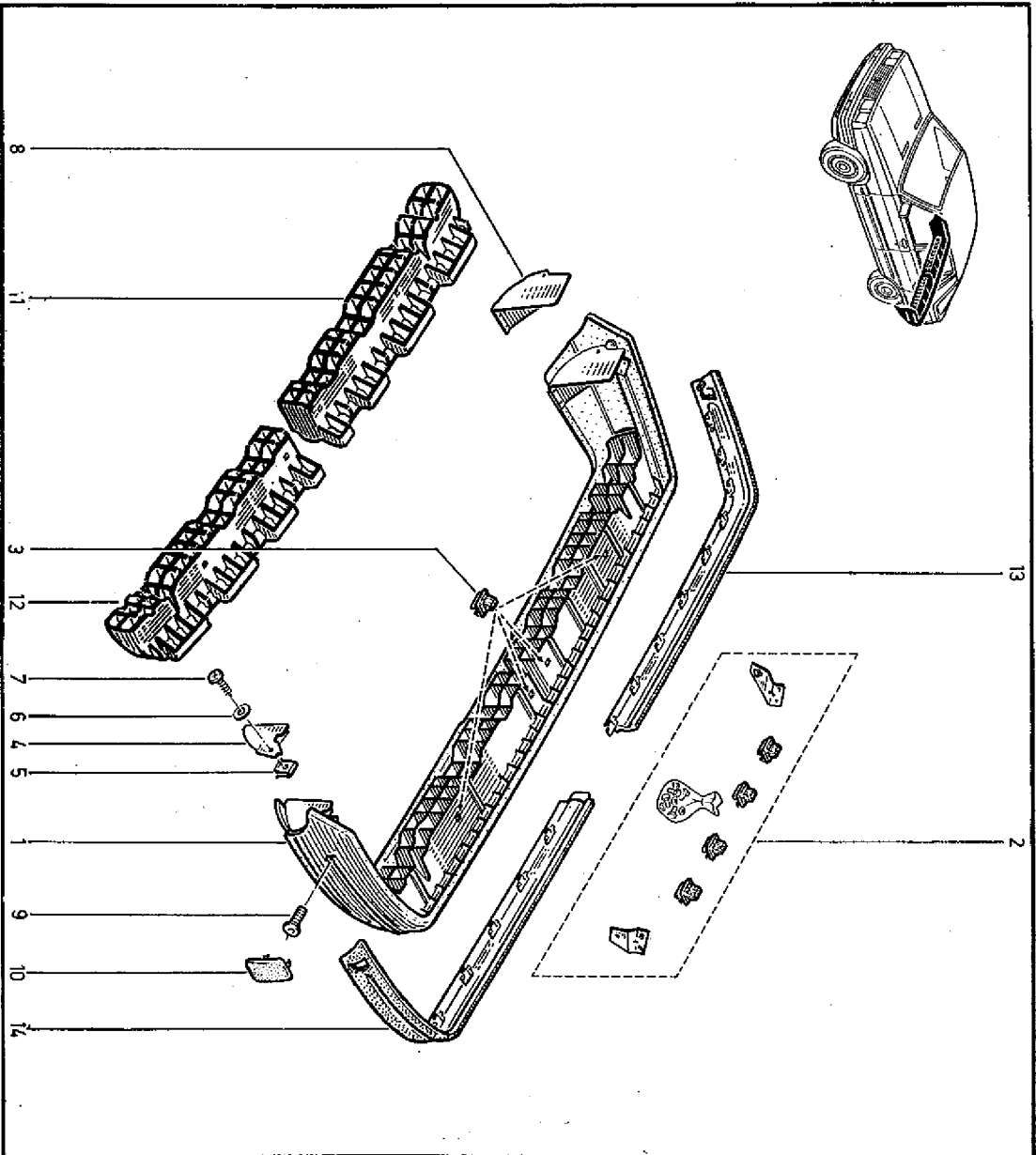

55.10
C.R.1037

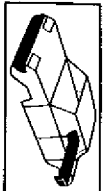

(20) 77 00 699 743-1
77 00 699 742-1

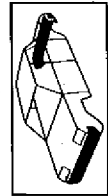

55.15
C.R.1037

- 1 - 77 00 751 289
- 2 - 77 03 011 065
- 77 03 072 177
- 3 - 77 03 080 026
- 4 - 77 03 081 024
- 5 - 77 03 016 304
- 77 03 016 314
- 6 - 77 03 074 266
- 7 - 77 00 751 285
- 8 - 77 00 751 291
- 9 - 77 00 751 283
- 10 - 77 00 751 290
- 11 - 77 00 751 292
- 12 - 77 00 751 286
- 13 - 77 00 751 284
- 14 - 77 03 072 046

B373

55.15
C.R.1037

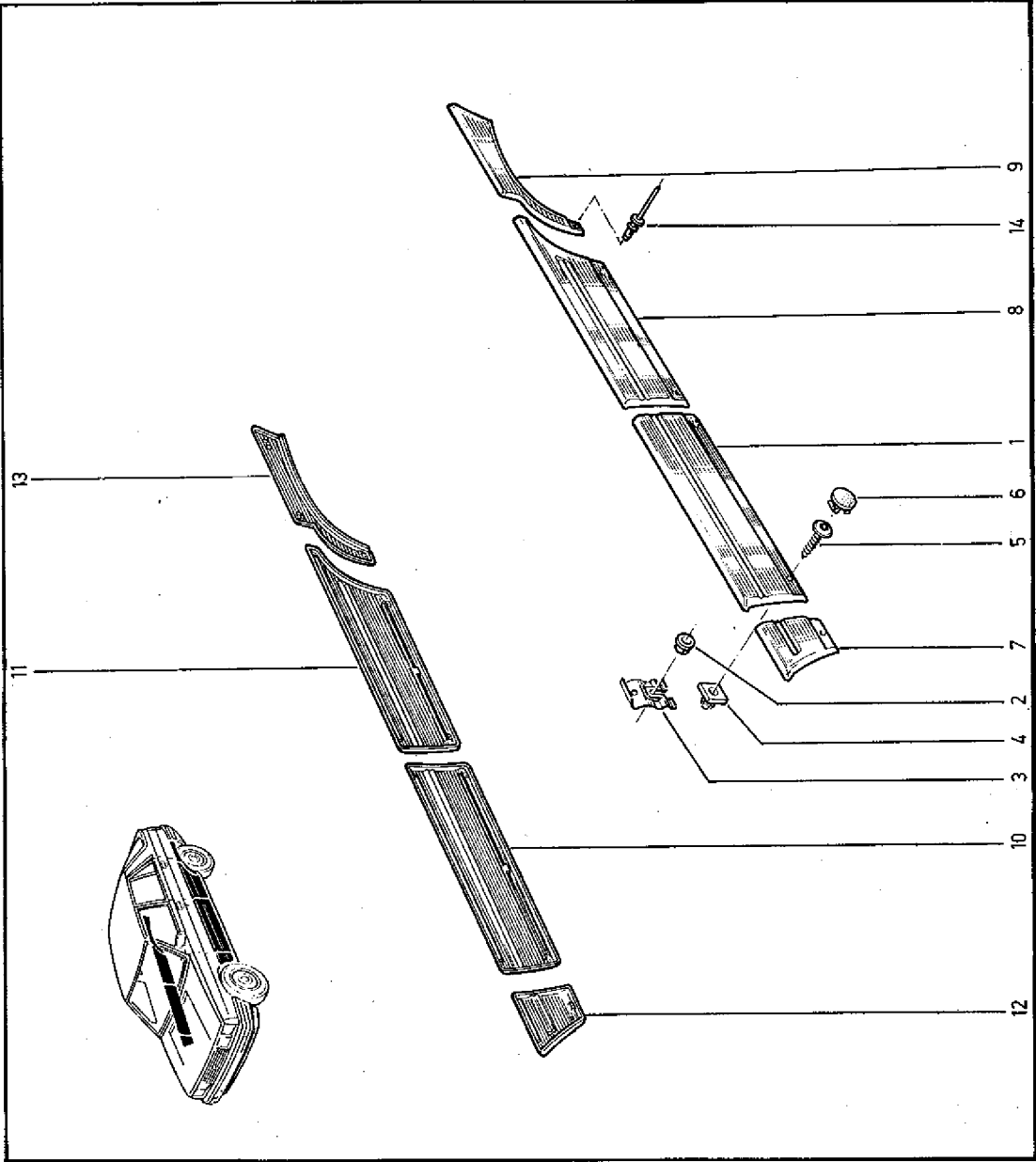
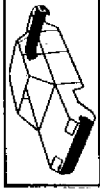



55.20
C.R.1037

- 1 - 77 04 003 694 (c)
- 77 02 081 582 (b)
- 77 00 752 422
- 2 - 77 03 035 008
- 3 - 77 03 077 055
- 77 03 077 152
- 77 02 081 594 (b)†
- 4 - 77 03 077 170
- 77 02 081 595 (b)
- 5 - 77 03 077 007
- 6 - 77 04 001 657 (a)
- 7 - 77 03 081 073 (a)
- 8 - 77 03 016 007 (a)
- 9 - 77 03 061 031 (a)
- 10 - 77 03 037 009 (a)
- 11 - 77 04 003 650 C-13
- 77 02 081 673 (e) [S3]
- 12 - 77 04 003 651 C-13
- 77 02 081 672 [S3]
- 13 - 77 02 081 583 (b)
- 14 - 77 02 081 584 (b)
- 15 - 77 02 081 712 (d)
- 16 - 77 02 081 714 (d)
- 17 - 77 02 081 716 (d)
- 18 - 77 02 081 718 (d)
- 19 - 77 02 081 711 (d)
- 20 - 77 02 081 713 (d)
- 21 - 77 02 081 715 (d)
- 22 - 77 02 081 717 (d)

(a) B373

55.20
C.R.1037

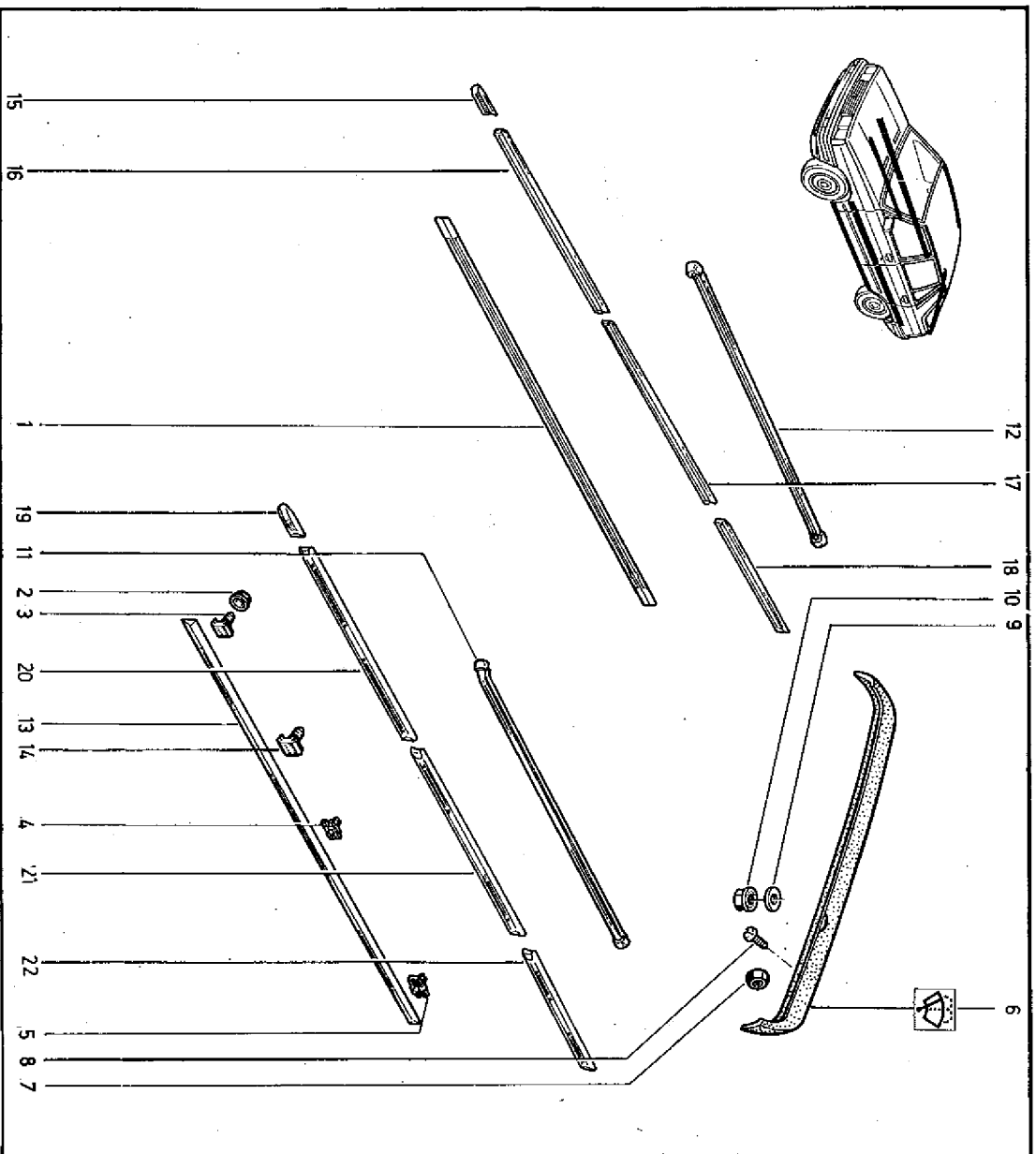

(b) B372 n° 07316 n° ...

(c) B373 n° 14803 n° ...

(d) B373 n° 1 n° ...

(e) B37C n° 1 n° ...



55.25
C.R.1037

B375

55.25
C.R.1037

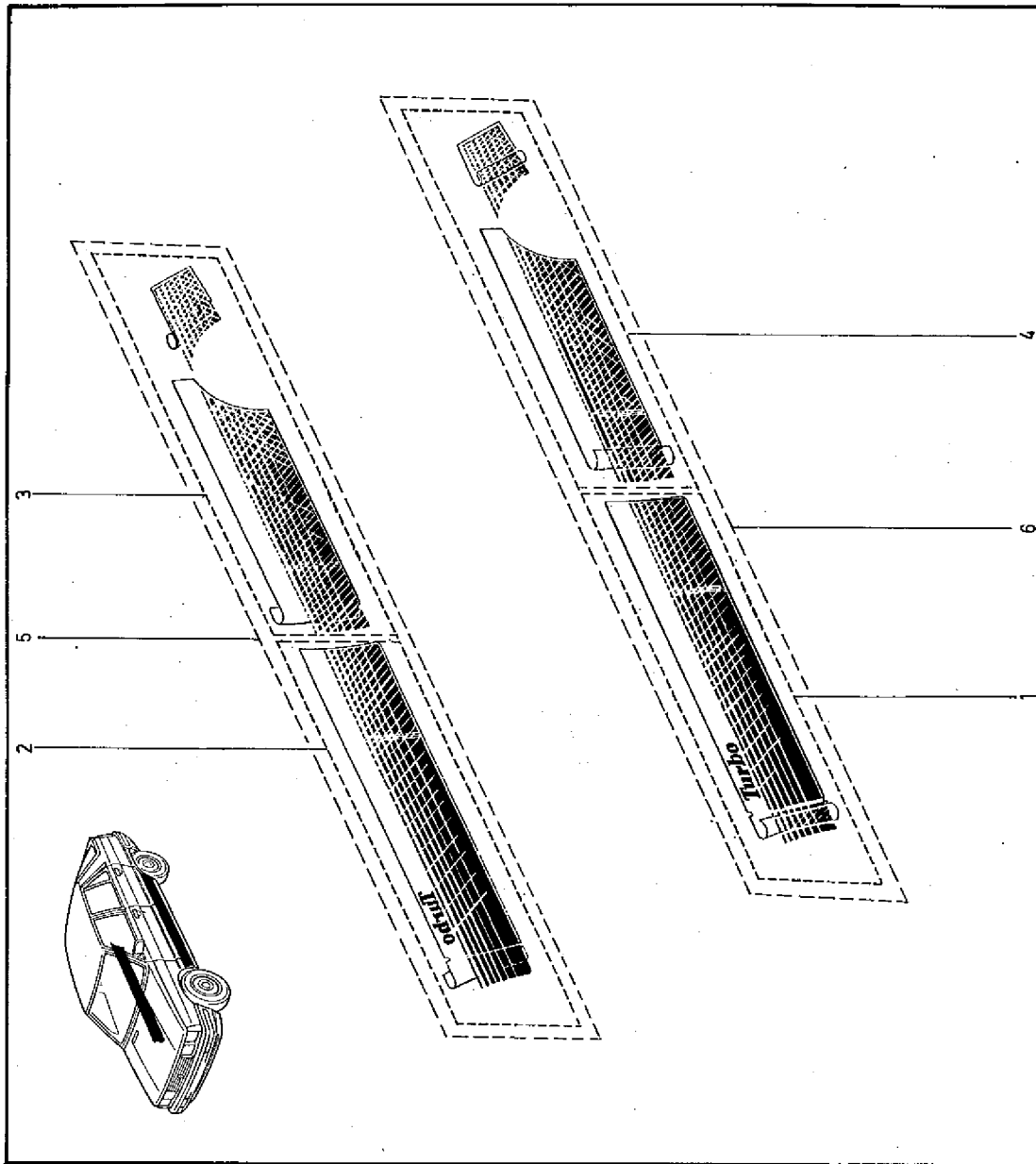

- 1 - 77 00 761 477 + (1)
- 2 - 77 00 761 476 + (2)
- 3 - 77 00 761 474 + (2)
- 4 - 77 00 761 475 + (1)
- 5 - 77 01 202 233
- 6 - 77 01 202 232

(1) 77 01 202 232-1
 (2) 77 01 202 233-1

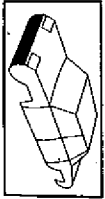

55.40
C.R.1037

- 1 - 77 04 002 029
- 77 00 766 919 (a)
- 2 - 77 00 642 478
- 77 00 759 387 (a)
- 3 - 77 03 081 049 +
- 77 03 081 019
- 4 - 77 03 016 304
- 5 - 77 03 016 154
- 6 - 77 04 002 027
- 77 00 767 163 (a)
- 7 - 00 13 103 200
- 8 - 77 04 002 028
- 77 00 767 164 (a)
- 9 - 77 04 000 878
- 10 - 77 04 000 879
- 11 - 77 04 001 459
- 12 - 77 03 077 120
- 13 - 77 03 072 227 +
- 77 03 072 230
- 14 - 77 04 001 460
- 15 - 77 03 077 151
- 16 - 77 03 081 064

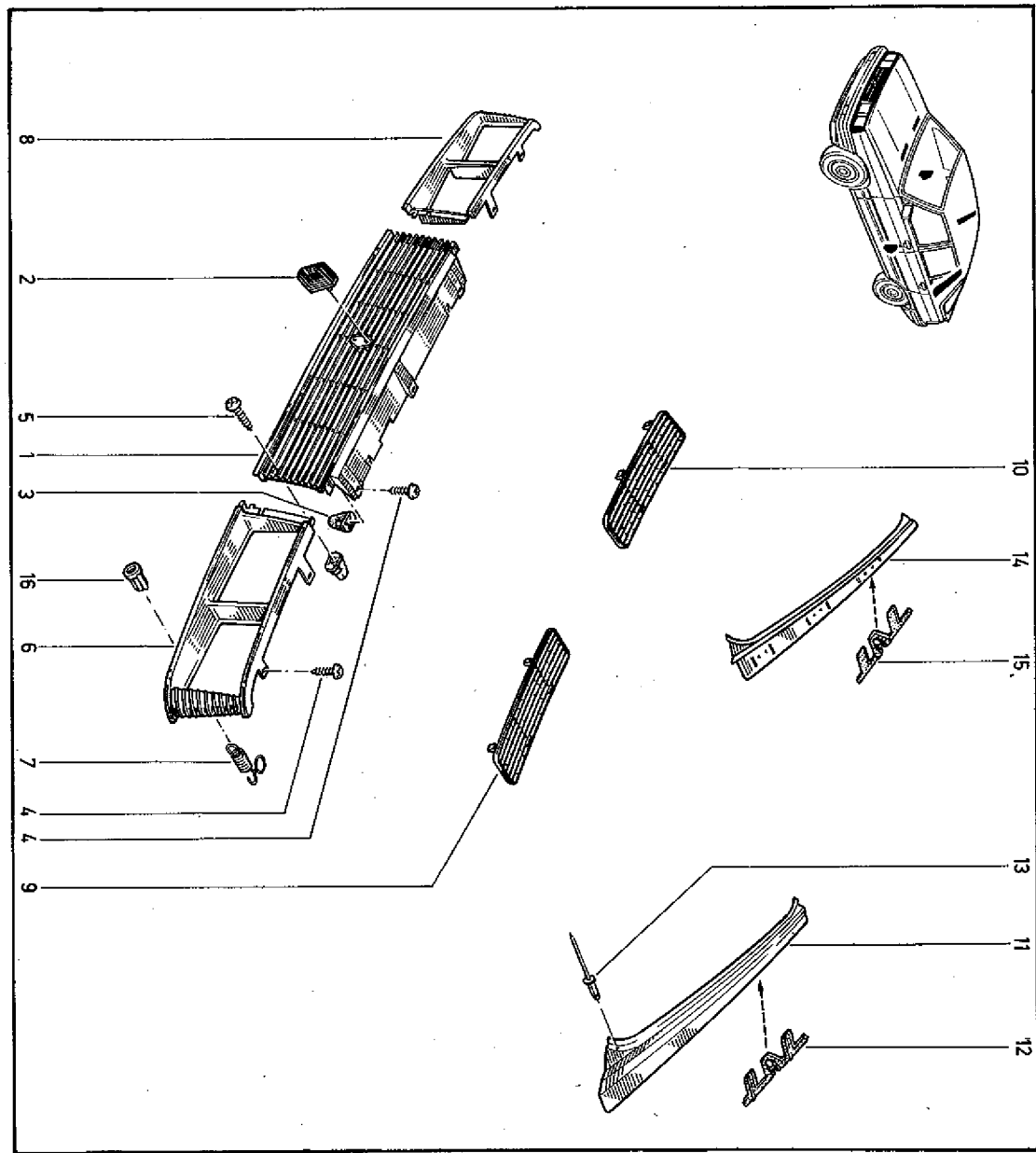

55.40
C.R.1037

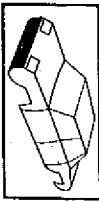

(a) B375



56.01
C.R.1037

- 1 - 77 02 081 487 (b)
- 2 - 77 00 640 963
- 3 - 77 00 751 343 (a)
- 4 - 77 00 754 282 (c)
- 5 - 77 00 754 283 (c)
- 77-00 771 191 (c)
- 6 - 77 00 751 355
- 7 - 77 00 751 347
- 8 - 77 00 754 392
- 9 - 77 00 751 356
- 10 - 77 02 091 954

- (a) B372
- (b) B373
- (c) B375

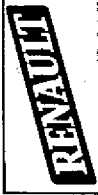

56.01
C.R.1037

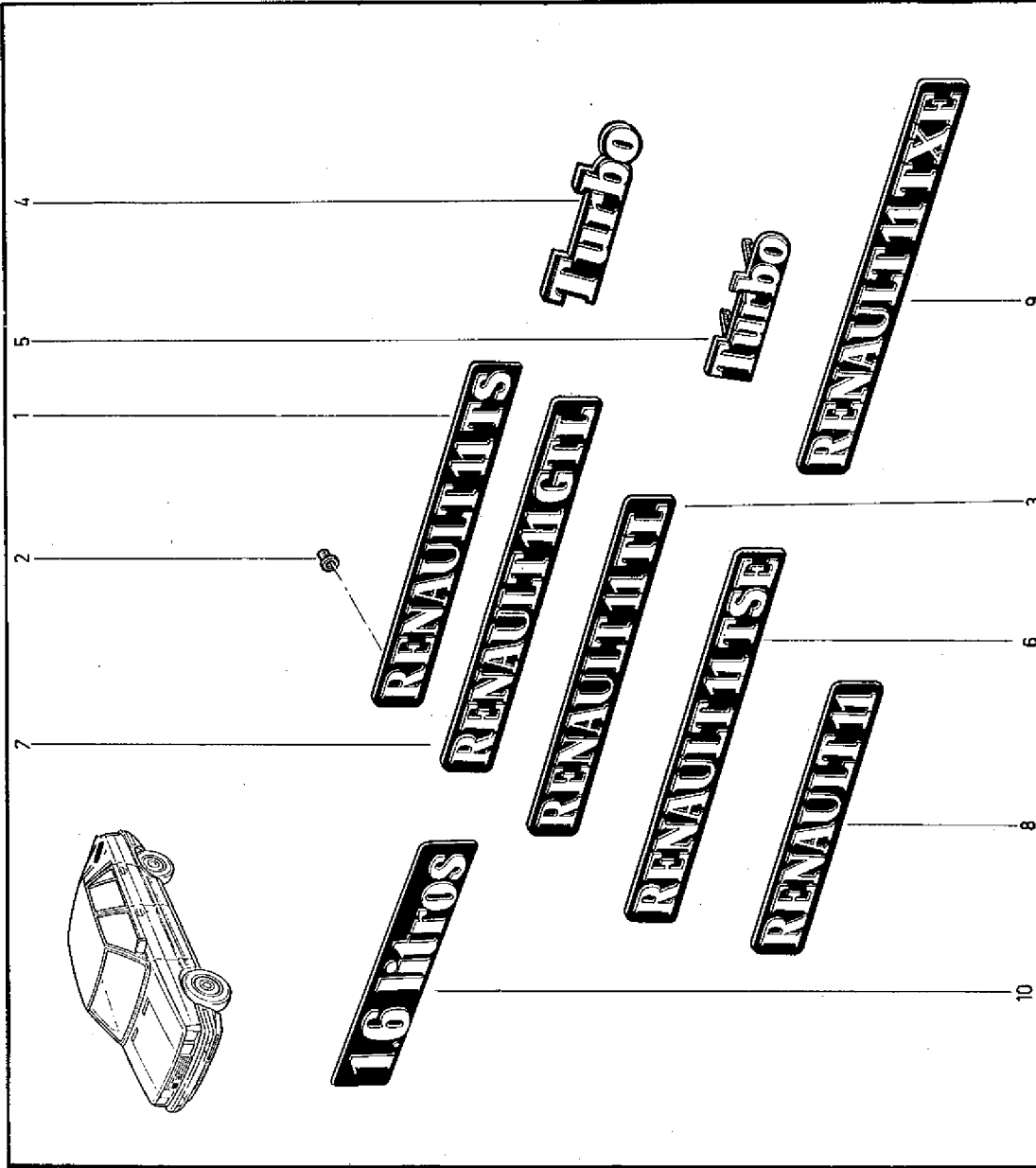



56.20
C.R.1037

- 1 - 77 01 349 604 +
- 77 04 003 485
- 2 - 77 00 764 328
- 3 - 77 03 056 058
- 4 - 77 03 008 038
- 5 - 77 04 003 484
- 6 - 77 00 716 084
- 7 - 77 00 708 548

B372

56.20
C.R.1037

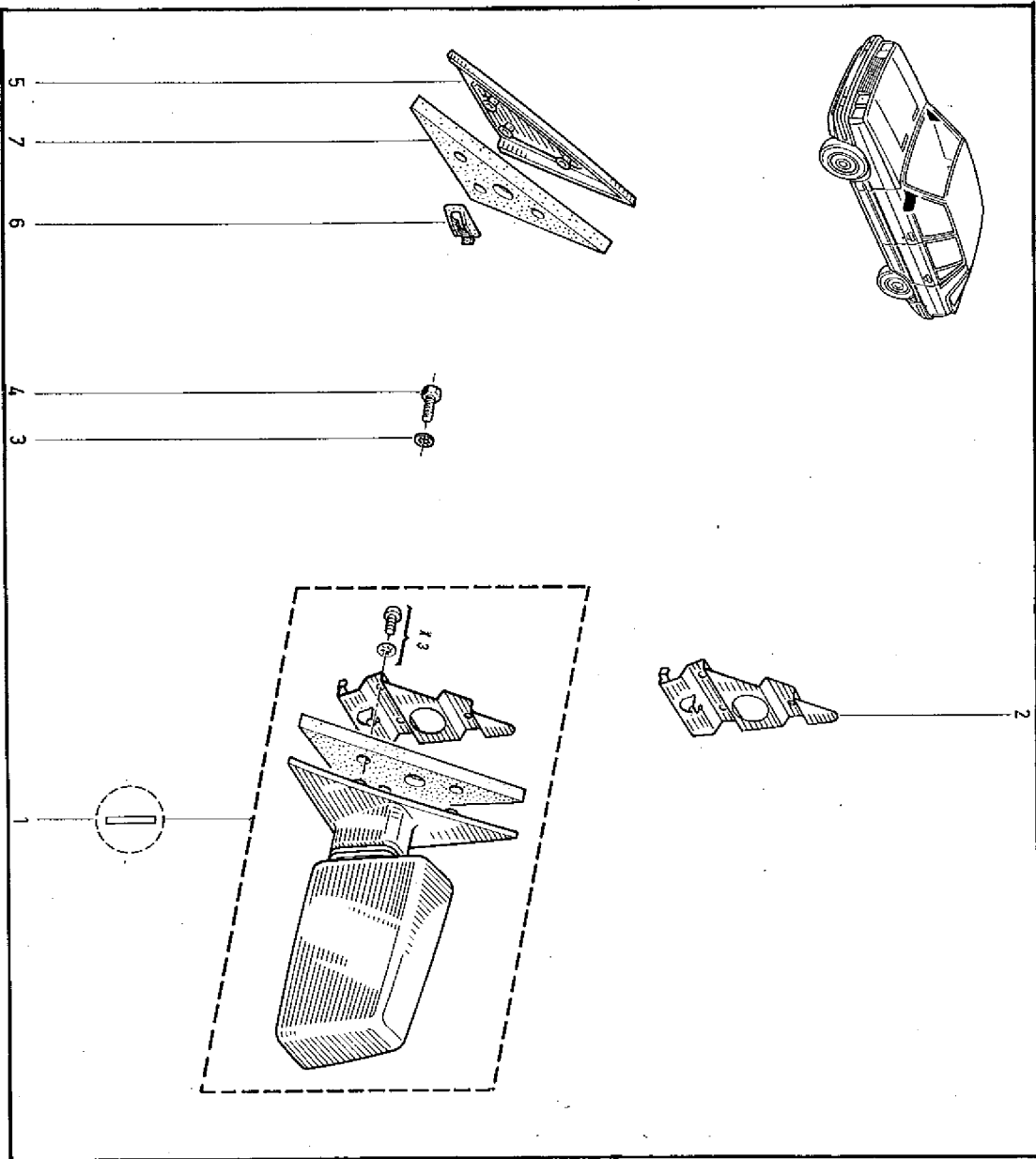



56.21
C.R.1037

B373 B37E B375

56.21
C.R.1037

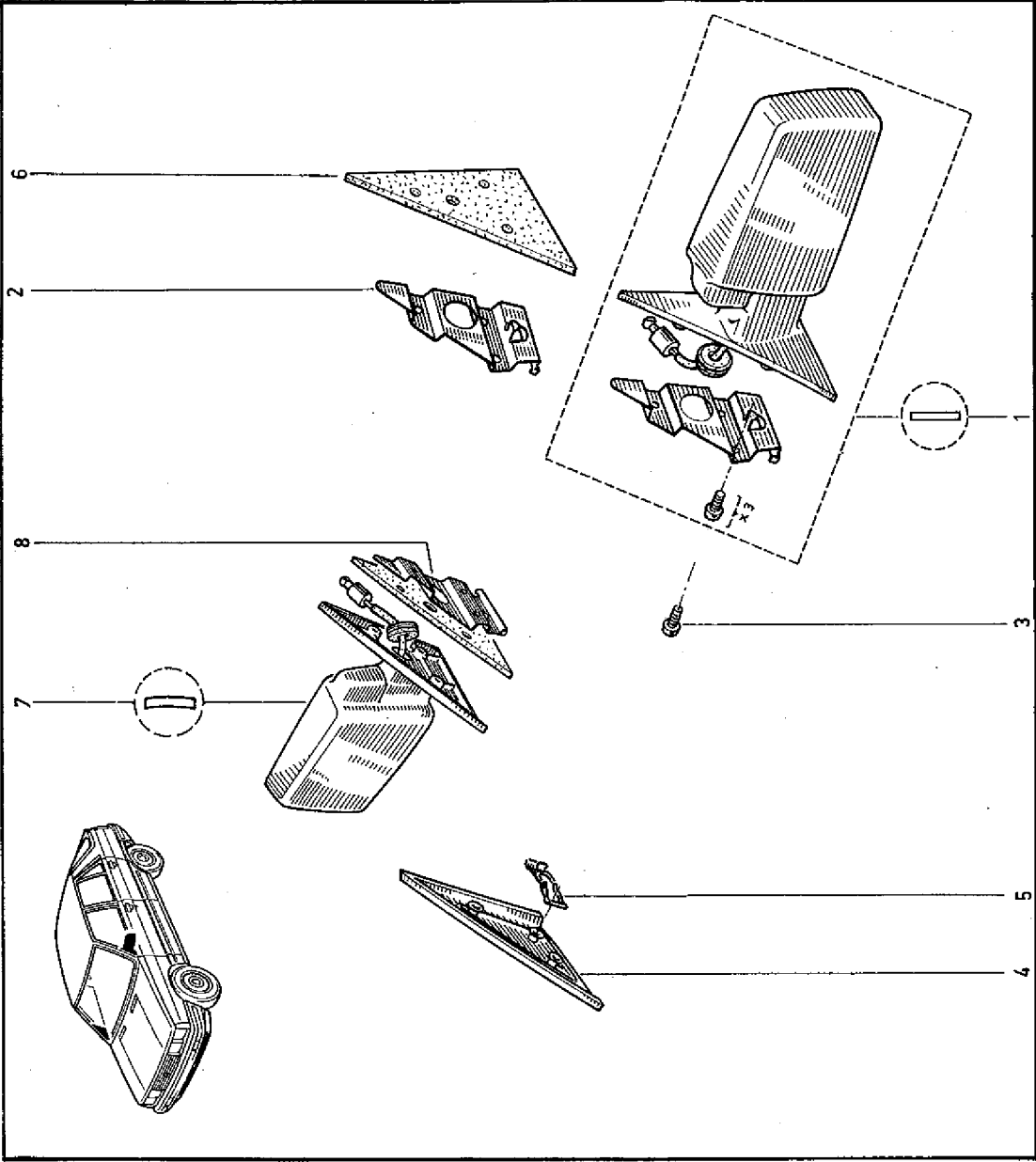

- 1 - 77 01 365 925
- 2 - 77 00 680 585
- 3 - 77 03 008 038
- 4 - 77 04 003 484
- 5 - 77 00 716 084
- 6 - 77 00 708 548
- 7 - 77 00 776 558
- 8 - 77 00 680 586

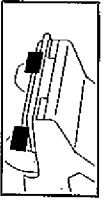

56.35
C.R.1037

- 1 - 77 03 081 028
- 2 - 77 03 016 285
- 3 - 77 03 058 048
- 4 - 77 04 003 006+
- 5 - 77 02 081 593
- 6 - 77 03 072 203 +
- 7 - 77 03 077 225
- 77 02 081 592
- 7 - 77 04 003 528 (a)
- 8 - 77 04 003 527 (a)

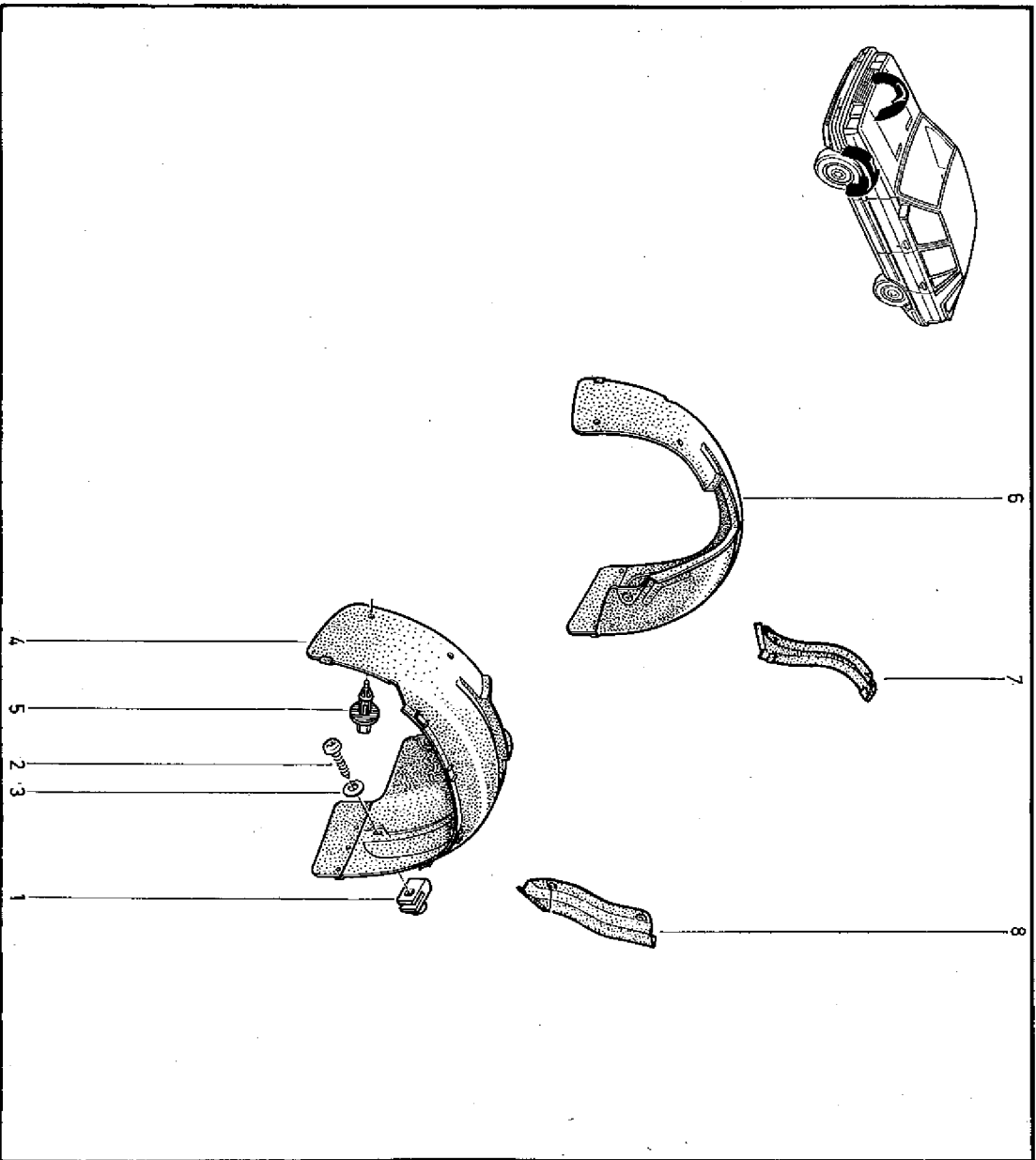

56.35
C.R.1037

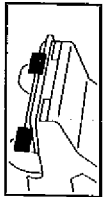

(a) B375

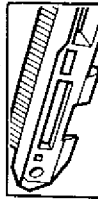

57.01
C.R. 1037

1 - 77 02 081 778 [2-3]	(d)	10 - 77 00 684 044 [5]
77 02 081 513 [2-3]	(a)†	77 00 695 266 [2-3] (b)
77 02 081 488 [2-3]	(a)†	11 - 77 00 684 042 [5]
77 02 081 503 [2-3]	(a)†	77 00 695 264 [2-3] (b)
77 02 081 514 [2-3]	(a)†	12 - 77 03 016 017
77 02 081 489 [2-0]	(a)†	13 - 77 00 753 551 [2-3] †
77 02 081 504 [2-0]	(a)†	77 01 613 248 [2-3]
77 02 081 515 [2-3] [2-3] (b)†	(a)†	77 02 081 646 [2-3]
77 02 081 490 [2-3] [2-3] (b)†	(a)†	77 00 753 550 [2-3] †
77 02 081 505 [2-3] [2-3] (b)†	(a)†	77 01 600 233 [2-3] †
77 02 081 491 [2-3] [2-3] (b)†	(a)†	77 02 081 645 [2-3] †
77 02 081 516 [2-3] [2-3] (b)†	(a)†	77 02 081 835 [2-3] [2-3]
77 02 081 506 [2-3] [2-3] (b)†	(a)†	14 - 77 00 691 527
77 00 765 910 [2-3] [2-3] (c)	(a)†	15 - 77 03 088 017
77 02 081 781 [2-0] [2-3] (e) (b)	(c)	16 - 77 00 685 496 [2-3] †
77 02 081 780 [2-0] [2-3] (a)	(a)	77 00 685 497 [2-3] †
77 02 081 779 [2-0] (d)	(d)	77 00 763 877 [2-3] (c)
77 02 081 834 [2-3] [2-3] (b)	(b)	77 00 763 878 [2-3]
2 - 77 04 000 863 †		17 - 77 00 685 500 [2-3] †
77 00 643 241		77 00 685 501 [2-3] †
77 00 768 048		77 00 763 881 [2-3]
3 - 77 00 699 951		77 00 763 882 [2-3]
4 - 77 04 000 851 [2-3]		18 - 77 00 754 258
77 04 002 082 [2-0]		19 - 77 05 035 065
77 04 001 041 [2-3]		20 - 77 05 017 001
77 04 001 043 [2-3]		21 - 77 03 080 002
77 00 763 917 [2-3] (c)	(c)	22 - 77 02 081 492
5 - 77 03 046 069		23 - 77 03 077 202 (c)
6 - 77 03 016 278		24 - 77 00 713 014 (c)
7 - 77 00 694 217 [2-3] (b)	(b)	25 - 77 02 081 826
77 00 694 219 [2-3] (a)	(a)	
77 00 694 221 [2-3] (b)	(b)	
77 00 713 844 [2-3] (a)	(a)	
8 - 77 00 694 218 [2-3] (b)	(b)	
77 00 694 220 [2-3] (a)	(a)	
77 00 694 222 [2-3] (b)	(b)	
77 00 713 845 [2-3] (a)	(a)	
9 - 77 00 684 043 [2-3]		
77 00 695 267 [2-3] (b)	(b)	

- (a) X B 372
- (b) X B 373 - B 37E
- (c) X B 375
- (a) B 373 n° 1 → n° 30738
- (b) B 373 n° 30734 → n°
- (c) B 37G n° 1 → n° 6620
- (d) B 37G n° 6621 → n°
- (e) B 37T n° 1 → n°

57.01
C.R. 1037

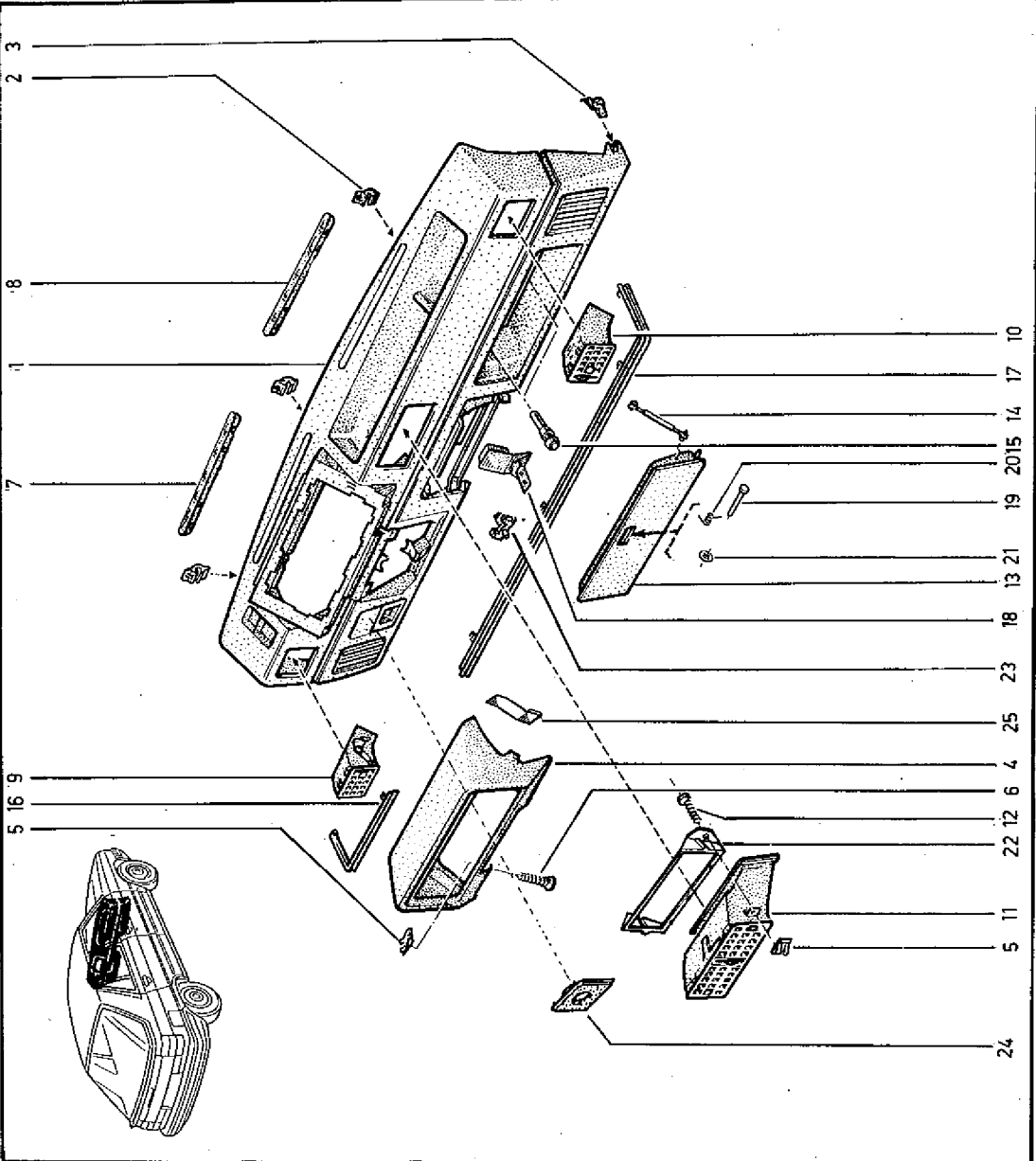
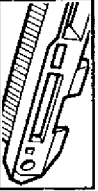

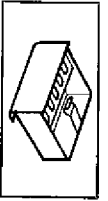

57.30
C.R.1037

- 1 - 77 04 001 164
- 2 - 77 00 690 115 331
- 77 04 001 075 133 +
- 77 00 648 261 133

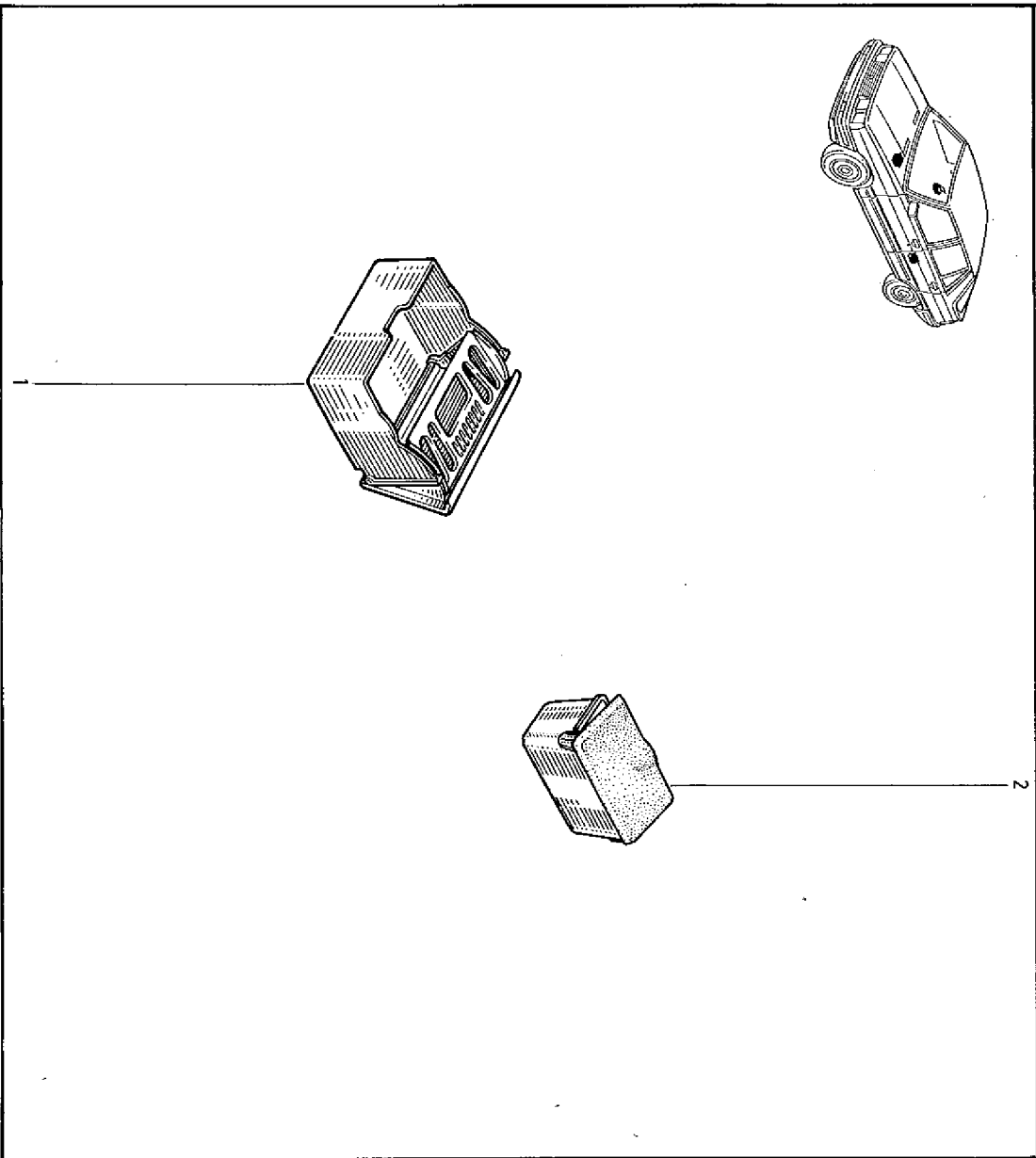

57.30
C.R.1037

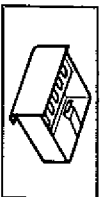



58.20
C.R.1037

- 1 - 77 01 348 750 †
- 77 02 071 838
- 2 - 77 02 071 788
- 3 - 77 00 655 281



58.20
C.R.1037

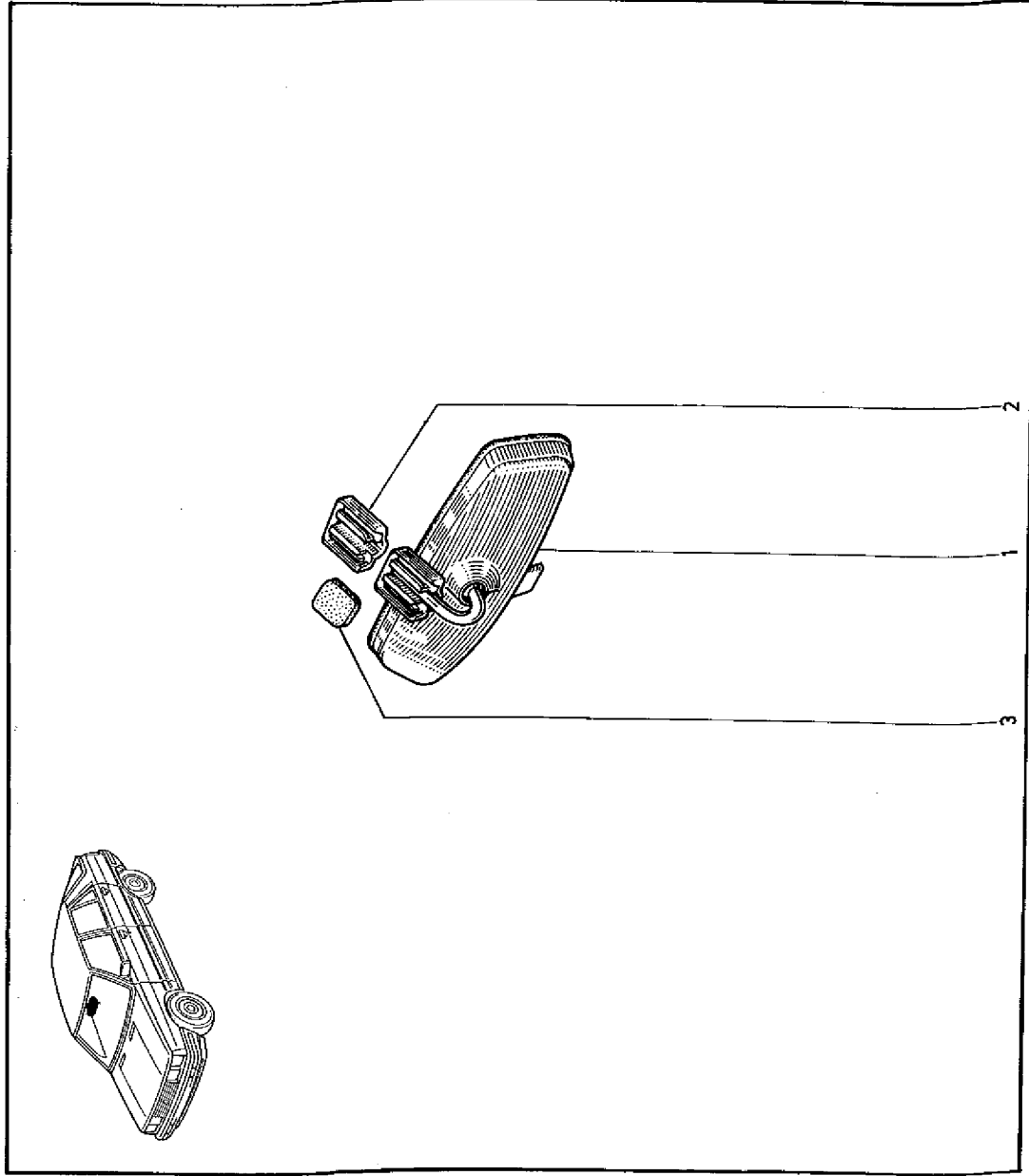

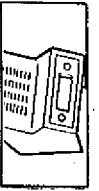

58.30
C.R.1037

- 1 - 77 02 081 484 (a)
- 77 00 765 256 (a) + (a)
- 77 00 759 383 (a) +
- 77 02 081 488 (a) (a)
- 77 02 081 831 (a)
- 77 02 081 486 (b)
- 77 00 765 254 (a) + (b)
- 77 00 759 385 (a) + (b)
- 2 - 77 00 698 899
- 3 - 77 03 016 078
- 4 - 77 00 676 238
- 5 - 77 00 676 237
- 6 - 77 04 001 164
- 7 - 77 00 686 719 (b)
- 8 - 77 00 692 265
- 9 - 77 03 016 154
- 10 - 77 00 728 024
- 11 - 77 04 003 384 +
- 77 04 001 166 + (1)
- 12 - 77 02 089 306 +
- 77 04 003 384 +
- 13 - 77 01 613 474 +
- 77 02 081 693 (b)
- 77 02 081 735 (a)

(a) / B372 - B37G
(b) / B373 - B375 - B37I - B37E

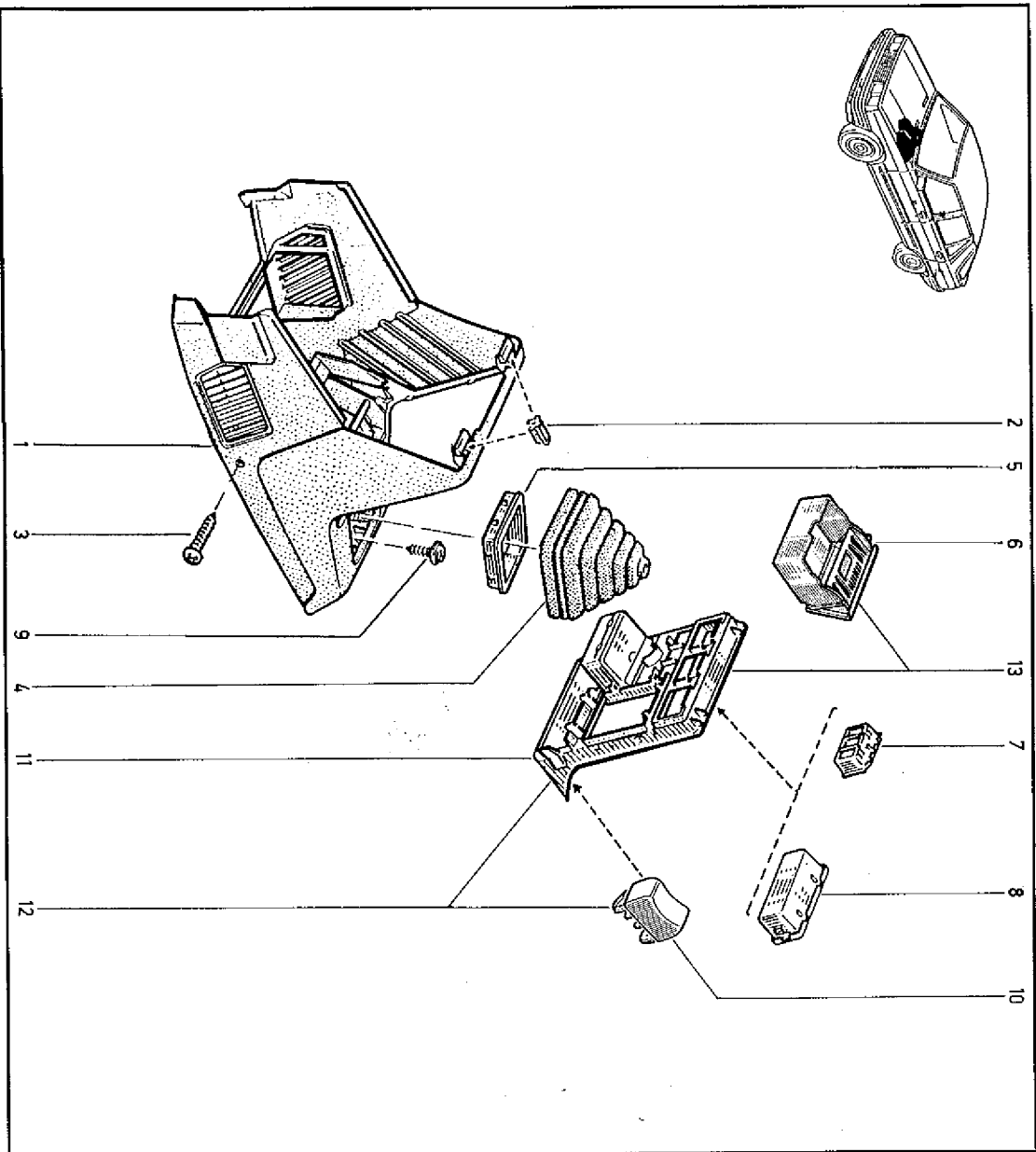

58.30
C.R.1037

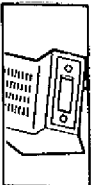

(1) 77 02 089 306

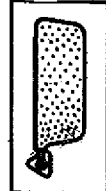

58.40
C.R.1037

- 1 - 77 02 082 005 XE1
- 2 - 77 02 082 007 XE1
- 3 - 8535233
- 4 - 77 03 016 303
- 5 - 77 00 687 914 XE1
- 6 - 77 02 082 006 XE1
- 7 - 77 00 690 436
- 8 - 77 00 750 314 XE1
- 9 - 77 05 098 000
- 10 - 77 00 712 536 XE1
- 11 - 77 00 696 835 XE1
- 12 - 77 04 002 009 XE1
- 11 - 77 04 002 364 XE1 (a)
- 12 - 77 05 003 016 (a)

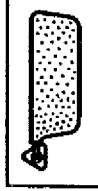

58.40
C.R.1037

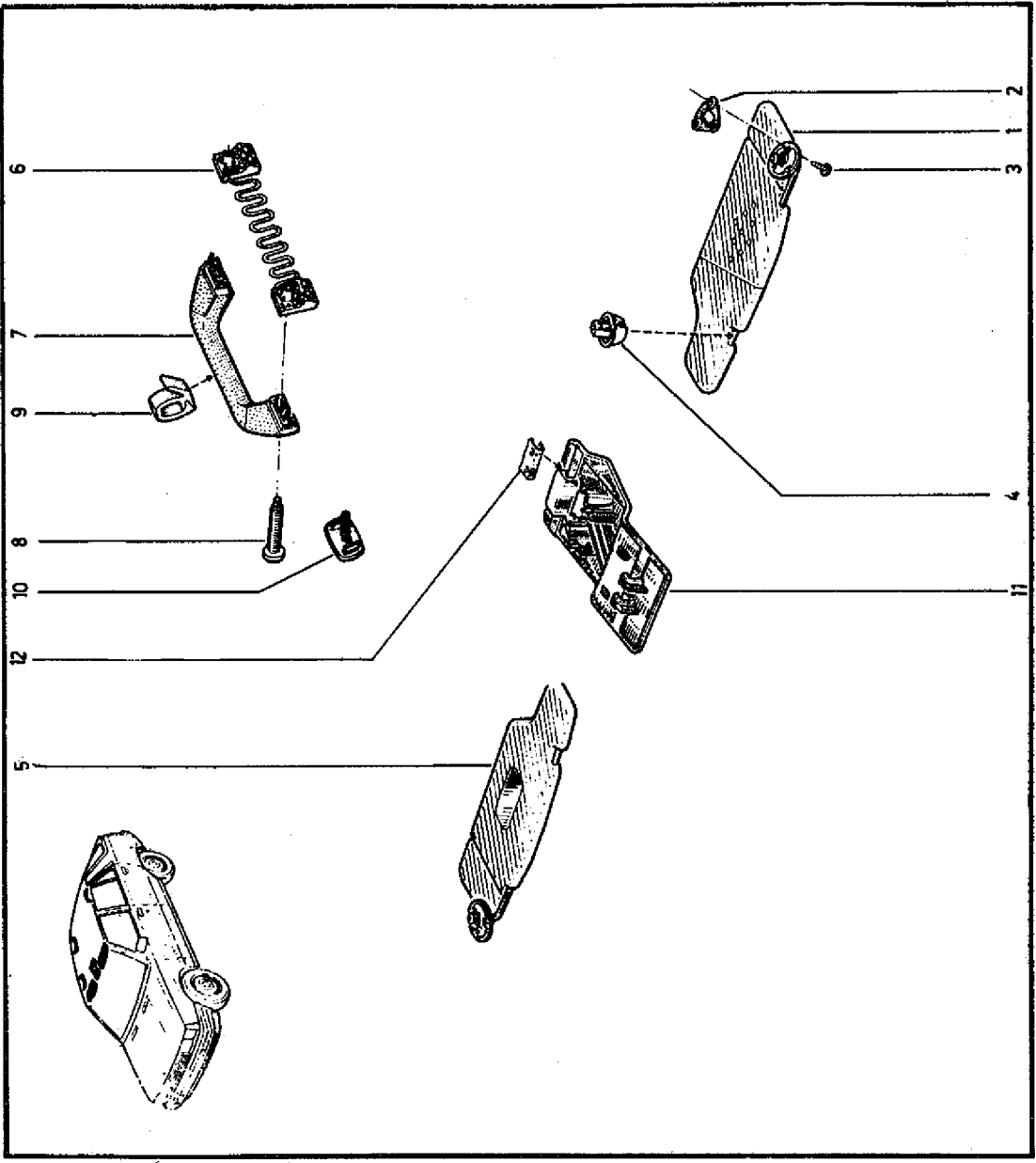

(a) B375

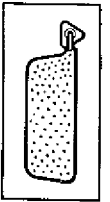

58.40.1
01.89 C.R.1037

- 1- 77 02 204 635
- 77 02 208 341
- 77 02 204 637
- 2- 8535233
- 3- 77 03 016 303
- 4- 77 02 097 782
- 77 00 687 914
- 5- 77 02 204 634
- 77 02 208 340
- 77 02 204 636
- 6- 77 00 690 346
- 7- 77 00 750 315
- 77 02 204 638
- 8- 77 05 098 000
- 9- 77 02 204 641
- 77 00 696 838
- 10- 77 02 204 698
- 77 04 001 256
- 11- 77 02 081 830
- 77 04 002 363
- 12- 77 05 003 016

58.40.1
C.R.1037

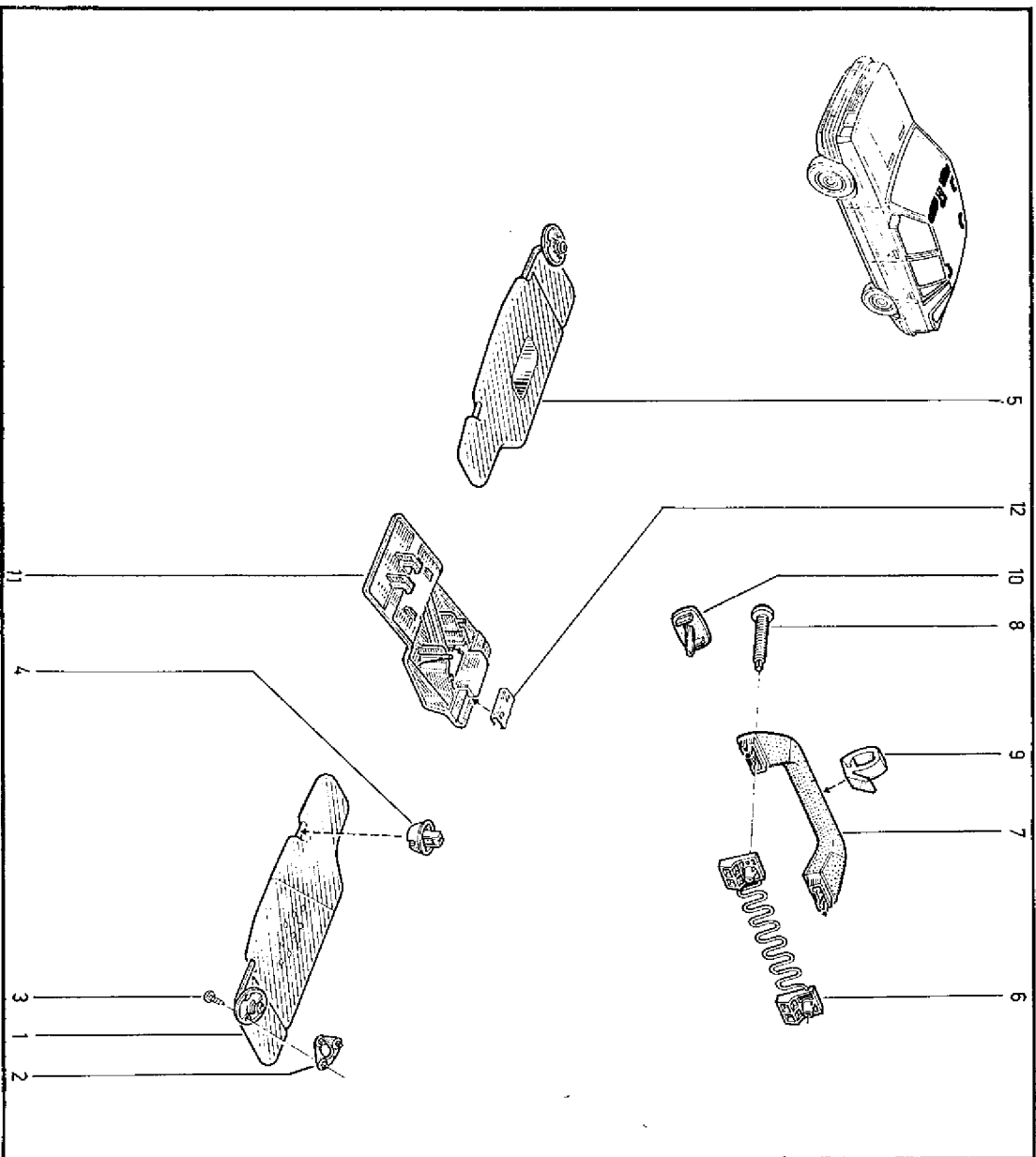
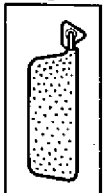

B 376		n° 6621		n°
B 373		n° 30734		n°
B 371		1		n°
B 375		n° 732		n°



59.20
C.R.1037

1-77	02	081	478	(B)(K)
77	02	081	477	(A)(K)
2-77	02	060	785	(B)(L)
77	02	091	014	(B)(K)
77	02	088	755	(B)(L)
3-77	00	673	971	
4-79	03	056	048	
5-77	00	639	743	
6-77	02	060	826	
7-77	01	000	954	
8-77	01	000	955	
9-77	00	547	334	
10-77	02	071	350	
11-77	02	081	434	(a)
77	02	060	787	(b)
12-77	02	060	784	
13-77	02	091	013	(A)(K)
77	02	088	756	(A)(L)
14-77	02	088	792	
15-77	02	088	753	(B)(L)
77	02	088	754	(A)(L)
16-77	02	060	785	(A)(B)(b)
17-77	02	079	333	(b)(L)
77	02	078	806	(b)(K)
77	02	081	689	(a)(L)
77	02	081	483	(a)(K)
18-77	02	060	786	(K)(L)(b)(A)(B)

/	B37E
(a) /	B373
	B375
(b) /	B37G

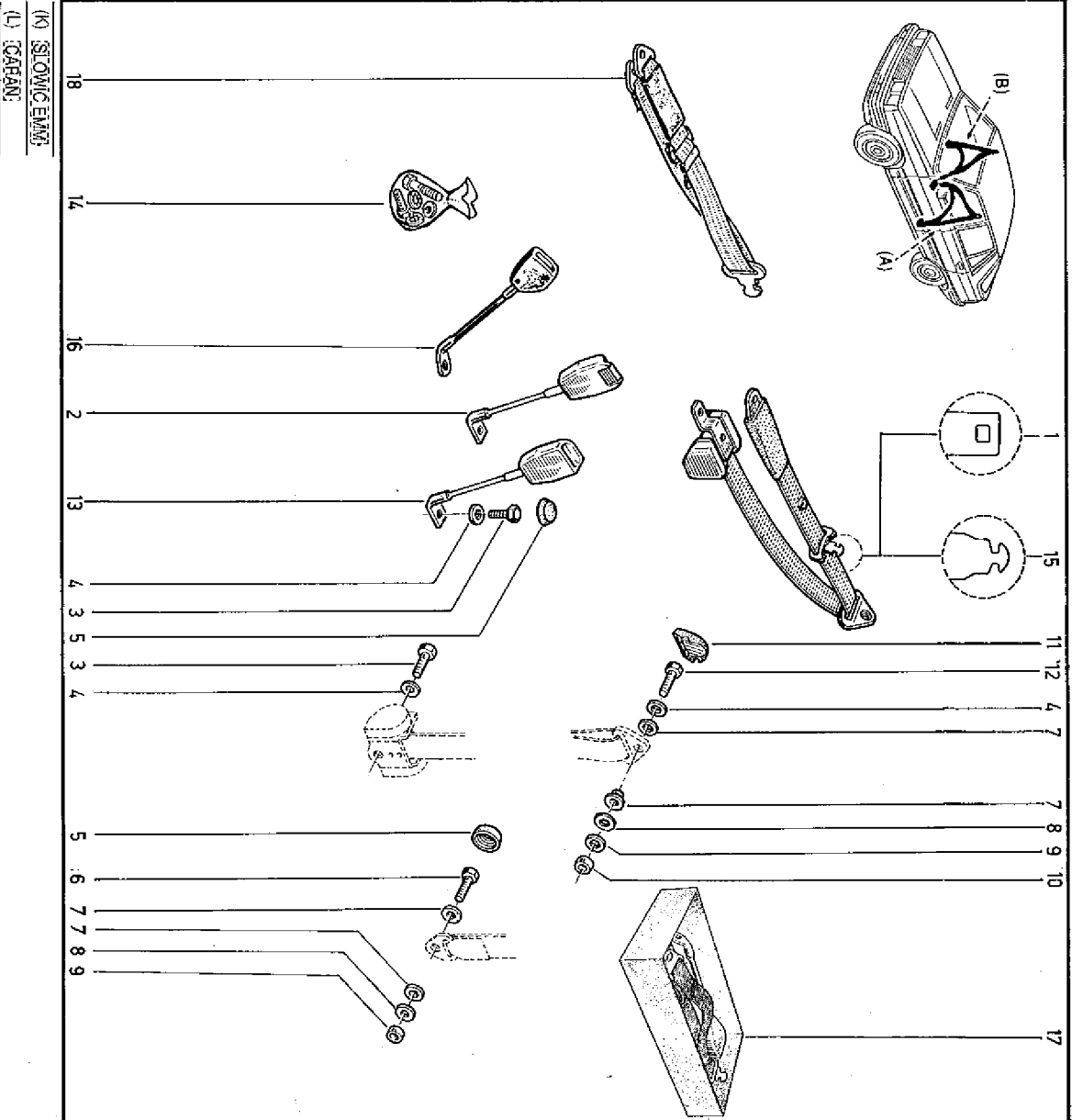

59.20
C.R.1037



59.50
C.R.1037



- 1 - 77 02 088 891 (a)
- 2 - 77 02 081 446 (b)
- 3 - 77 02 081 448
- 4 - 77 02 060 784
- 5 - 77 01 000 955
- 6 - 77 01 000 954
- 7 - 77 00 672 817
- 8 - 77 02 071 350
- 9 - 77 00 547 334
- 10 - 77 01 000 957
- 11 - 77 02 060 826
- 12 - 77 02 088 890 (c)
- 13 - 77 02 088 890 (c)

59.50
C.R.1037

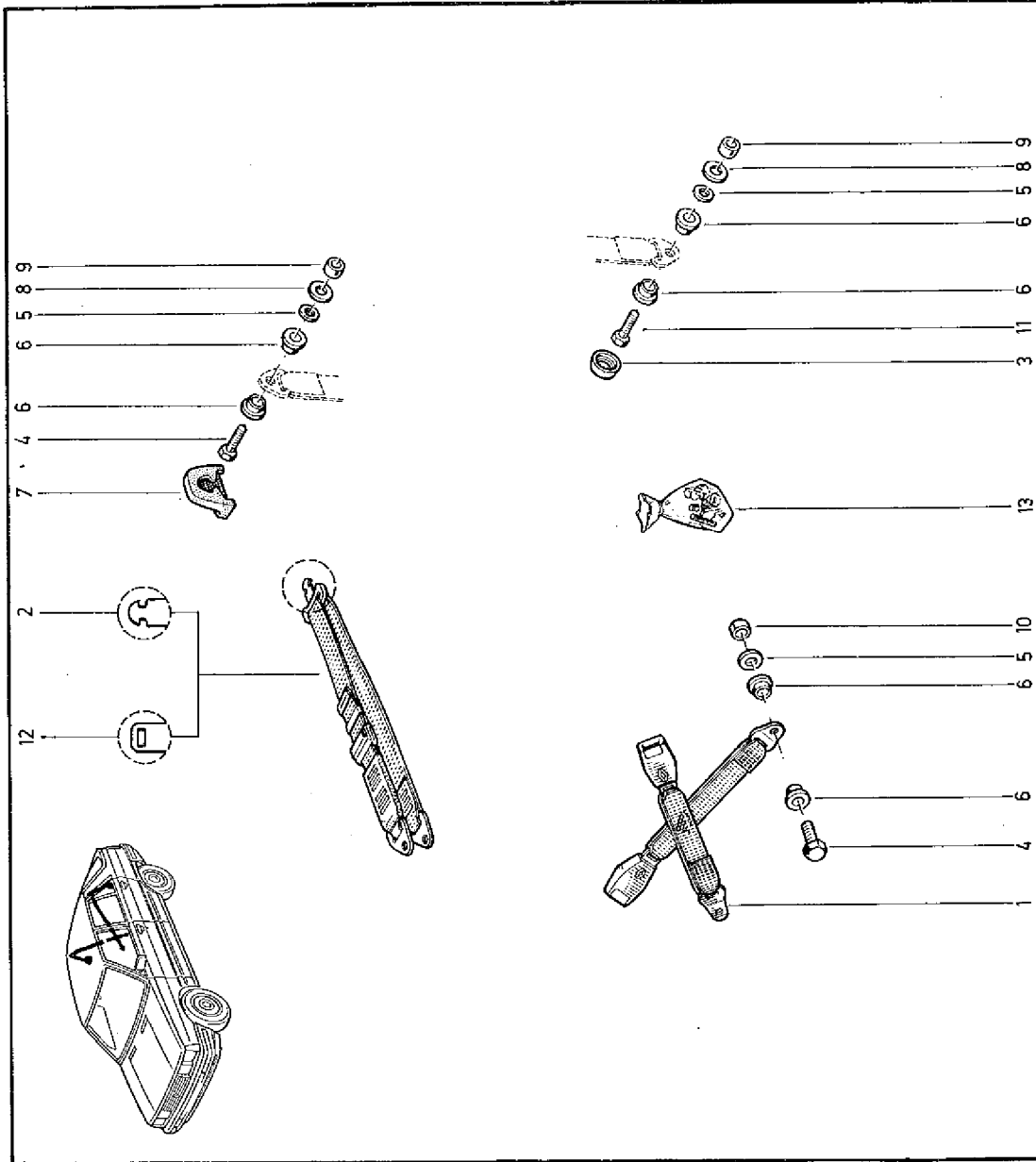

(c)	B37G	n°	1	□	n° 01477
	B373	n°	1	□	n° 020349
	B37E	n°	1	□	n° 01897
	B37S	n°	1	□	n° 00544

(a)	77 02 088 890
(b)	77 02 081 448



59.51
CR1037

- 1 - 77 02 071 1633E1 (A) (a)
 - 77 02 091 1103E1 (B) (a)
 - 77 02 081 7453E1 (B) (b)
 - 77 02 081 7463E1 (A) (b)
- 2 - 77 03 074 1213E1

59.51
CR1037

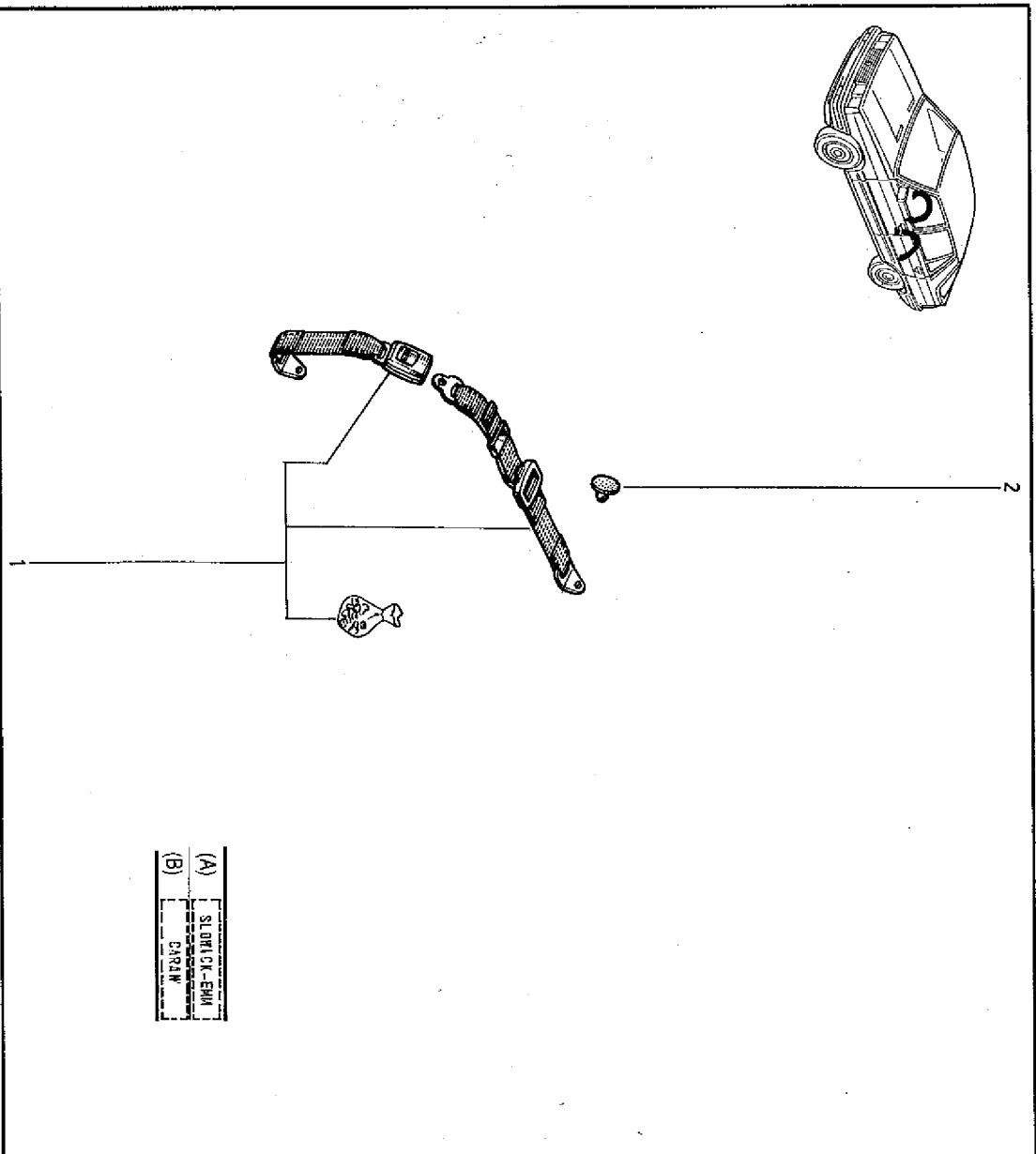

(a)

B37G	II	n° 001478	⇨	II	n° 03886
B373	II	n° 020350	⇨	II	n° 024394
B37E	II	n° 01888	⇨	II	n° 02274
B375	II	n° 00544	⇨	II	n° 00585

(b)

B37G	II	n° 03887	⇨	II	n° ...
B373	II	n° 024395	⇨	II	n° ...
B37E	II	n° 02275	⇨	II	n° ...
B375	II	n° 00586	⇨	II	n° ...



60.10
C.R. 1037

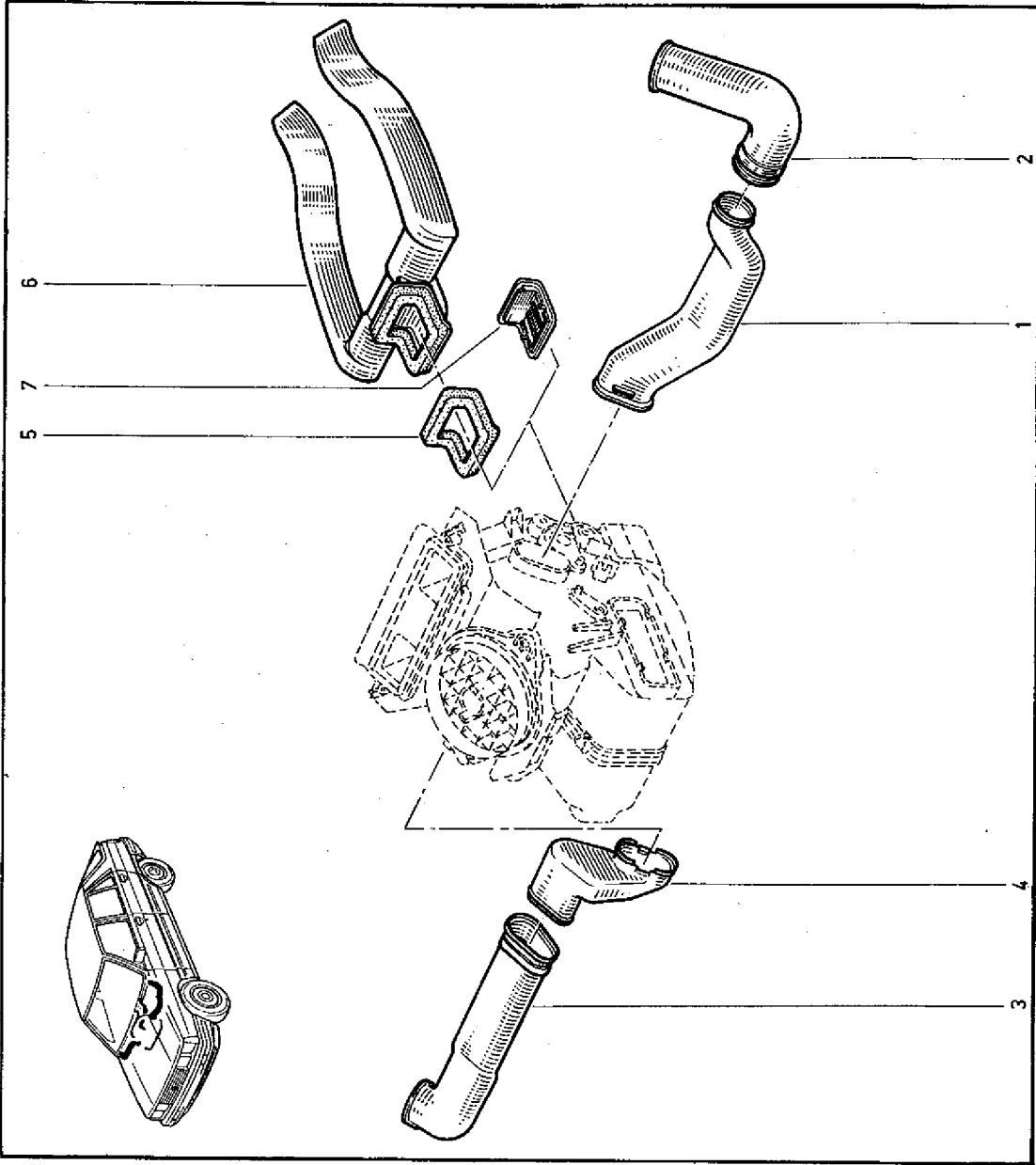

60.10
C.R. 1037

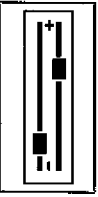

- 1 - 77 00 692 161
- 2 - 77 00 692 162
- 3 - 77 00 697 530
- 4 - 77 00 697 531
- 5 - 77 00 692 904 (b)
- 6 - 77 00 692 078 (b)
- 7 - 77 00 750 636 (a)

(a) B372
(b) B373

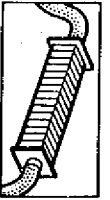

C.R.1037

60.20

- 1 - 77 01 201 953 ☒
77 01 201 955 ○
- 2 - 77 01 027 039 ☒
77 01 029 244 ○
- 3 - 77 01 027 040 +
77 01 349 831 +
77 01 034 109
- 4 - 77 01 027 050 ☒
- 5 - 77 01 027 048 ☒
6 - 77 01 029 248 +
77 01 027 044 +
77 01 349 817 +
77 02 088 744 +
77 02 088 745 +
- 7 - 77 01 029 249 ☒ +
77 01 029 250 ○ +
77 01 028 685
- 8 - 77 01 029 814 ☒
77 01 029 815 ○
- 9 - 77 01 029 242 ☒ +
77 02 088 751 ☒
77 01 029 243 ○ +
77 01 029 664 ○ +
77 02 206 205 ○
- 10 - 77 01 029 241 +
77 01 028 386
- 11 - 77 01 029 240 +
77 01 028 384 +
77 02 088 746
- 12 - 77 01 028 382 ○
77 01 028 383 ☒
- 13 - 77 01 202 003 +
77 01 202 012
- 14 - 77 00 614 940
- 15 - 77 01 030 200 ○ +
77 02 088 619 ○
- 16 - 77 01 031 390 ○ +
77 01 031 741 ○

B 37E	☒	1 →	n°002941
B 373	☒	1 →	n°027733
B 375	☒	1 →	n°000672

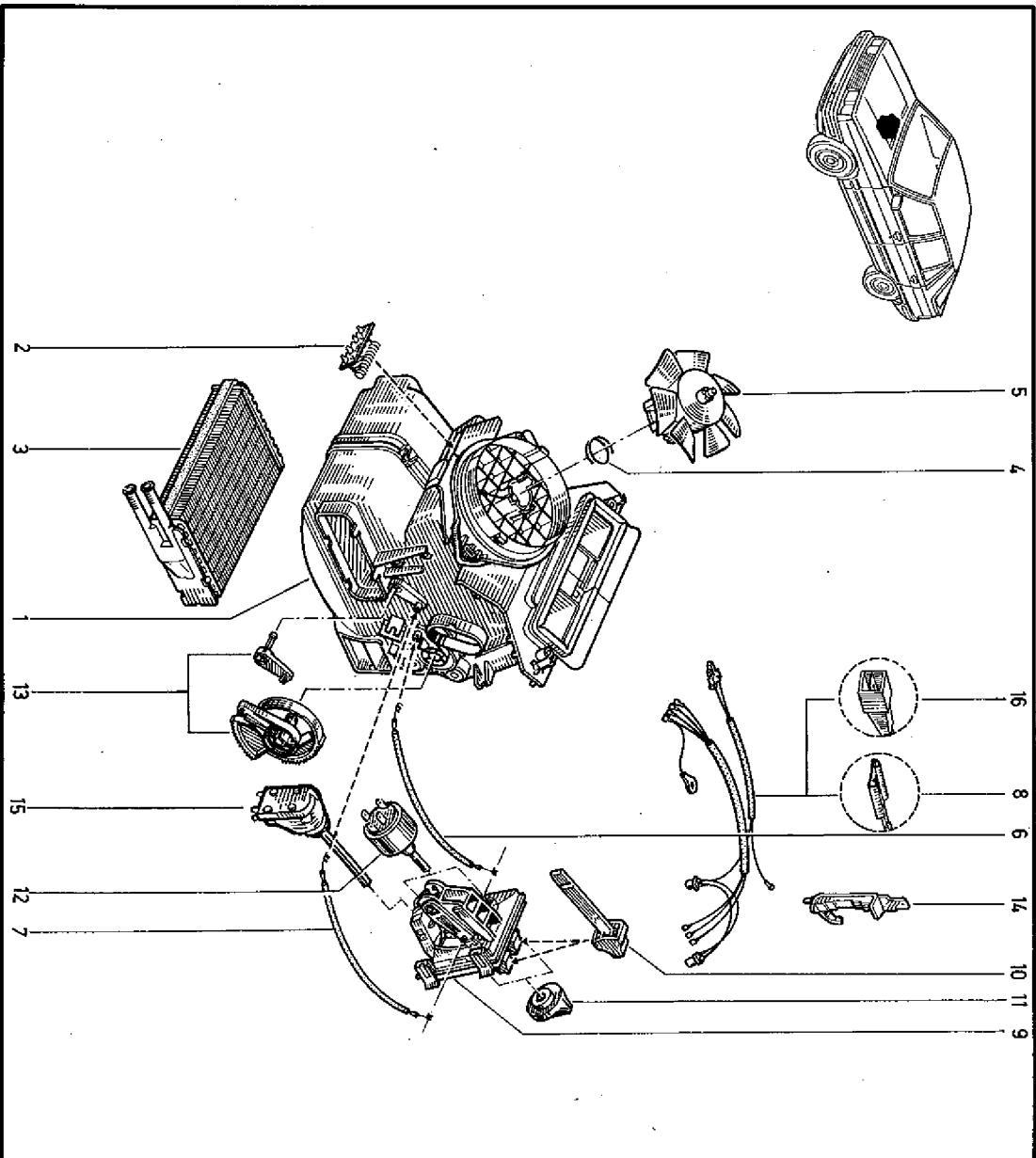

C.R.1037

60.20

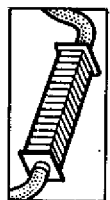

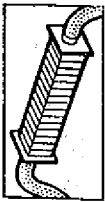

60.20.1
C.R.1087

- 1 - 77 02 088 740
- 2 - 77 02 088 752
- 3 - 77 02 088 742
- 4 - 77 02 088 743
- 5 - 77 02 088 750
- 6 - 77 02 088 744 +
- 77 02 088 745
- 7 - 77 02 088 745
- 8 - 77 02 206 021
- 9 - 77 02 206 022
- 10 - 77 02 088 749
- 11 - 77 02 088 746
- 12 - 77 02 089 506
- 13 - 77 02 088 741
- 14 - 77 02 206 024
- 15 - 77 02 206 025
- 16 - 77 02 206 205
- 17 - 77 02 206 209



60.20.1
C.R.1087

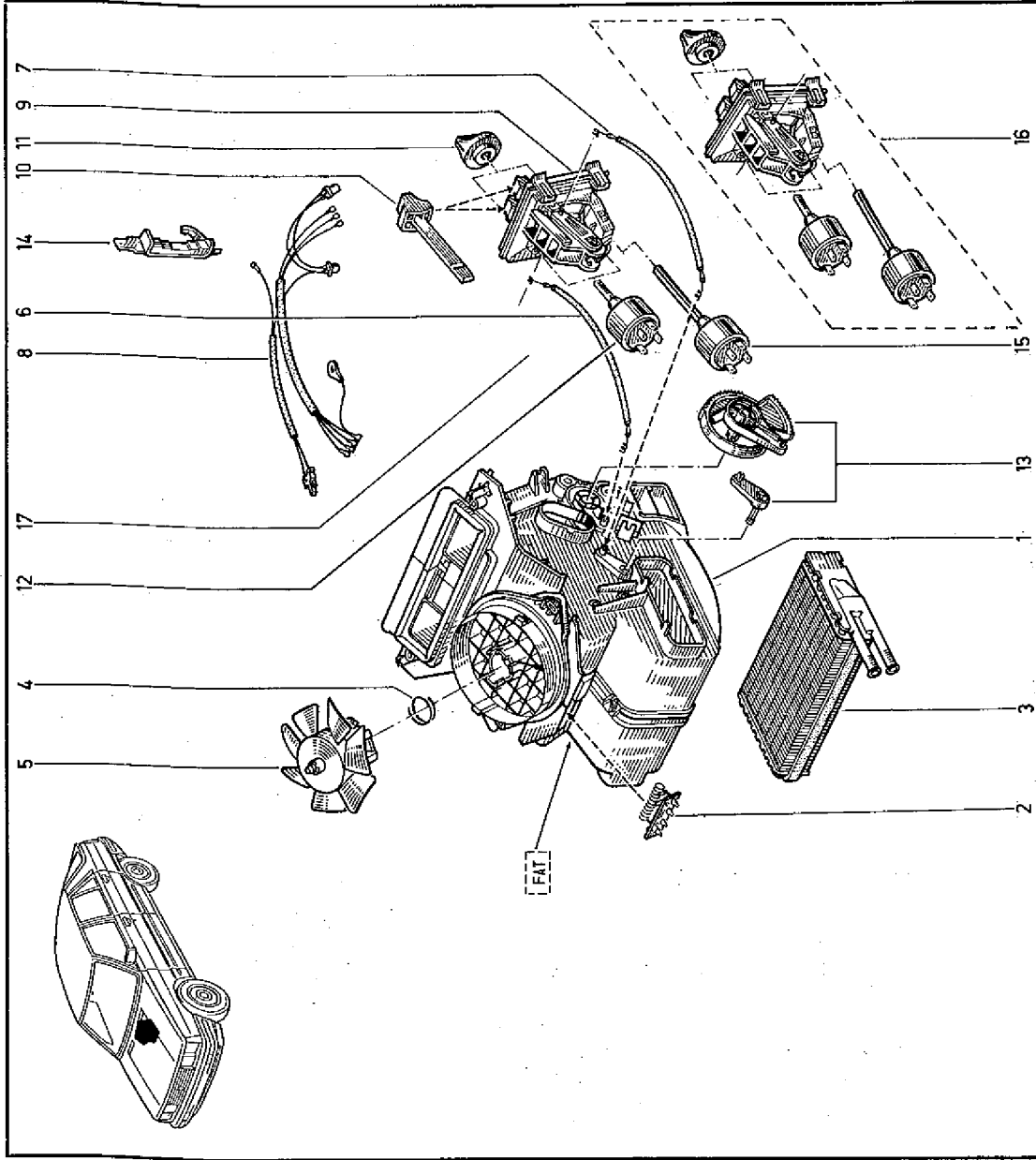

B37E	↑	n° 002942	↑	n°
B373	↑	n° 027734	↑	n°
B375	↑	n° 000673	↑	n°
B37T	↑	n°	↑	n°

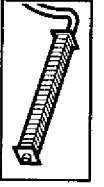

60.22
C.R.1037

- 1 - 77 02 088 740
- 2 - 77 02 088 752
- 3 - 77 02 088 742
- 4 - 77 02 088 743
- 5 - 77 02 088 750
- 6 - 77 02 088 744+
- 7 - 77 02 088 745
- 8 - 77 02 088 748
- 9 - 77 02 088 751
- 10 - 77 02 088 749
- 11 - 77 02 088 746
- 12 - 77 02 088 747
- 13 - 77 02 088 741



60.22
C.R.1037

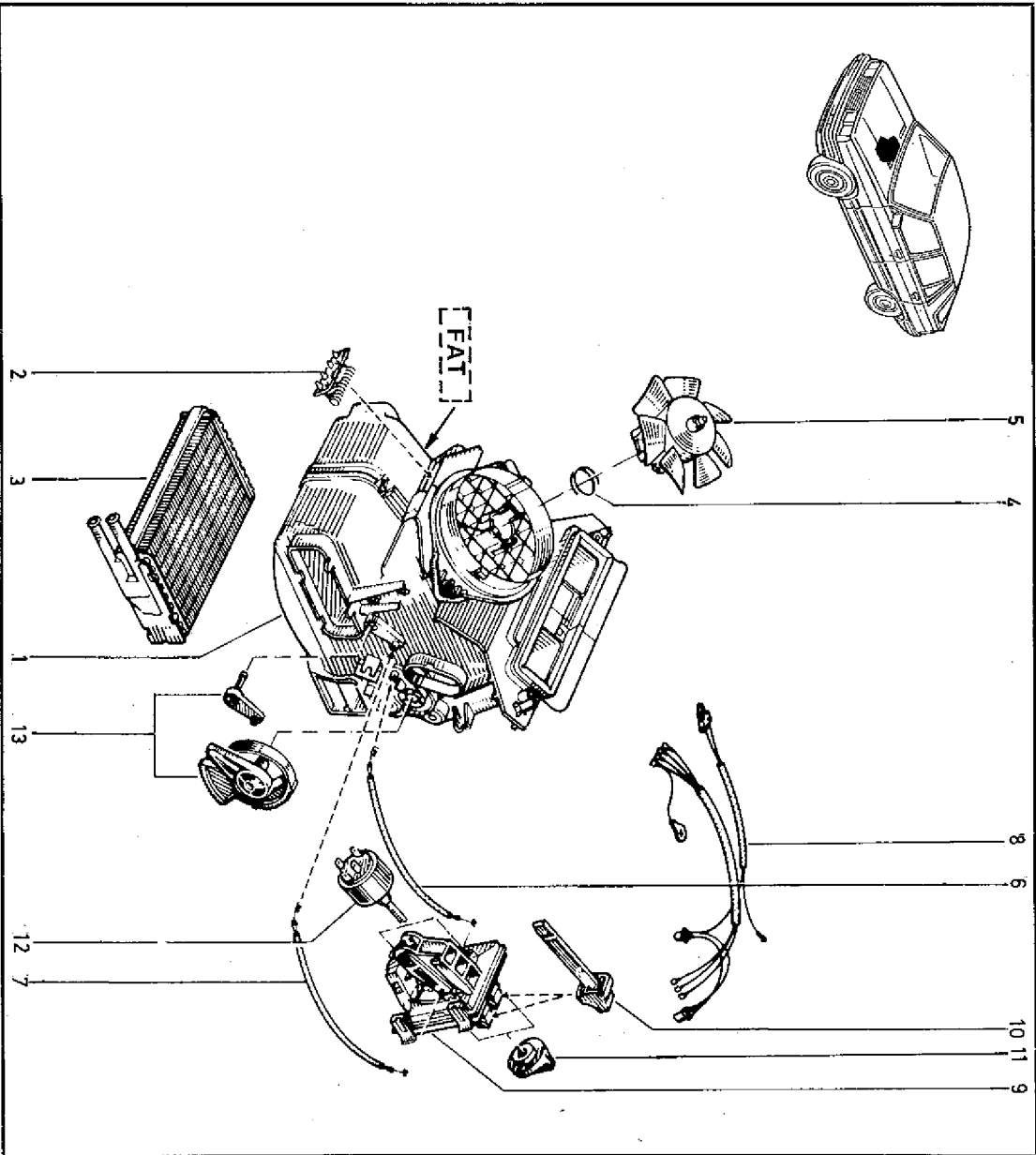
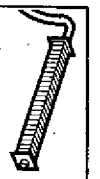

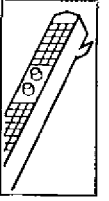

- 1 - 77 01 201 661
- 2 - 79 03 016 001
- 3 - 77 01 027 053
- 4 - 77 01 029 308 +
- 77 01 027 052

60.25
C.R.H037

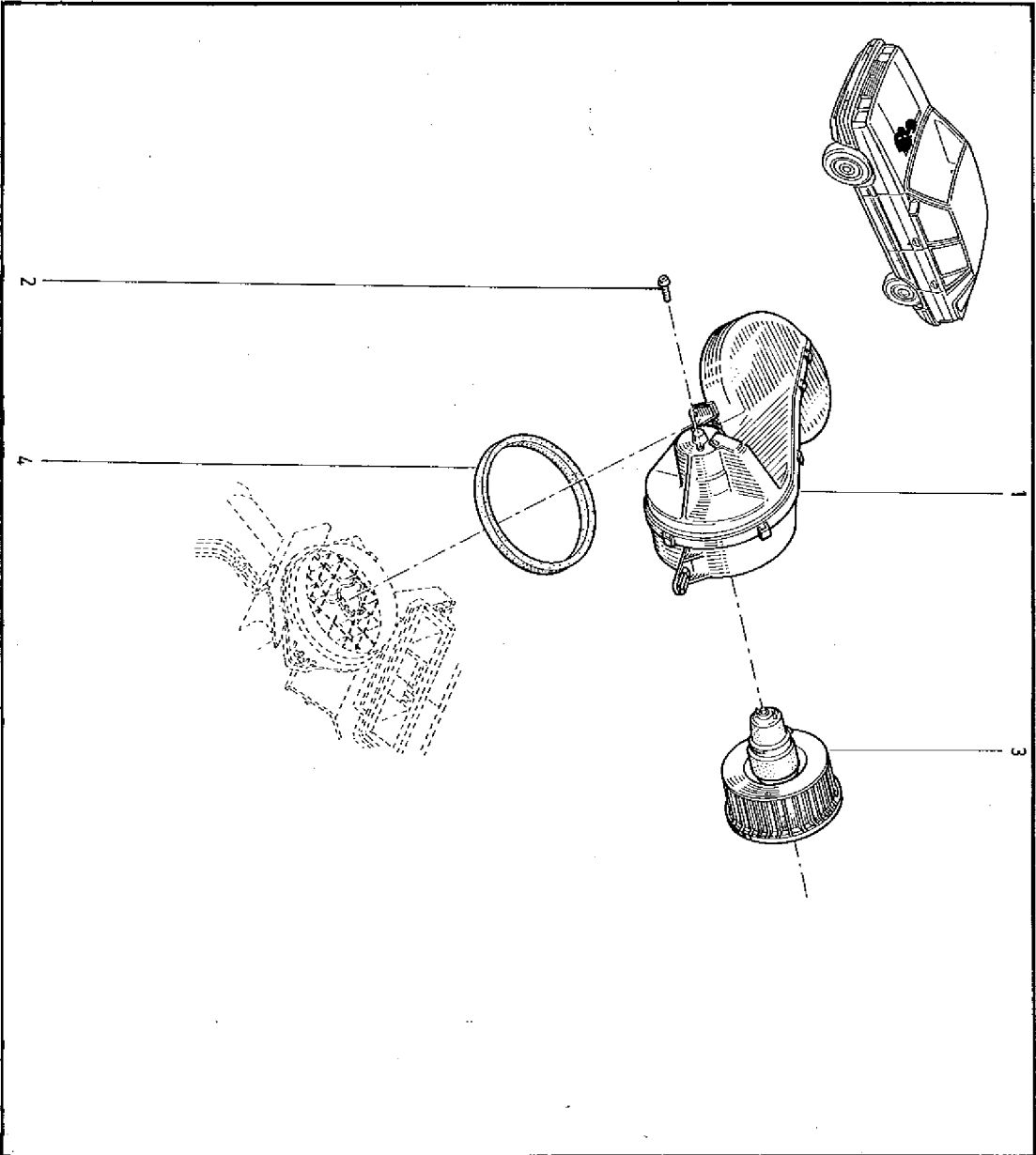

60.25
C.R.H037

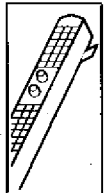

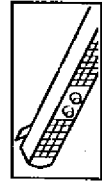

60.25.1
C.R. 1037

- 1-77 02 206 190
- 2-77 02 206 191
- 3-77 02 206 189
- 4-77 01 027 052



60.25.1
C.R. 1037

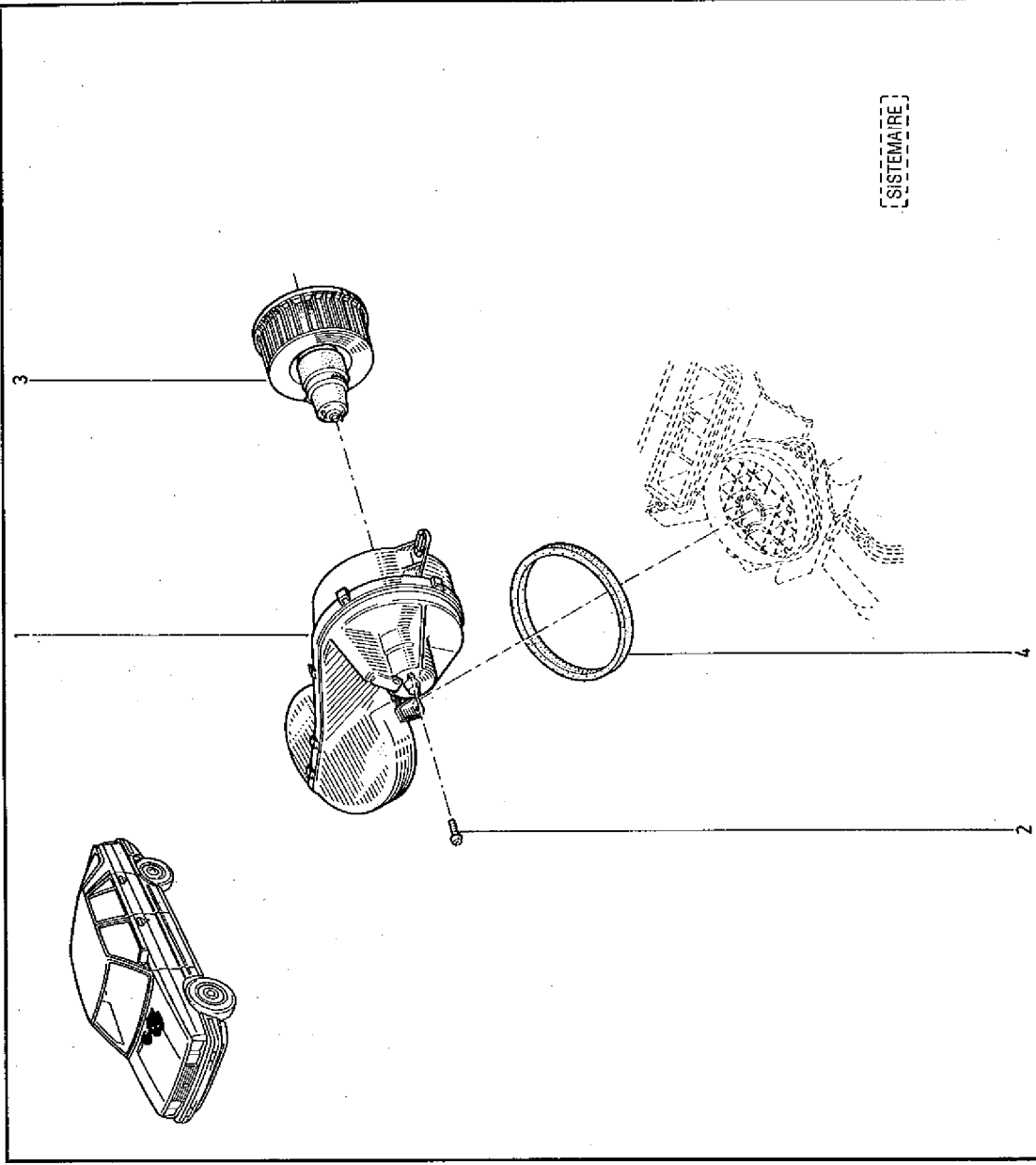
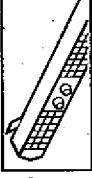

SISTEMAIRE

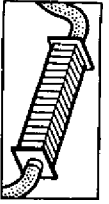

61.01
C.R.1037

- 1 - 77 00 762 481
- 2 - 77 00 762 572
- 3 - 77 00 691 486
- 4 - 77 03 081 056
- 5 - 77 03 079 236
- 6 - 77 00 754 131 +
- 7 - 77 03 101 042
- 8 - 77 03 055 007
- 9 - 79 03 032 009
- 10 - 09 90 009 100
- 11 - 77 02 025 817
- 12 - 77 03 081 064
- 13 - 77 00 515 140

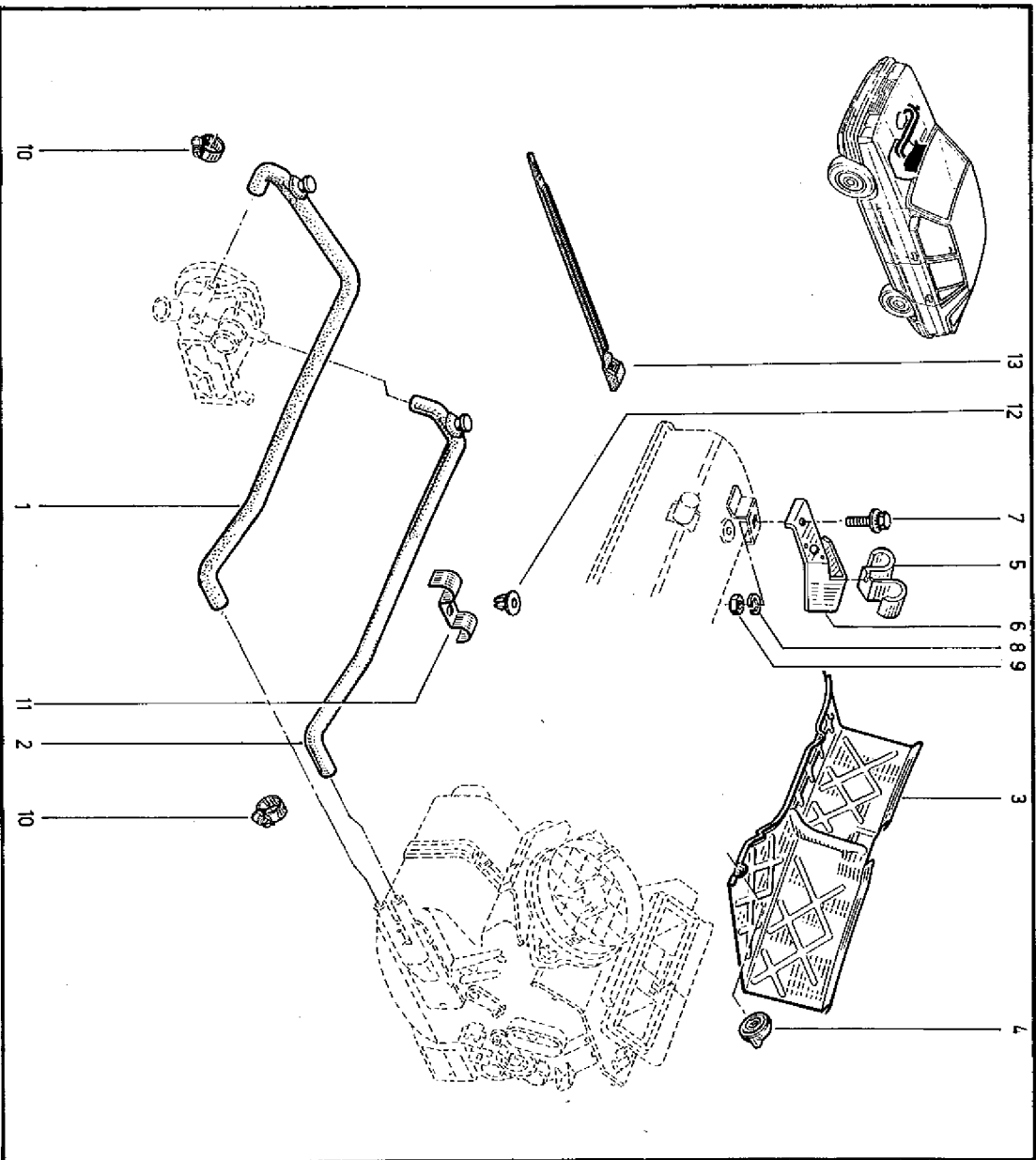

61.01
C.R.1037

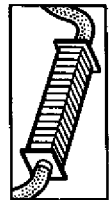

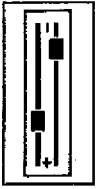

61 20
C.R.1037

- 1 - 77 02 082 827
- 2 - 77 02 085 058 $s < 1m$
- 3 - 77 00 766 661
- 4 - 77 01 596 841
- 5 - 77 04 000 008
- 6 - 77 02 082 824
- 7 - 77 00 672 304
- 8 - 77 00 771 793
- 9 - 77 03 078 116
- 10 - 77 03 072 050
- 11 - 77 05 026 167 +
- 12 - 77 02 085 209 (B = 375)

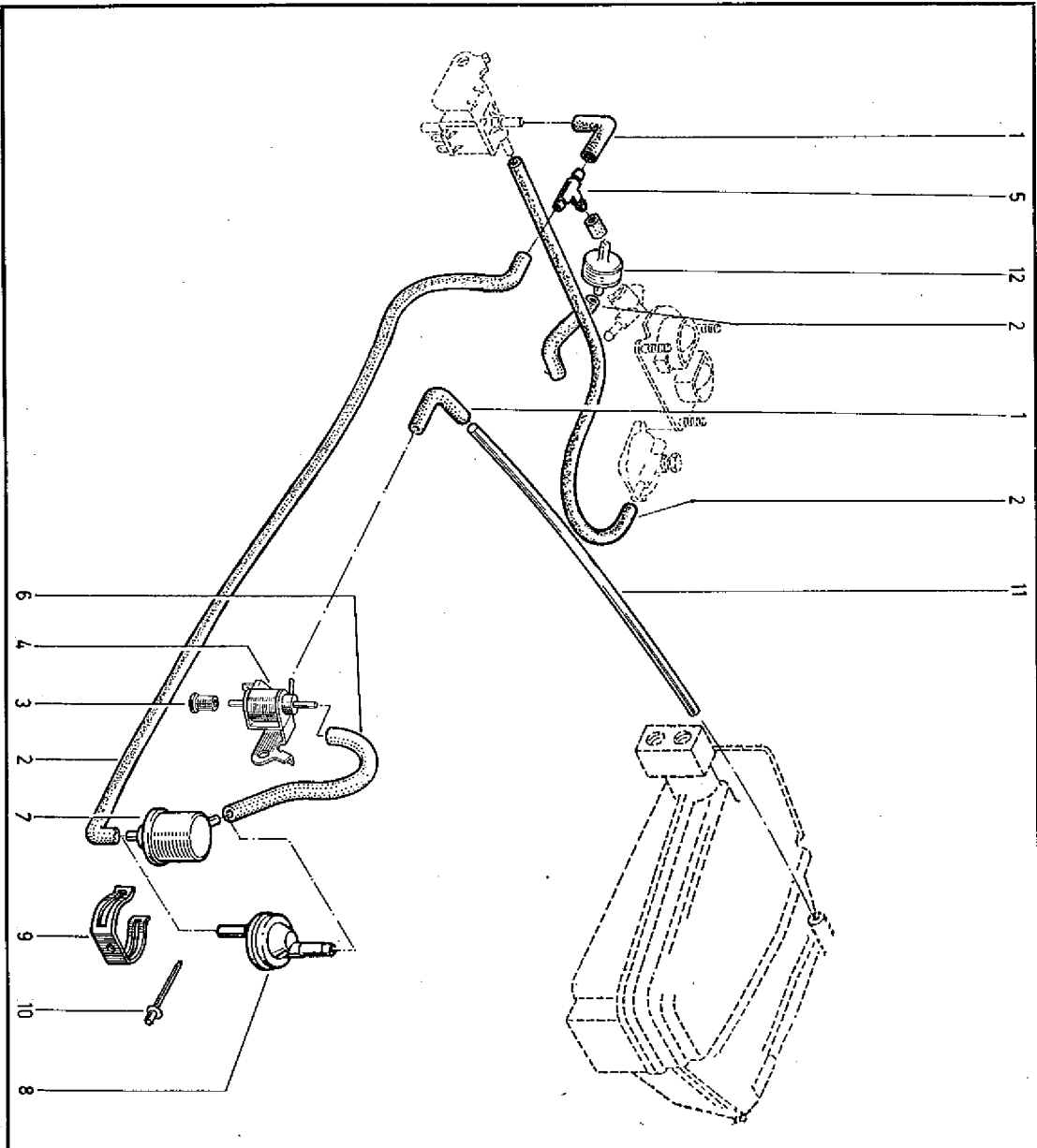

61 20
C.R.1037



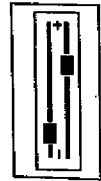

61.20.1
C.R.1037

- 1 - 77 00 654 476
- 77 02 072 739
- 77 00 768 332
- 3 - 77 00 766 661
- 4 - 77 00 000 008
- 5 - 77 03 079 070
- 6 - 77 02 082 62C
- 7 - 77 05 026 167
- 77 05 026 659
- 8 - 77 02 085 058 1 R
- 9 - 77 05 026 255 1 R
- 10 - 77 02 082 628
- 11 - 77 00 778 001



61.20.1
C.R.1037

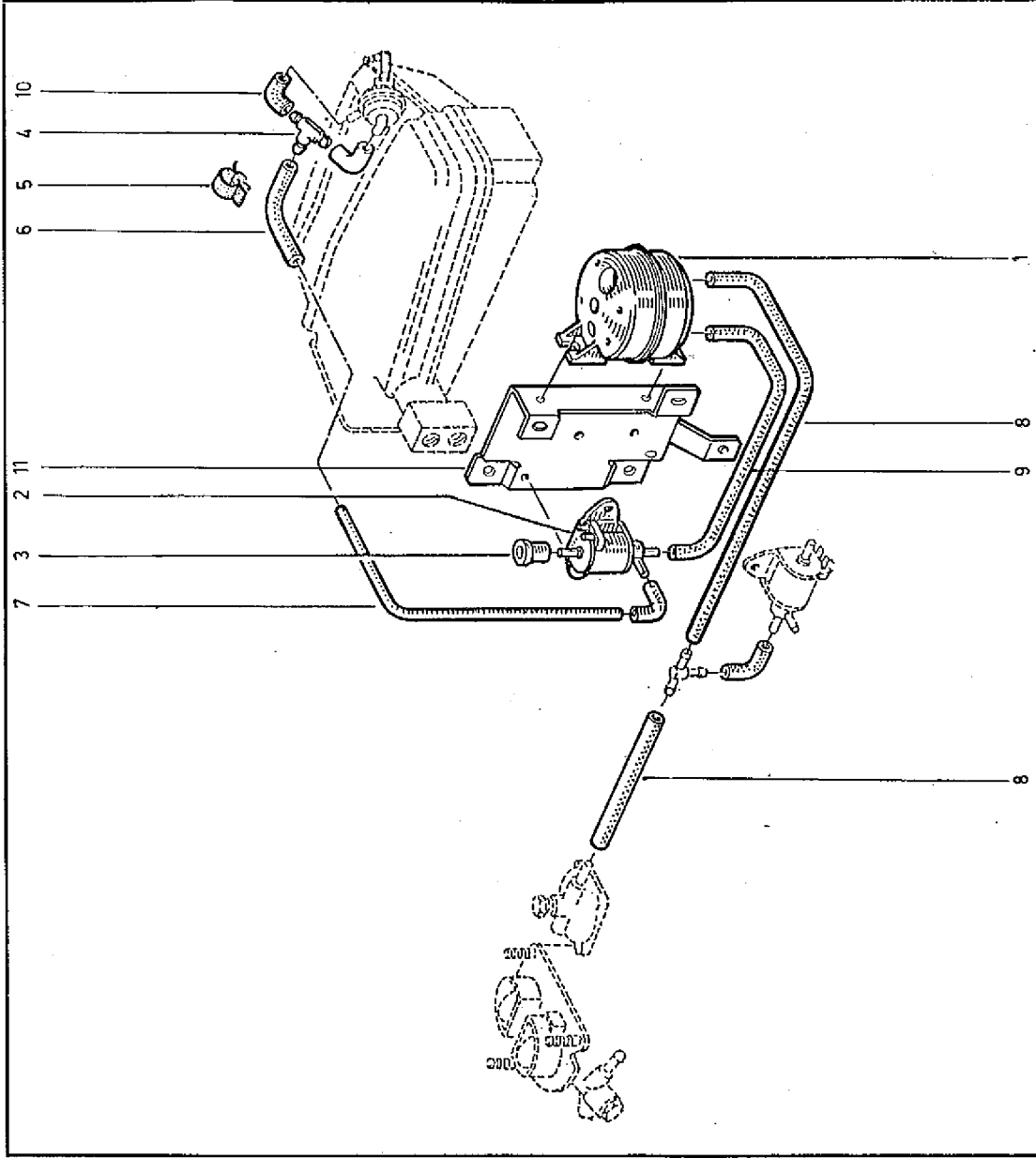

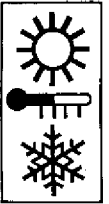

62.30
C.R.1037

- 1 - 77 01 201 999
- 2 - 77 01 028 220
- 3 - 77 01 030 250
- 4 - 77 01 029 549
- 5 - 77 01 029 201
- 6 - 77 08 016 304
- 7 - 77 01 031 443

B 37E		n°	1 →	n° 03392
B 373		n°	1 →	n° 29843
B 375		n°	1 →	n° 00699

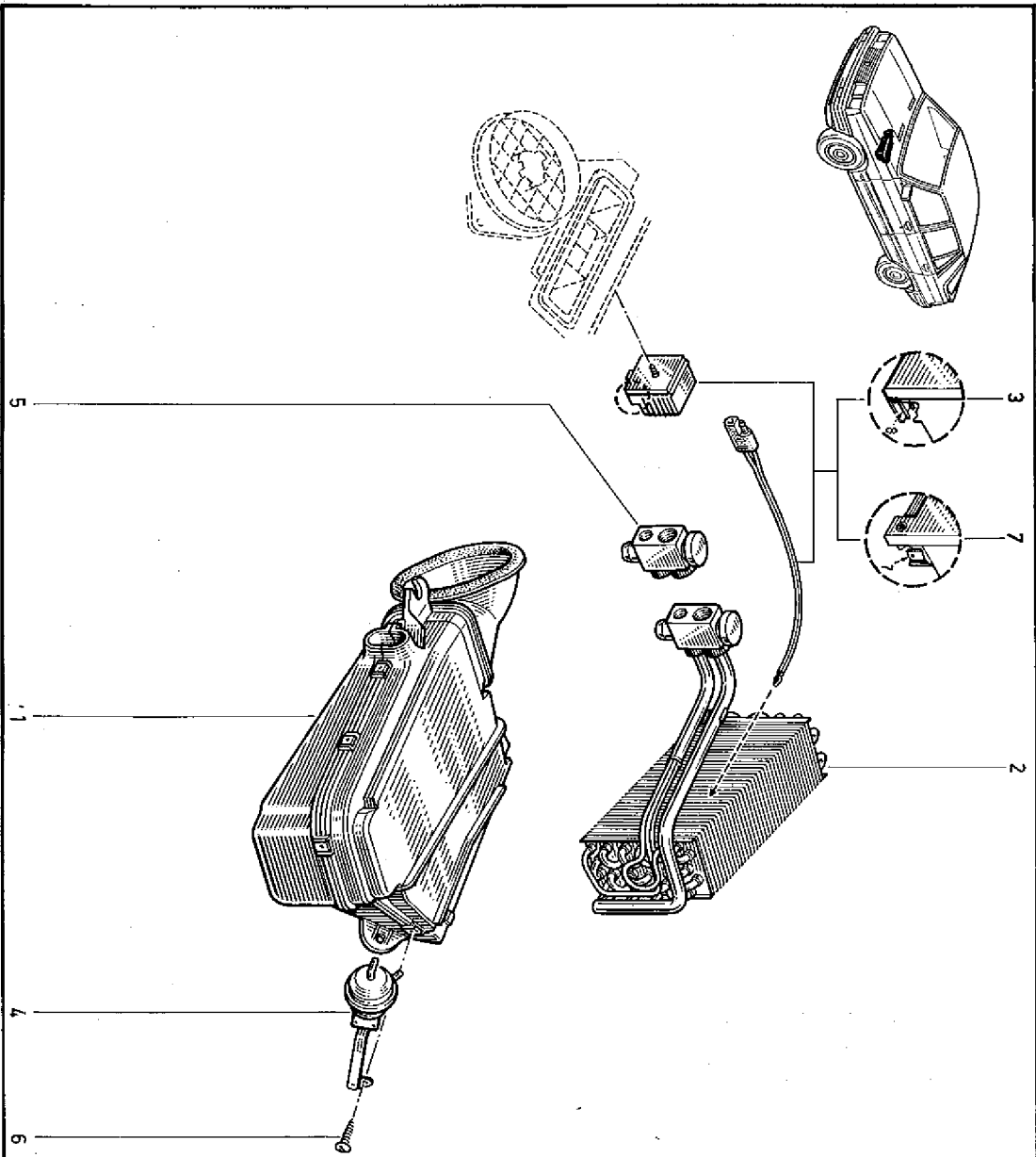

62.30
C.R.1037

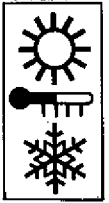

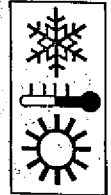

62.30.1
C.R.1037

- 1-77 02 206 167 (B)
- 77 02 206 186 (A)
- 2-77 02 206 141 (B)
- 77 02 206 183 (A)
- 3-77 02 206 172 (B)
- 77 02 206 188 (A)
- 4-77 02 206 168 (B)
- 77 02 206 185 (A)
- 5-77 02 206 142 (B)
- 77 02 206 184 (A)
- 6-77 02 206 169

62.30.1
C.R.1037

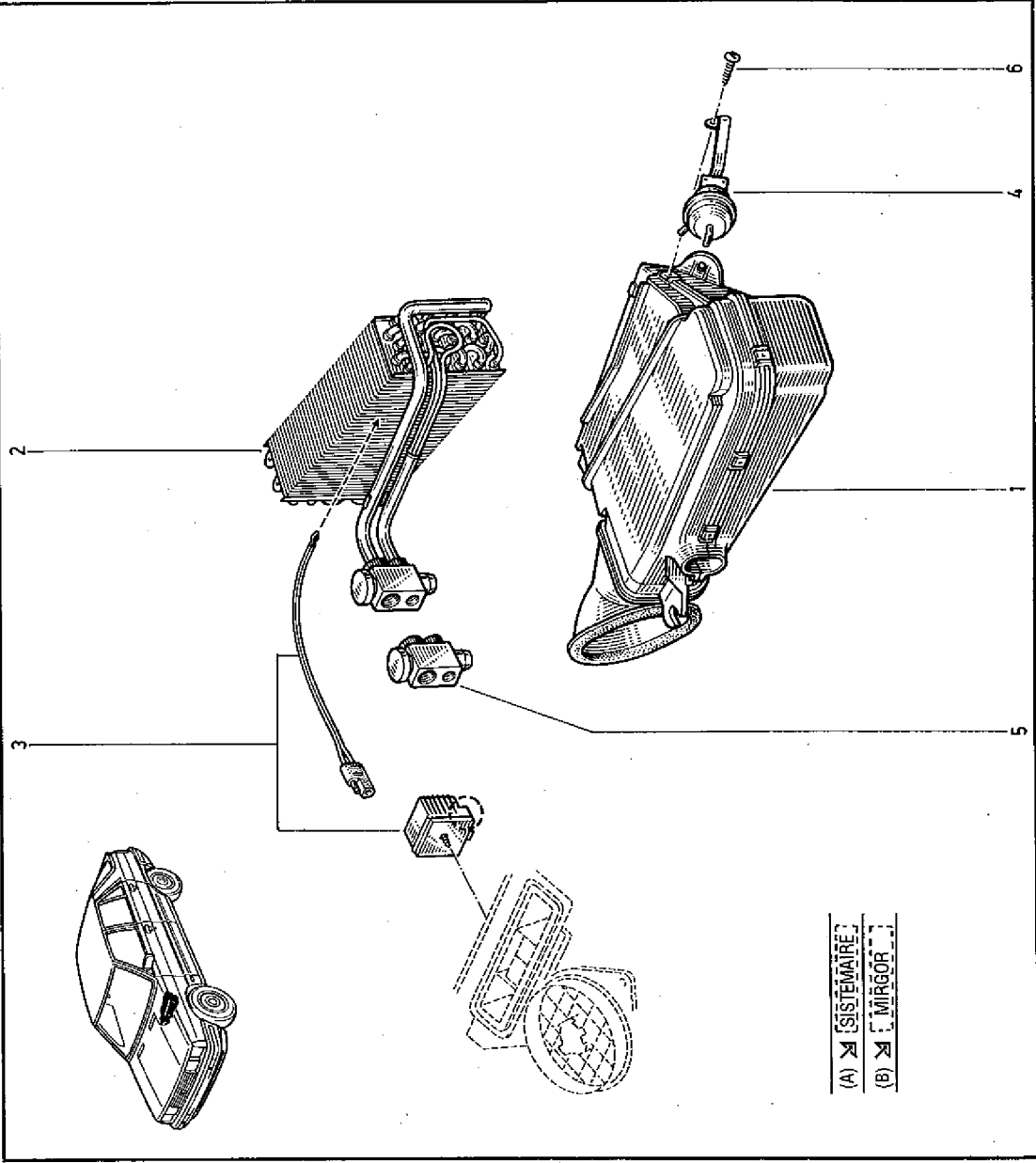
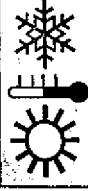

B37E	→	n° 03393	→	n°
B37B	→	n° 29844	→	n°
B37S	→	n° 00700	→	n°
B37T	→	n° 1	→	n°

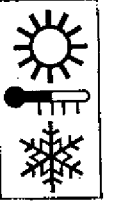

62.35
C.R.1037



8

62.35
C.R.1037

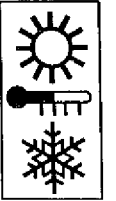

- 1 - 77 00 756 672
- 2 - 77 02 082 744
- 3 - 77 04 001 288
- 4 - 77 00 711 904
- 5 - 77 02 072 738
- 6 - 77 00 695 994
- 7 - 77 03 072 050
- 8 - 77 00 757 554
- 9 - 77 00 715 920
- 10 - 77 05 005 028
- 11 - 77 03 033 009
- 12 - 77 00 692 907
- 13 - 77 02 082 743
- 14 - 77 03 065 122
- 15 - 77 03 065 121
- 16 - 77 03 065 120
- 17 - 77 00 711 902
- 18 - 77 00 711 903
- 19 - 77 00 752 055
- 20 - 77 00 711 846
- 21 - 77 03 008 001
- 22 - 77 03 033 015

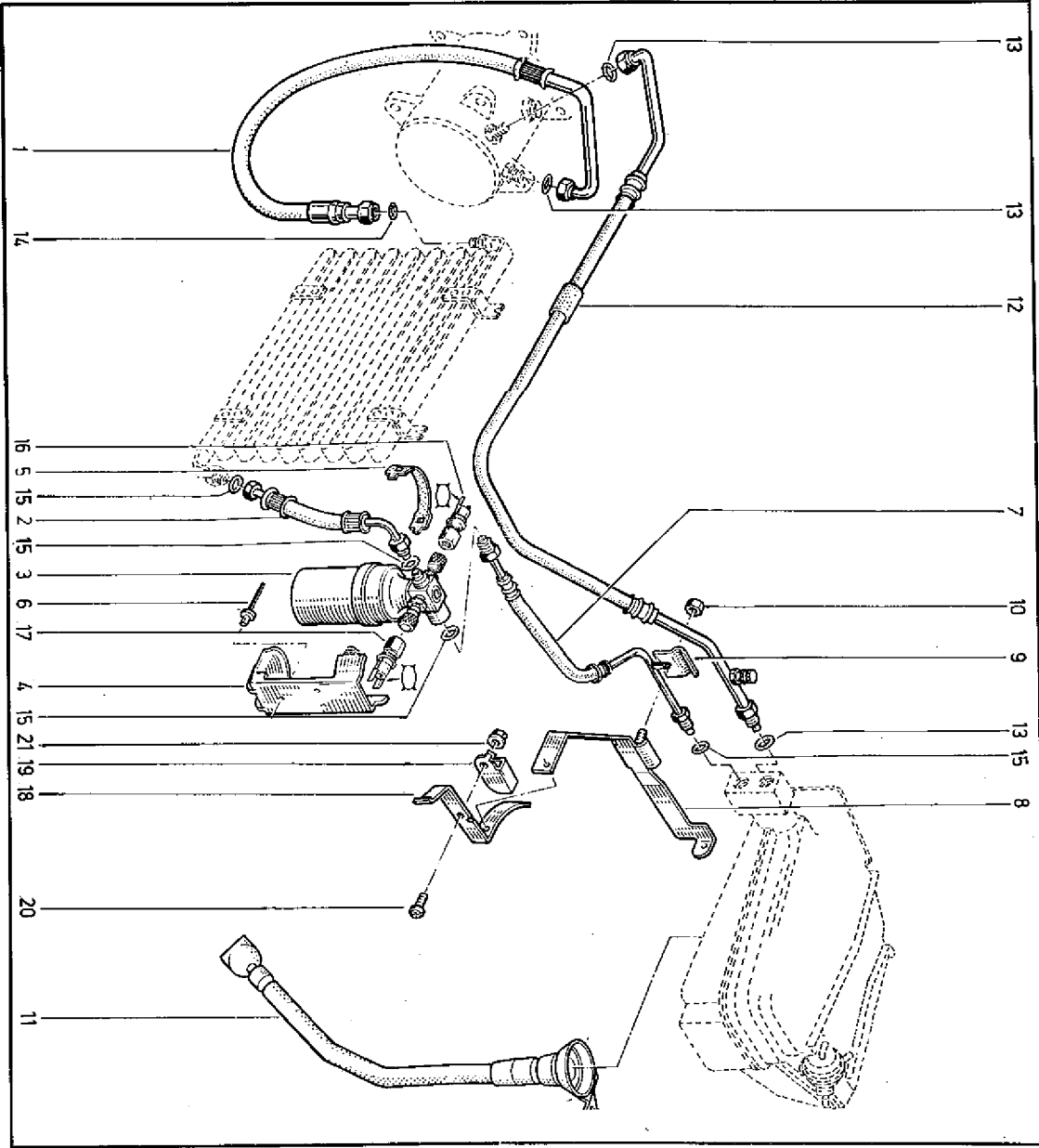

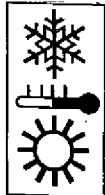

62.35.1
C.R.1037



62.35.1
C.R.1037

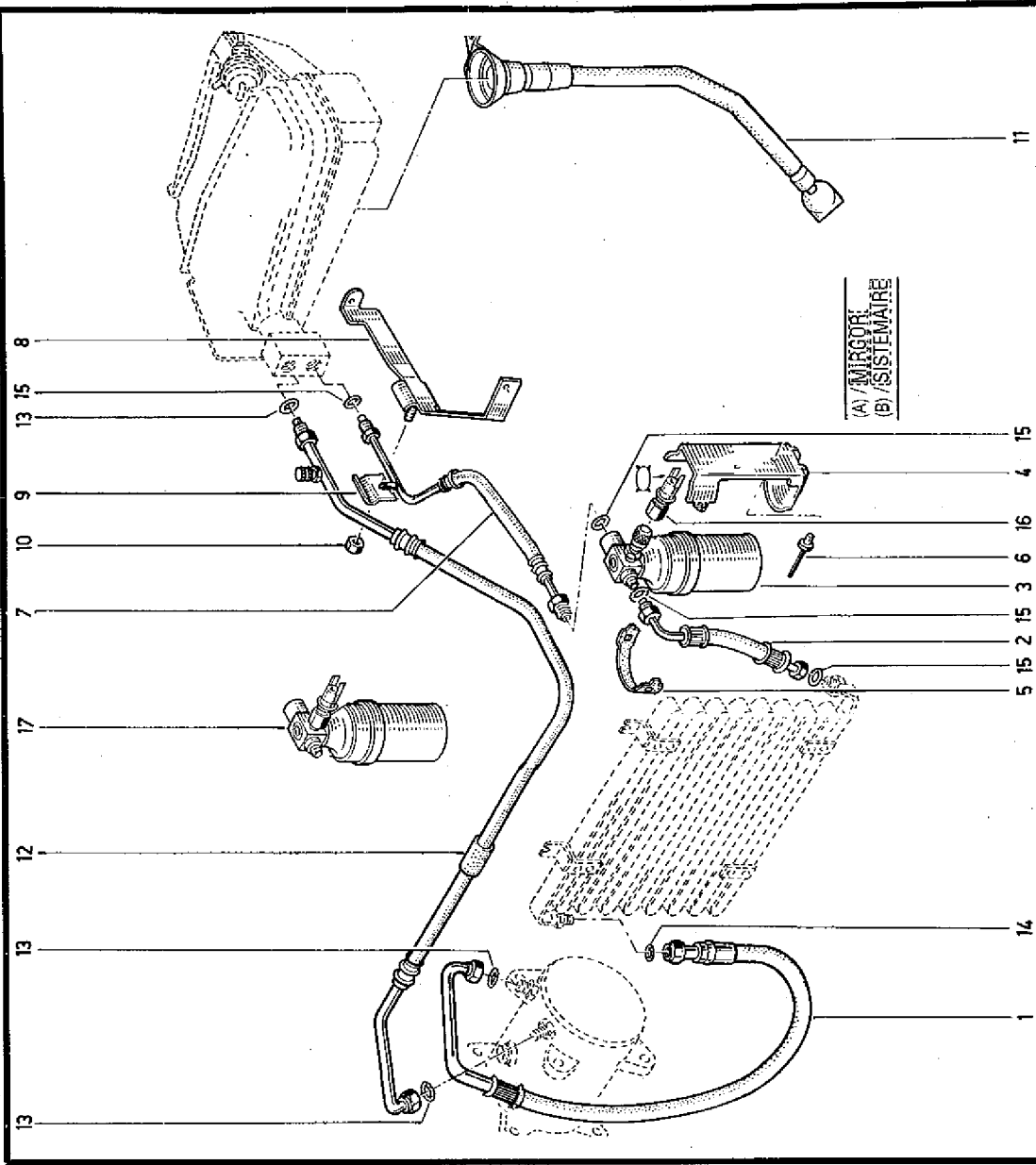
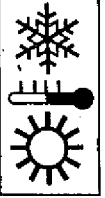

- 1- 77 02 082 859 (A) (E)
- 77 02 082 866 (B) (E)
- 77 02 082 860 (A) (E)
- 77 02 082 867 (B) (E)
- 2- 77 02 082 861 (A)
- 77 02 082 868 (B)
- 3- 77 02 206 040 (B)
- 4- 77 00 695 994
- 5- 77 00 695 993
- 6- 77 03 072 050
- 7- 77 02 082 862 (A)
- 77 02 082 869 (B)
- 8- 77 00 715 920
- 9- 77 05 005 028
- 10- 77 03 033 009
- 11- 77 00 692 907
- 12- 77 02 082 863 (A) (E)
- 77 02 082 870 (B) (E)
- 77 02 082 864 (A) (E)
- 77 02 082 871 (B) (E)
- 13- 77 03 065 122
- 14- 77 03 065 121
- 15- 77 03 065 120
- 16- 77 02 206 041 (B)
- 17- 77 02 099 278 (B)
- 77 02 082 876 (A)

B 373	→	n° 32693
B 37E	→	n° 1055
B 375	→	n° 811



64.01
C.R.1037

- 1 - 77 03 074 073
- 2 - 77 03 074 191
- 3 - 77 00 674 884
- 4 - 77 00 682 856 +
- 77 02 081 700
- 5 - 77 00 752 671
- 6 - 77 00 686 136
- 7 - 77 03 016 013
- 8 - 77 04 001 548
- 9 - 77 00 659 817 + ○
- 77 00 518 546
- 10 - 77 00 759 978
- 11 - 77 03 088 055
- 12 - 77 03 088 048
- 13 - 77 01 026 890 s< 1m.
- 14 - 77 01 026 892
- 15 - 77 01 026 984 +
- 77 00 774 647
- 16 - 77 00 641 938 (a)
- 17 - 77 00 689 937 (a)
- 18 - 77 04 003 263
- 19 - 77 03 074 071
- 20 - 77 04 003 693
- 21 - 77 04 001 767
- 22 - 77 04 001 788
- 23 - 77 04 002 483
- 24 - 77 00 717 627
- 25 - 77 03 074 035
- 26 - 77 02 081 472
- 27 - 77 03 074 078
- 28 - 77 03 073 059

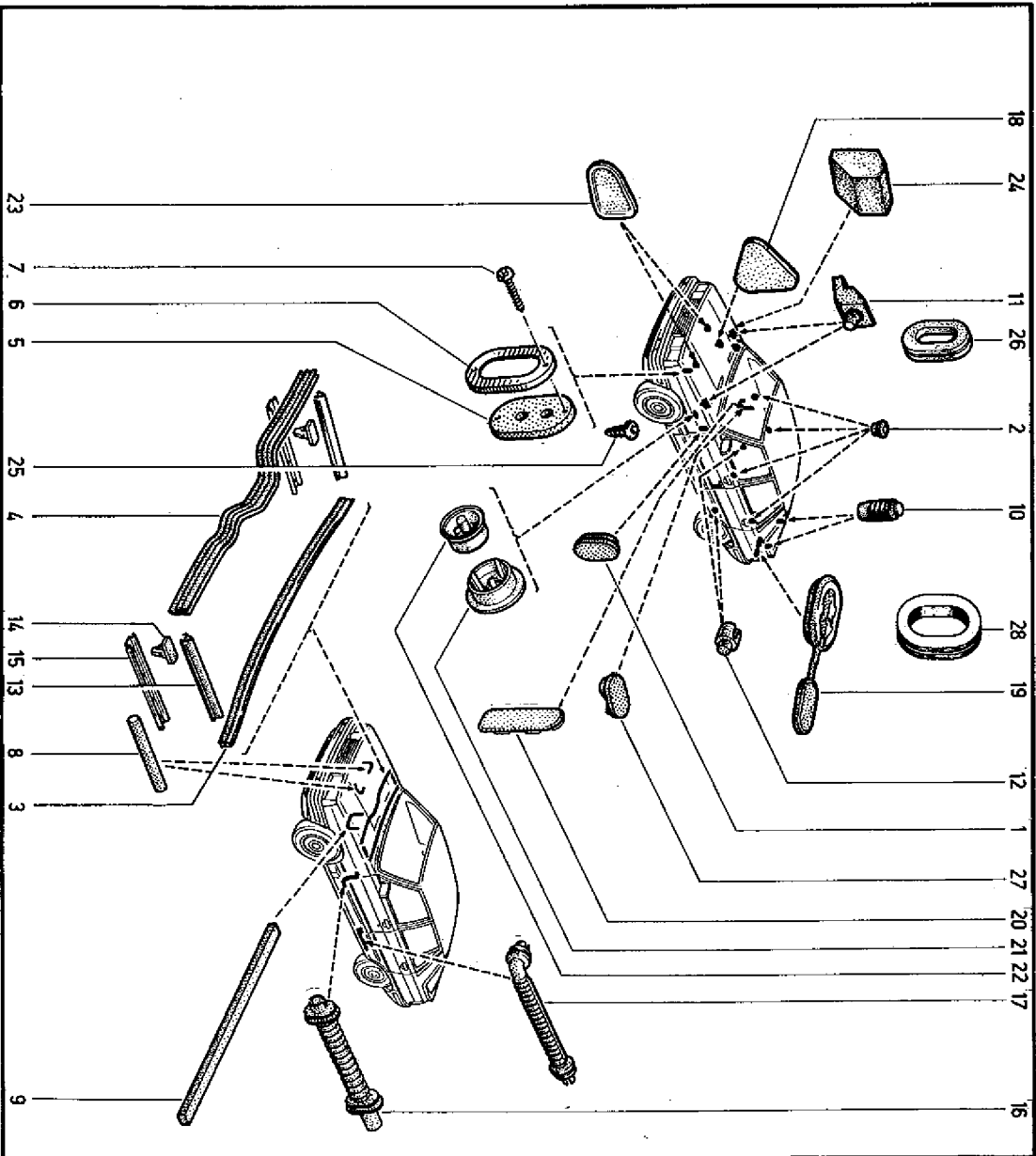

64.01
C.R.1037



(a) / 8373

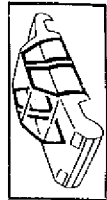

65.01
C.R.1037

- 1 - 77 00 682 768 †
- 77 00 760 898 †
- 77 02 081 708
- 2 - 77 00 682 769 †
- 77 00 760 899 †
- 77 02 081 707
- 3 - 77 00 756 928
- 4 - 77 04 000 822
- 5 - 77 04 000 796
- 6 - 77 04 001 449
- 7 - 77 00 682 242
- 8 - 77 02 081 409 (a)
- 77 02 081 769 (b)
- 77 02 081 840 (c)

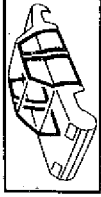

65.01
C.R.1037

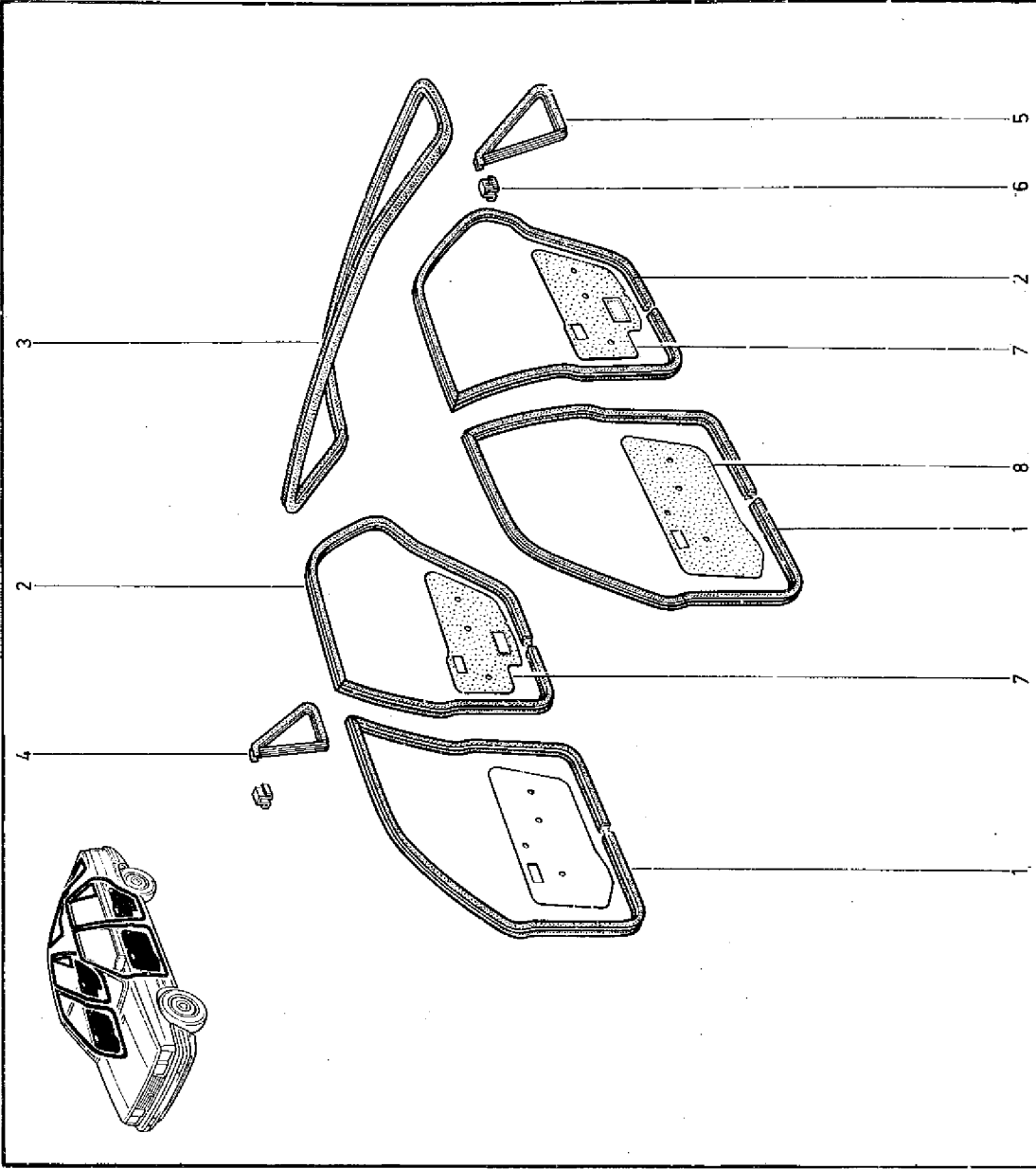

B37E	†	†	†	†	†	†	†
B37G	†	†	†	†	†	†	†
B37H	†	†	†	†	†	†	†
B37I	†	†	†	†	†	†	†
B37J	†	†	†	†	†	†	†
B37K	†	†	†	†	†	†	†
B37L	†	†	†	†	†	†	†
B37M	†	†	†	†	†	†	†
B37N	†	†	†	†	†	†	†
B37O	†	†	†	†	†	†	†
B37P	†	†	†	†	†	†	†
B37Q	†	†	†	†	†	†	†
B37R	†	†	†	†	†	†	†
B37S	†	†	†	†	†	†	†
B37T	†	†	†	†	†	†	†
B37U	†	†	†	†	†	†	†
B37V	†	†	†	†	†	†	†
B37W	†	†	†	†	†	†	†
B37X	†	†	†	†	†	†	†
B37Y	†	†	†	†	†	†	†
B37Z	†	†	†	†	†	†	†



66.01
C.R.1037

- 1 - 77 00 682 240
- 2 - 77 04 001 747
- 3 - 77 00 751 515
- 4 - 77 08 077 185
- 5 - 77 00 691 094
- 6 - 77 01 349 597 +
- 7 - 77 03 682 247 (b)
- 8 - 77 00 682 620 (a)
- 9 - 77 00 682 250
- 10 - 77 01 349 598 +
- 11 - 77 00 682 235
- 12 - 77 01 349 600
- 13 - 77 00 682 244
- 14 - 77 00 691 096 (b)
- 15 - 77 00 691 142 (a)
- 16 - 77 01 349 599 +
- 17 - 77 00 682 245
- 18 - 77 00 682 248 (b)
- 19 - 77 00 682 621 (a)
- 20 - 77 04 001 415
- 21 - 77 04 000 335

(a) B372
(b) B373

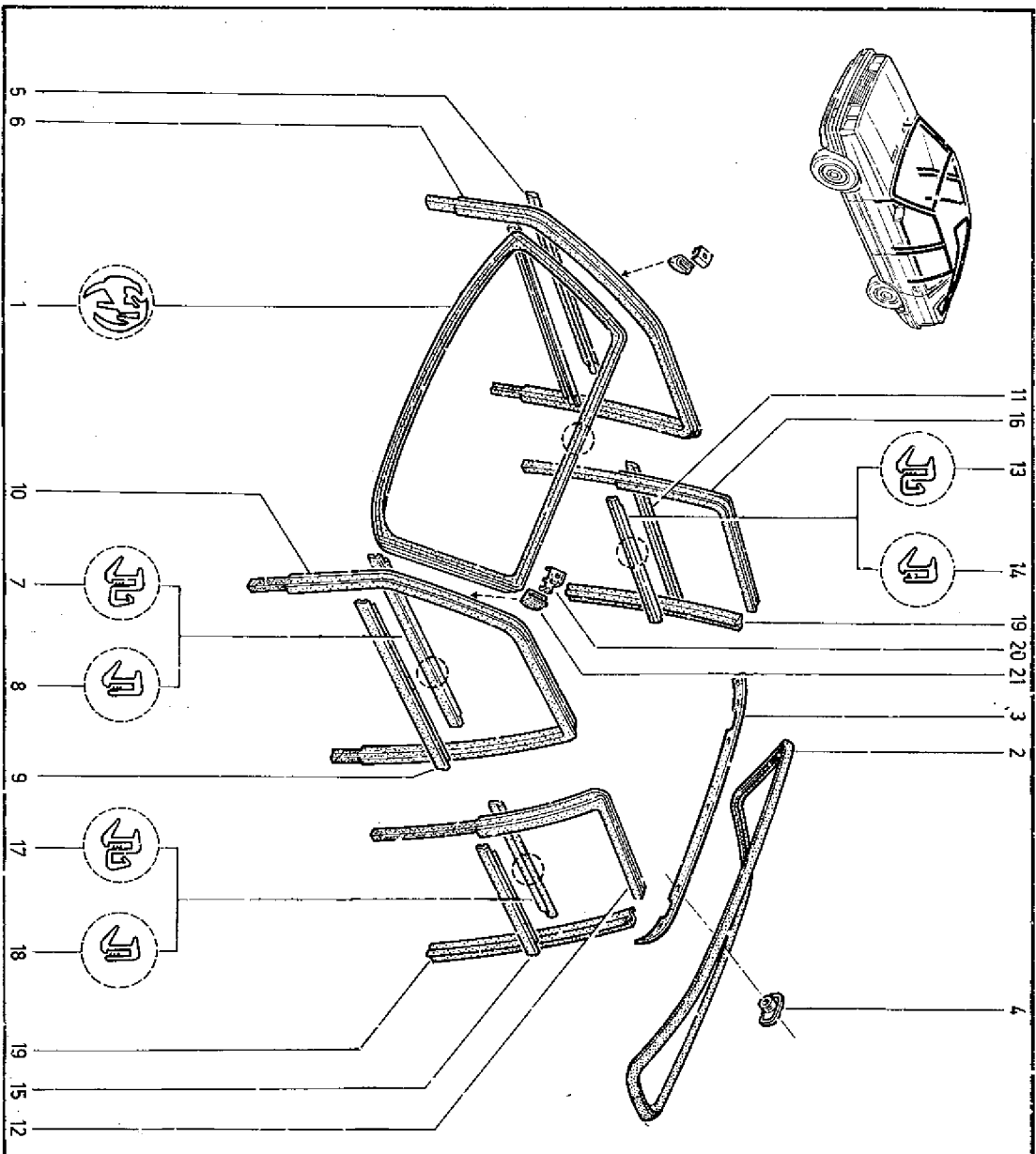

66.01
C.R.1037





68.01
C.R.1037

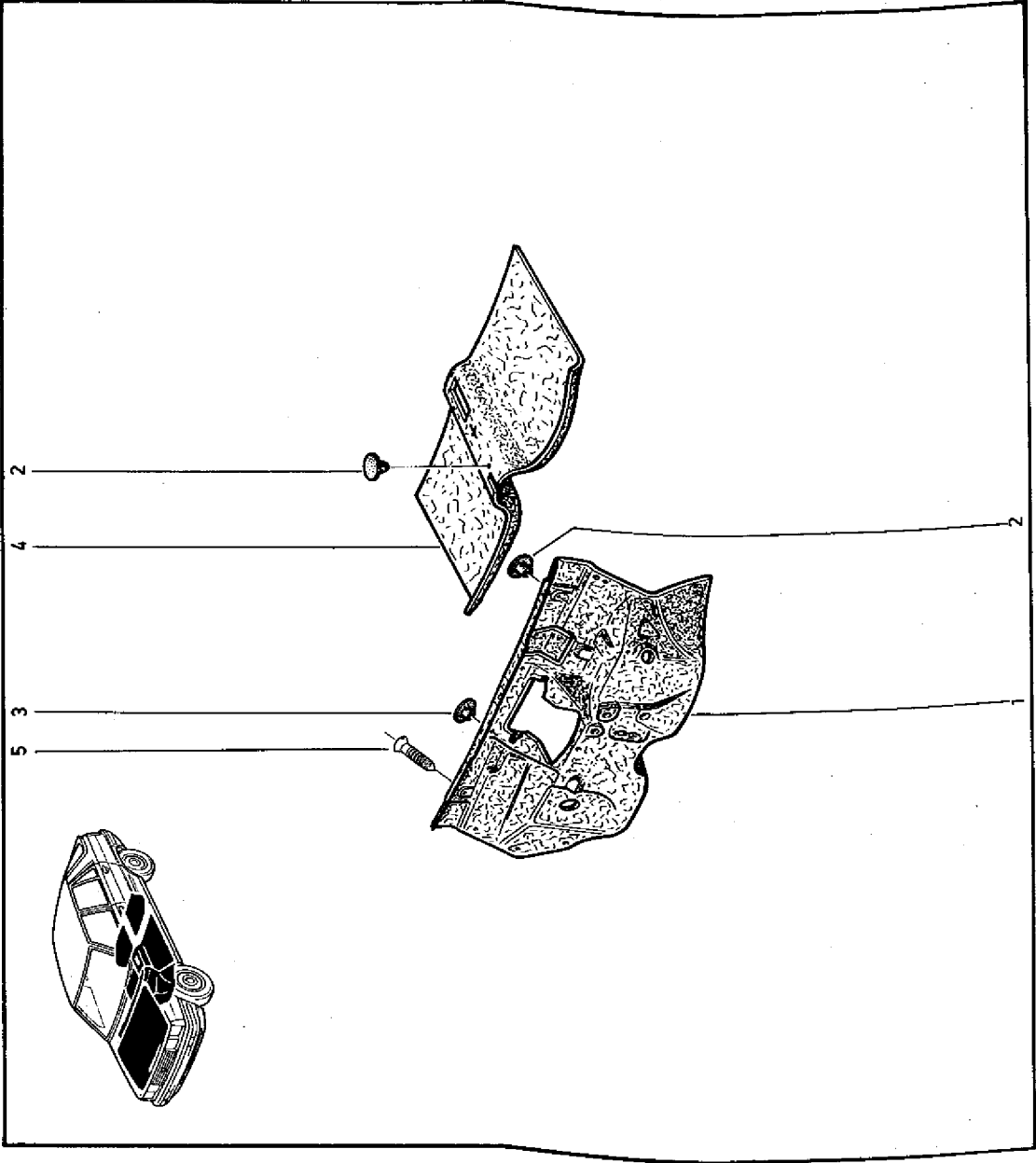

68.01
C.R.1037



- 1 - 77 00 694 394
- 2 - 77 03 081 054
- 3 - 77 03 077 110
- 4 - 77 00 684 686
- 5 - 79 03 016 030



69.01
01.89 C.R. 1087

- 1 - 77 02 082 151 (a) (a)
- 77 02 082 001 (a) (a)
- 77 02 082 794 (s) (e)
- 77 02 082 792 (a) (b)
- 77 02 082 793 (a) (b)
- 77 02 204 224 (s) (f)
- 77 02 204 698 (a) (c) (d)
- 77 02 204 699 (a) (c) (d)
- 77 02 204 700 (a) (e)
- 77 02 204 701 (a) (e)
- 77 02 204 307 (a) (e) (f)

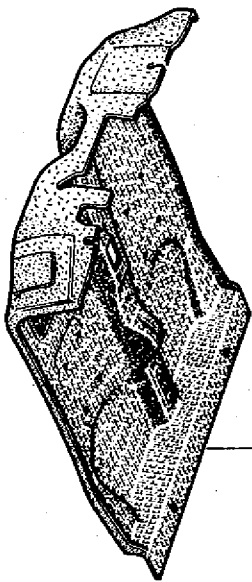
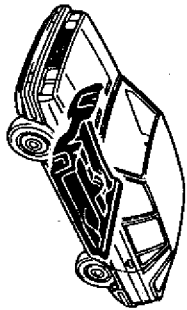

69.01
C.R. 1087



(a)	B-372	1	MOD - 8609
	B-373	1	16883
	B-373	1	16884
	B-373	1	30733
(b)	B-376	1	6620
	B-37E	1	

(c)	B-376	1	6621
(e)	B-371	1	
(d)	B-373	1	30734
(e)	B-375	1	731
(f)	B-375	1	732



71.01
C.R.1037

- 1 - 77 00 712 822 (2-0)
- 77 03 682 284 (2-3)
- 77 02 204 716 (2-0)
- 2 - 77 00 712 809 (2-0) (a)
- 77 00 702 940 (2-0) (b)
- 77 00 692 381 (2-0) (a)
- 77 00 682 286 (2-0) (b)
- 77 02 204 719 (2-0) (c)
- 3 - 77 00 707 721 (2-0)
- 77 00 707 723 (2-3)
- 77 02 204 642 (2-0)
- 4 - 77 00 712 818 (2-0)
- 77 00 683 295 (2-3)
- 77 02 204 720 (2-0)
- 5 - 77 00 708 045 (5-1)
- 77 00 708 047 (2-3)
- 6 - 77 00 705 445 (5-1)
- 77 00 682 522 (2-3)
- 7 - 77 00 712 821 (2-0)
- 77 00 682 283 (2-3)
- 77 02 082 211 (2-0)
- 77 02 082 210 (2-3)
- 77 02 204 715 (2-0)
- 8 - 77 00 702 939 (2-0)
- 77 00 682 285 (2-3)
- 77 02 082 209 (2-0)
- 77 02 082 208 (2-3)
- 9 - 77 00 707 720 (2-0)
- 77 00 707 722 (2-3)
- 77 02 204 643 (2-0)
- 10 - 77 00 712 817 (2-0)
- 77 00 683 294 (2-3)
- 77 02 204 721 (2-0)
- 11 - 77 00 708 044 (5-1)
- 77 00 708 046 (2-3)
- 12 - 77 00 705 444 (5-1)
- 77 00 680 394 (2-3)
- 13 - 77 03 016 026
- 14 - 77 03 076 112

(a) B.372 - B.37G
(b) B.373 - B.37I - B.37S
(c) B.373 - B.37T

71.01
C.R.1037

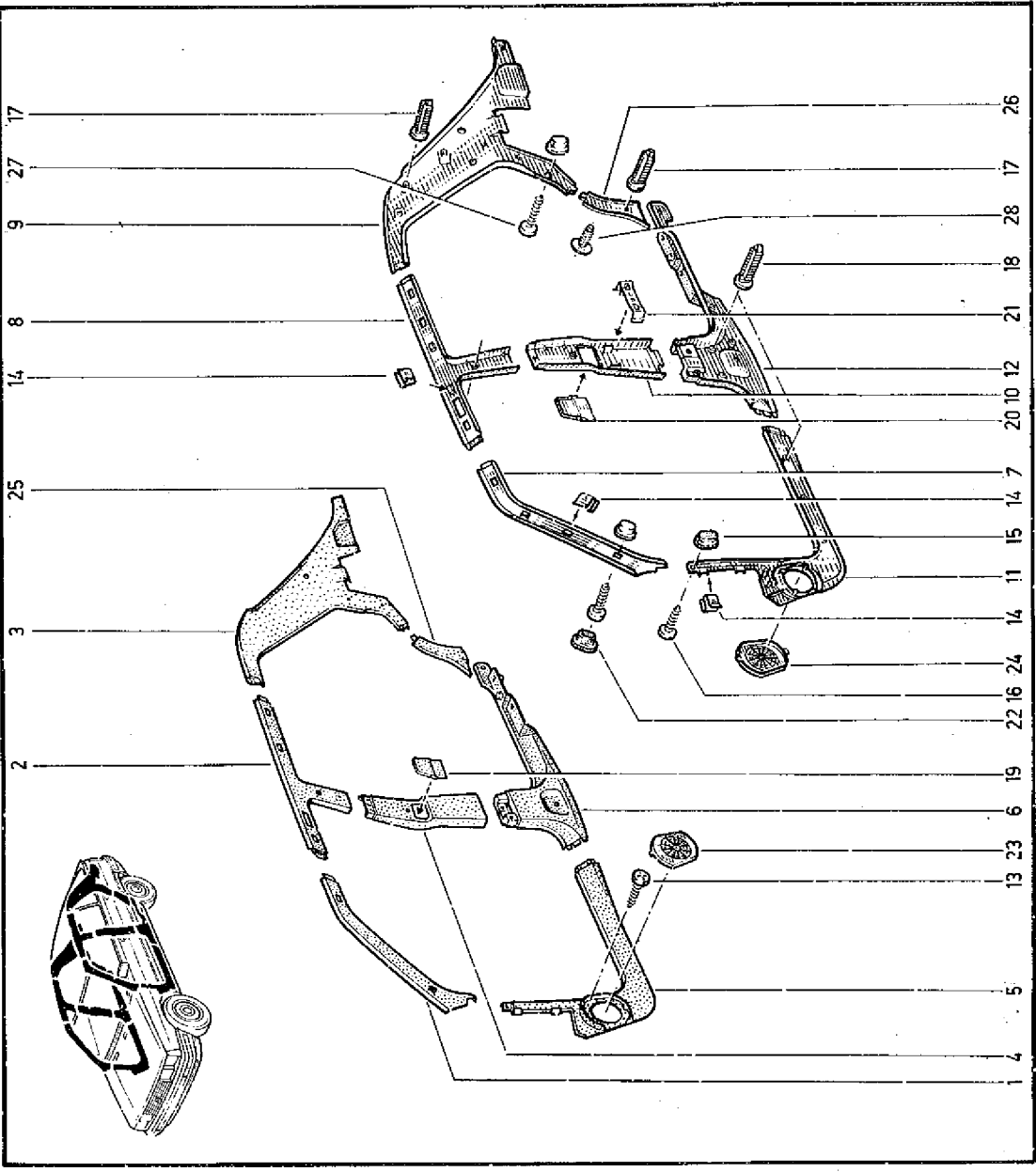

- 15 - 77 03 081 019
- 16 - 77 03 016 154
- 17 - 77 03 077 109
- 18 - 77 02 204 688 (2-0)
- 77 03 074 222 (2-0)
- 19 - 77 00 712 802 (2-0)
- 77 00 703 079 (2-3)
- 77 02 204 722 (2-0)
- 20 - 77 00 712 801 (2-0)
- 77 00 703 076 (2-3)
- 21 - 77 04 001 566
- 22 - 77 03 074 222 (2-0)
- 77 03 074 220 (2-3)
- 77 03 074 263 (2-0)
- 23 - 77 03 074 261 (2-3)
- 77 00 708 041 (5-1)
- 77 00 708 043 (2-3)
- 24 - 77 00 708 040 (5-1)
- 77 00 708 042 (2-3)
- 25 - 77 00 709 540 (2-0)
- 77 00 709 542 (2-3)
- 77 02 204 644 (2-0)
- 26 - 77 00 709 539 (2-0)
- 77 00 709 541 (2-3)
- 77 02 204 645 (2-0)
- 27 - 77 03 016 024
- 28 - 77 03 077 139 (2-0)
- 77 03 077 133 (2-3)



71.05
C.R.1037

- 1 - 77 00 710 626 (a)†
- 77 02 208 529 (c)
- 77 02 082 284 (b)†
- 77 02 208 528 (d)
- 77 02 097 548 +
- 2 - 77 00 709 860 (a)†
- 77 02 208 530 (c)
- 3 - 77 00 709 861 (a)†
- 77 02 208 531 (c)
- 4 - 77 03 077 068
- 5 - 77 00 711 901 (a)†
- 77 02 082 242 (a)†
- 6 - 77 03 081 051
- 7 - 77 03 081 050

71.05
C.R.1037

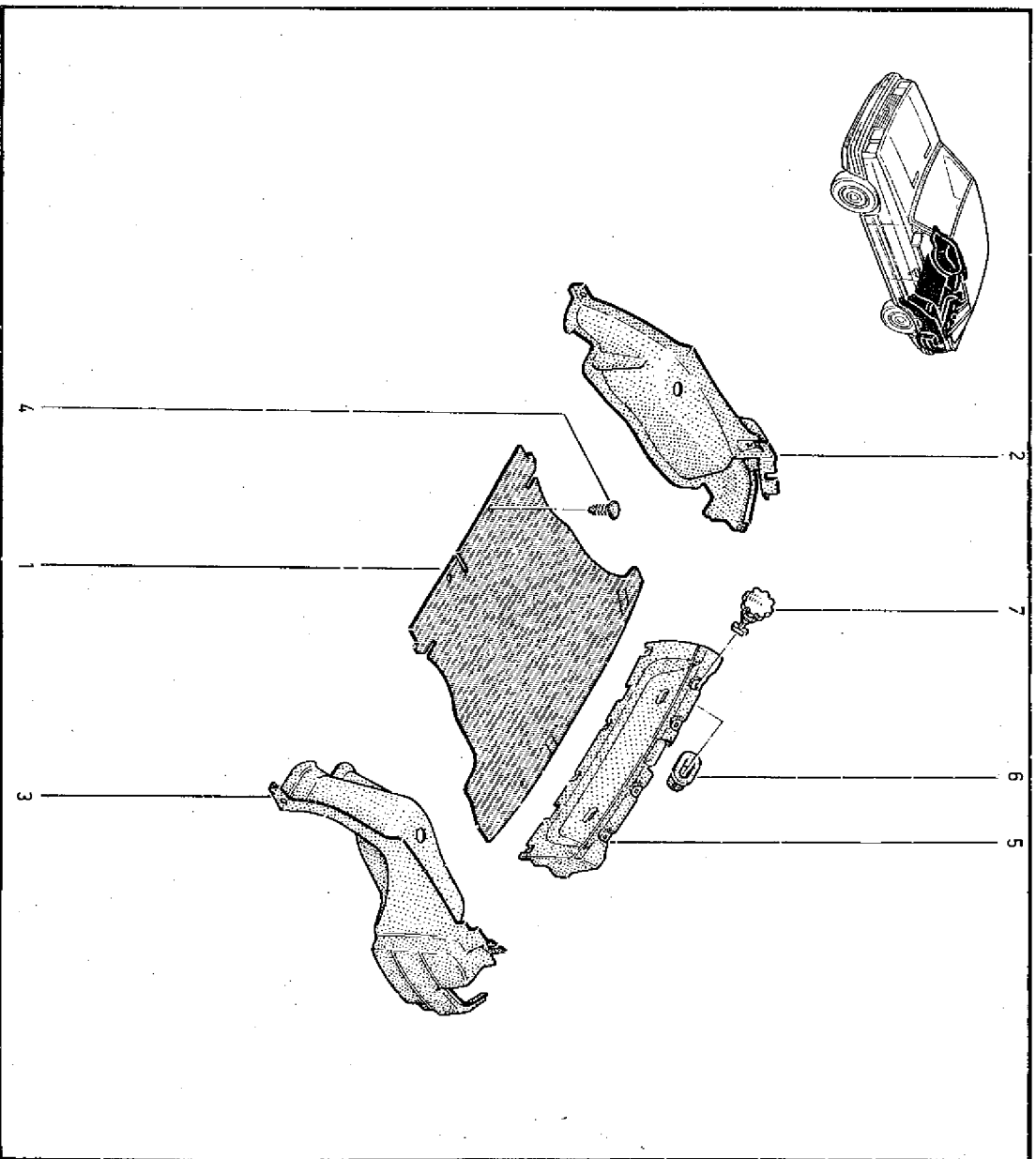

(a) B373 n° 00091 ⇨ n° 32782
B37E n° 00001 ⇨ n° 08614
B375 n° 00001 ⇨ n° 08306

(b) B372 n° 01507 ⇨ n° 86/09
B37G n° 00001 ⇨ n° 08614

(c) B373 n° 32783 → n°
B37I n° 01088 → n°
B375 n° 00610 → n°
(d) B37G n° 08315 → n°

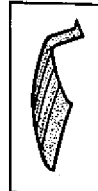

71.10
C.R.1037

- 1 - 77 00 701 090 (a)(d) (a)(B-375)
- 77 00 753 803 (a) (a)(B-375)
- 77 00 711 839 (a)
- 77 02 204 848 (a)(b)(e)
- 77 02 204 647 (a)(b)
- 77 02 204 649 (a)(c)
- 77 02 204 650 (a)(B-375)
- 2 - 77 03 077 107 (a)
- 77 03 077 096 (a)
- 77 02 204 687 (a)(b)
- 3 - 77 00 712 537 (a)
- 77 00 689 839 (a)
- 77 02 204 651 (a)(b)
- 4 - 77 00 713 829 (a)
- 77 00 713 830 (a)
- 77 02 204 646 (a)(b)
- 5 - 77 03 016 365 (a)
- 6 - 77 00 709 467 (a)(d)(e)
- 77 00 709 468 (a)
- 77 02 204 652 (a)(b)
- 77 02 204 653 (a)(b)(e)

(a) B-373	1	n° 30733
(b) B-373	1	n° 32228
(c) B-371	1	n°



71.10
C.R.1037

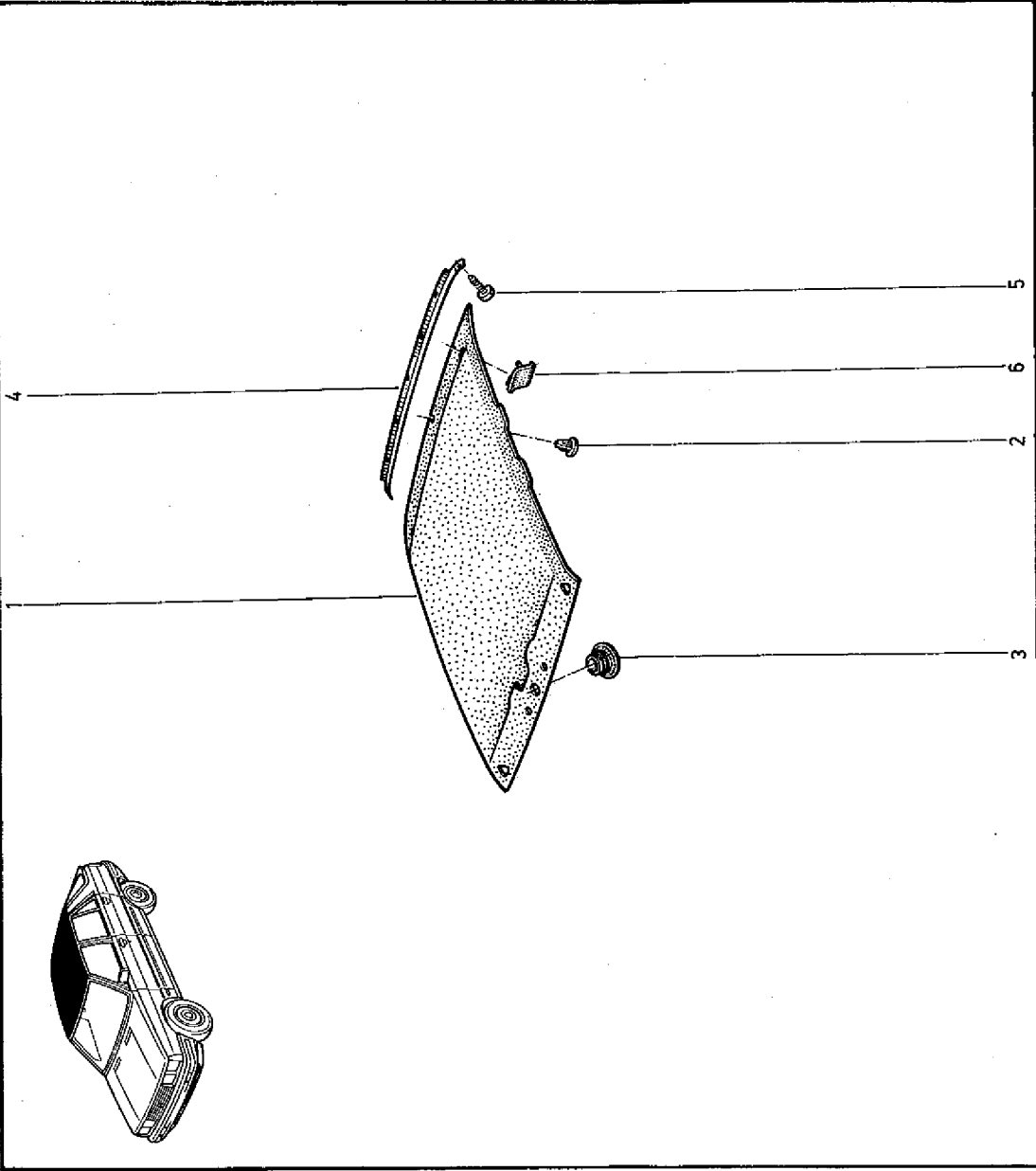

(e) B37G	1	n° 8665
B373	1	n° 33074

(d) B37G	1	n° 8234
B373	1	n° 32229
		n° 8664
		n° 33073



72.01
C.R.1037

B372 - B37G

72.01
C.R.1037



- 1 - 77 02 082 009 (P=1) (a)
- 77 02 092 898 (P=1) (b)
- 77 02 092 829 (P=1) (c)
- 77 02 082 011 (P=1) (a)
- 77 02 092 895 (P=1) (b)
- 77 02 092 831 (P=1) (c)
- 77 02 204 795 (P=1) (d)
- 2 - 77 02 082 029 (P=1) (a)
- 77 02 082 031 (P=1) (a)
- 77 02 092 833 (P=1) (b)
- 77 02 092 835 (P=1) (c)
- 77 02 204 096 (P=1) (d)
- 3 - 77 02 082 030 (P=1) (a)
- 77 02 082 032 (P=1) (a)
- 77 02 092 834 (P=1) (b)
- 77 02 092 836 (P=1) (c)
- 77 02 204 097 (P=1) (d)
- 4 - 77 02 082 010 (P=1) (a)
- 77 02 092 894 (P=1) (b)
- 77 02 092 830 (P=1) (c)
- 77 02 082 012 (P=1) (a)
- 77 02 092 896 (P=1) (b)
- 77 02 092 832 (P=1) (c)
- 77 02 204 796 (P=1) (d)
- 5 - 77 03 077 111
- 6 - 8558231
- 7 - 8558230

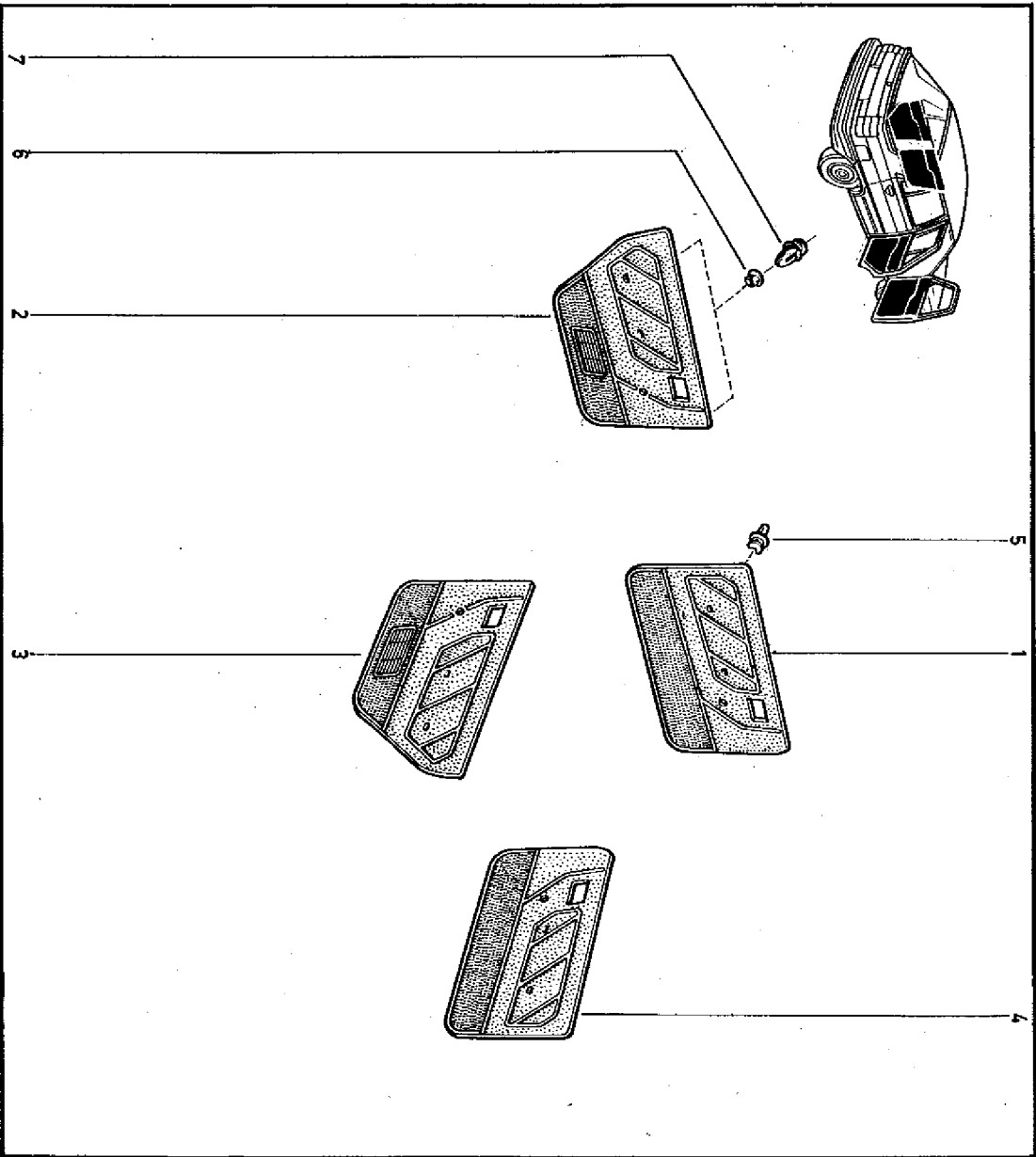

- (a) / B372 ~~1~~ n° 1 → n°
- (b) / B372 ~~1~~ n° 1 → n°
- (c) / B376 ~~1~~ n° 5564 → n° 6315



72.01.1
C.R.1037

- 1 - 77 02 208 345 (2)
- 77 02 208 343 (2)
- 2 - 77 02 208 349 (2)
- 77 02 208 347 (2)
- 3 - 77 02 208 348 (2)
- 77 02 208 346 (2)
- 4 - 77 02 208 344 (2)
- 77 02 208 342 (2)
- 5 - 77 03 081 015
- 6 - 8558231
- 7 - 8558230

(a)

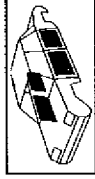

72.01.1
C.R.1037

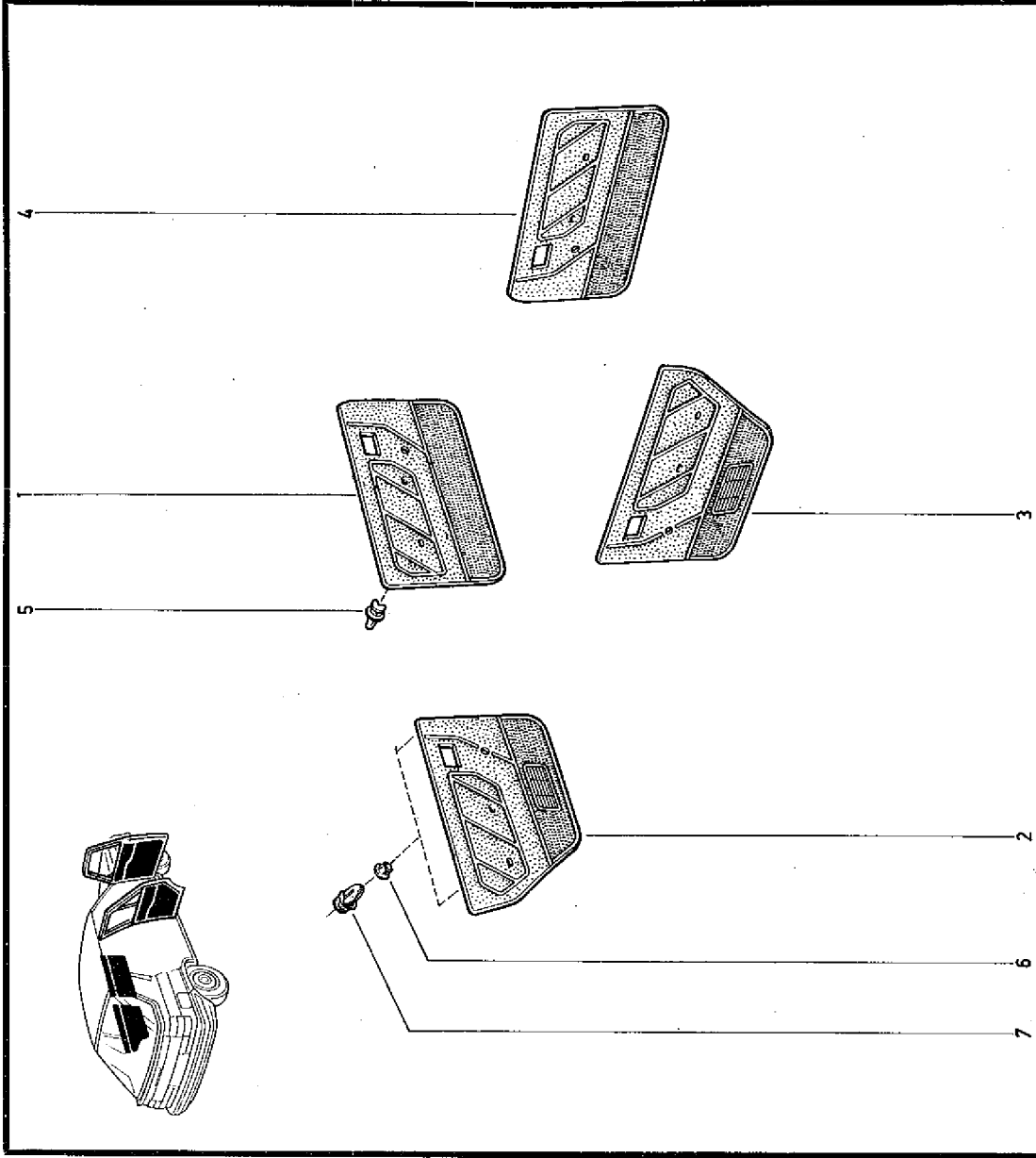



72.03
C.R.1037

- 1 - 77 02 082 015 [2-0]
- 77 02 082 017 [2-0]
- 2 - 77 03 077 111
- 3 - 77 00 704 844 [2-0]
- 77 00 695 372 [5-1]
- 4 - 77 02 082 035 [2-0] (a)
- 77 02 082 037 [2-0] (a)
- 77 02 092 889 [2-0] (b)
- 77 02 092 891 [2-0] (b) (c)
- 77 02 1204 100 [2-0] (d)
- 77 02 090 963 [5-1] (B-375)
- 5 - 77 00 704 840 [2-0]
- 77 00 695 378 [5-1]
- 6 - 77 03 076 115
- 7 - 77 00 704 841 [2-0]
- 77 00 695 379 [5-1]
- 8 - 77 02 082 036 [2-0] (a)
- 77 02 082 038 [2-0] (a)
- 77 02 092 890 [2-0] (b)
- 77 02 092 892 [2-0] (b) (c)
- 77 02 1204 101 [2-0] (d)
- 77 02 090 964 [5-1] (B-375)
- 9 - 77 02 082 016 [2-0]
- 77 02 082 018 [2-0]
- 10 - 77 00 704 845 [2-0]
- 77 00 695 373 [5-1]
- 11 - 77 02 090 667 [2-0] (a)
- 77 02 090 665 [2-0] (a)
- 77 02 092 885 [2-0] (b)
- 77 02 092 887 [2-0] (b) (c)
- 77 02 204 092 [2-0] (d)
- 77 02 090 993 [5-1] (B-375)
- 12 - 77 02 090 668 [2-0] (a)
- 77 02 090 666 [2-0] (a)
- 77 02 092 886 [2-0] (b)
- 77 02 092 888 [2-0] (b) (c)
- 77 02 204 093 [2-0] (d)
- 77 02 090 994 [5-1] (B-375)
- 13 - 8558231
- 14 - 8558230

- (a) /B373 → n° 1 → n° 16883
- (b) /B373 → n° 16884 → n° 30055
- (c) /B37E → n° 1 → n° 3440
- (d) /B373 → n° 30056 → n° 30733
- /B37E → n° 3441 → n°

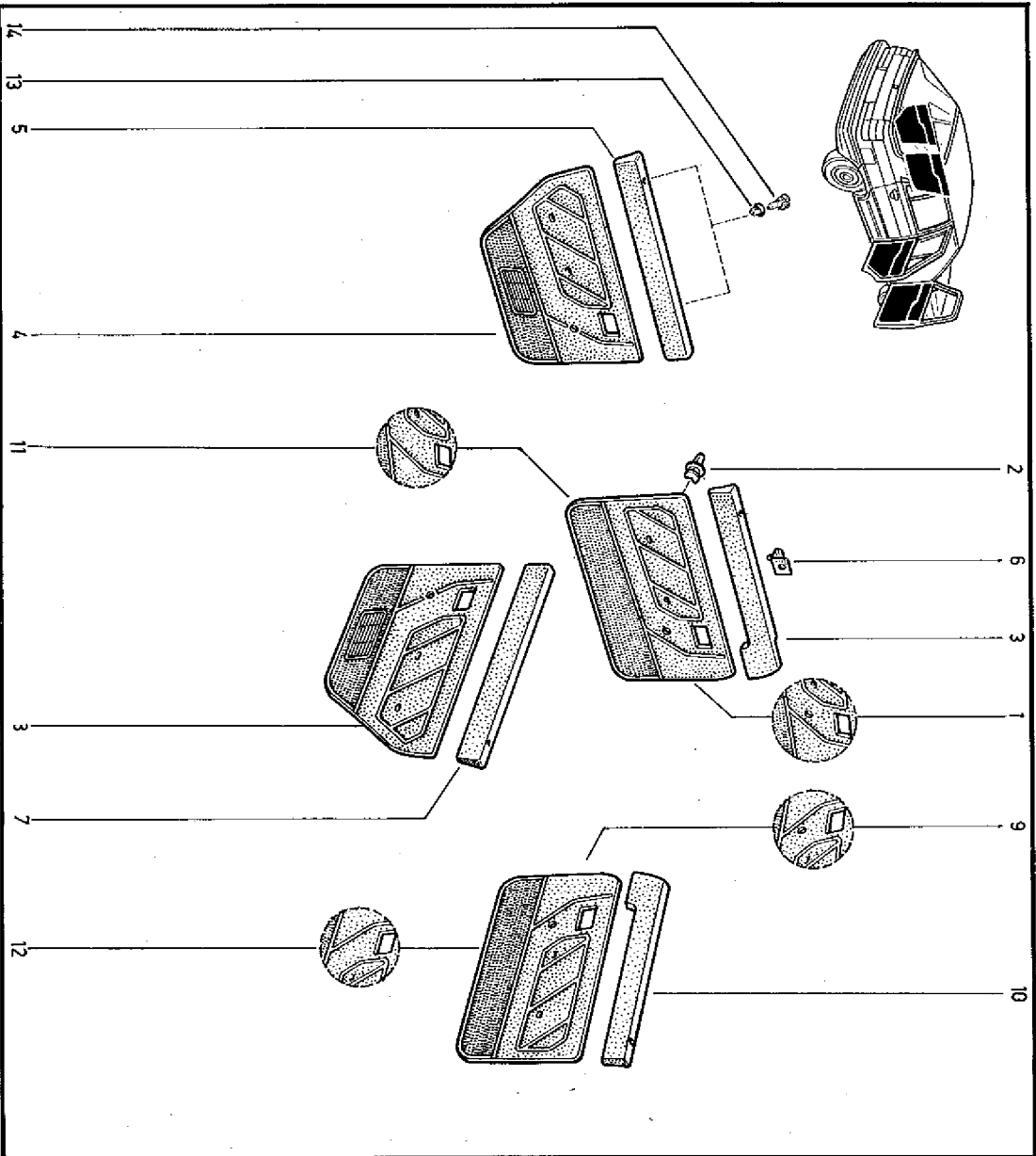

B373 B37E B375

72.03
C.R.1037

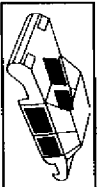



72.03.1
C.R.1037



72.03.1
C.R.1037

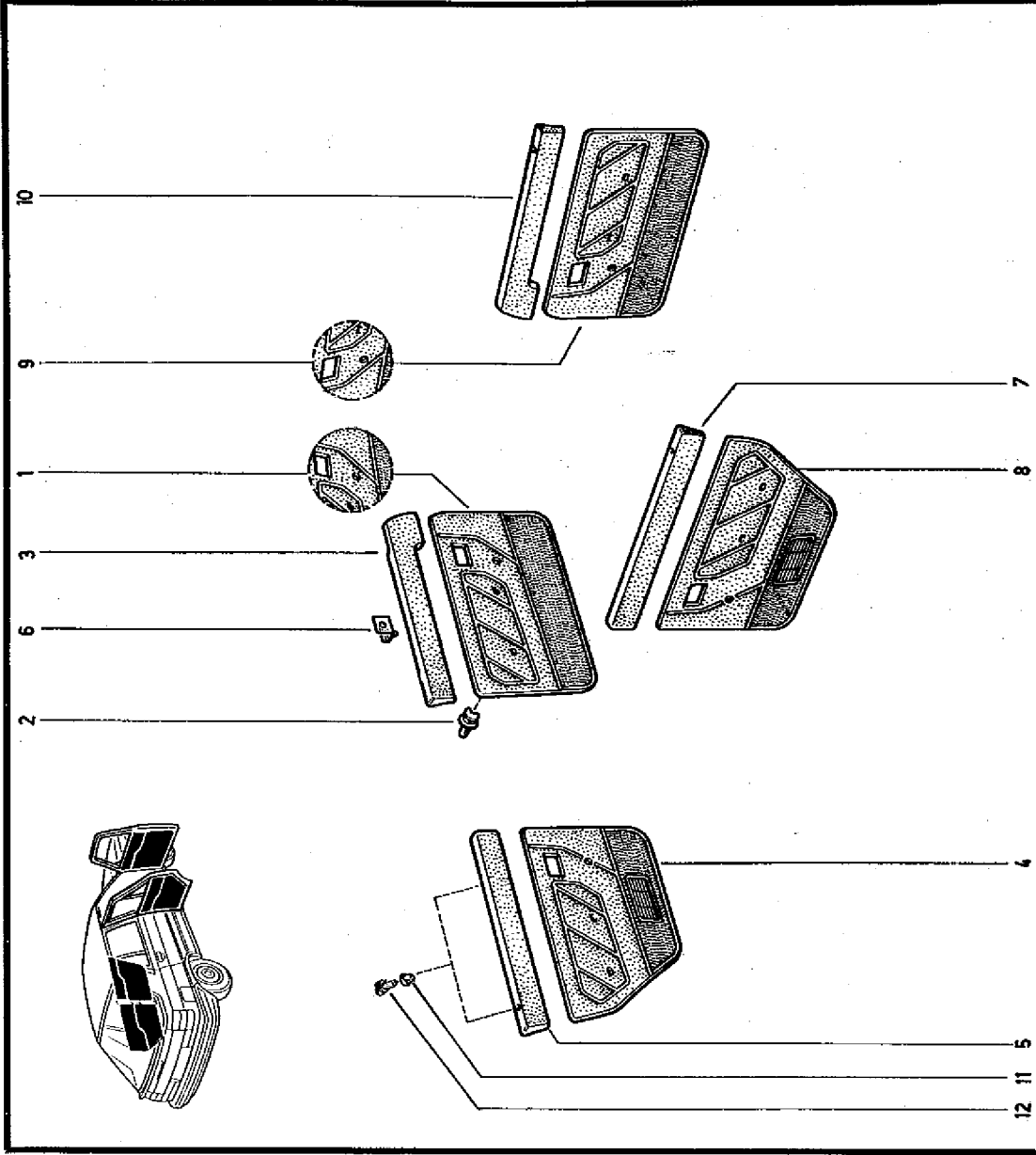

- 1- 77 02 208 421 [20] (b)
- 77 02 204 677 [20] (c)
- 77 02 210 656 [20] (d)
- 77 02 204 679 [5] (a)
- 77 02 204 681 [20] [5] (a)
- 77 02 208 423 [20] (b)
- 2- 77 03 077 111
- 3- 77 00 695 372 [5]
- 4- 77 02 204 831 [20] [5] (a)
- 77 02 204 829 [5] (a)
- 77 02 208 427 [20] (b)
- 77 02 204 827 [20] (c)
- 77 02 210 658 [20] (d)
- 77 02 208 425 [20] (b)
- 5- 77 00 695 378 [5]
- 6- 77 03 076 115
- 7- 77 00 695 379 [5]
- 8- 77 02 204 832 [20] [5] (a)
- 77 02 204 830 [5] (a)
- 77 02 204 828 [20] (c)
- 77 02 210 659 [20] (d)
- 77 02 208 426 [20] (b)
- 77 02 208 428 [20] (b)
- 9- 77 02 204 678 [20] (c)
- 77 02 210 657 [20] (d)
- 77 02 204 680 [5] (a)
- 77 02 204 682 [20] [5] (a)
- 77 02 208 422 [20] (b)
- 77 02 208 424 [20] (b)
- 10- 77 00 695 373 [5]
- 11- 8558231
- 12- 8558230

(a) B-375	n°	732	→	n°
(b) B-378	n°	30734	→	n°
(c) B-371	n°	1	→	n° 953
(d) B-371	n°	954	→	n°

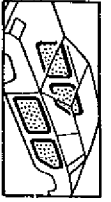

72.15
C.R.1037

- 1 - 77 03 016 034
- 2 - 77 03 081 009
- 3 - 77 00 676 571 (S)(b)
- 77 00 686 033 (S)(c)
- 77 02 204 657 (S)(d)
- 4 - 77 00 648 882 (S)(b)
- 77 00 683 711 (S)(b)
- 5 - 77 03 072 209
- 6 - 77 00 631 558
- 7 - 77 03 081 015
- 8 - 77 02 082 109 (S)(b)
- 77 02 082 107 (S)(c)
- 77 02 204 659 (S)(d)
- 9 - 77 02 082 110 (S)(b)
- 77 02 082 108 (S)(c)
- 77 02 204 660 (S)(d)
- 10 - 77 00 676 570 (S)(b)
- 77 00 686 082 (S)(c)
- 77 02 204 658 (S)(d)
- 11 - 77 04 001 201 (S)(b)
- 77 04 001 203 (S)(c)
- 77 02 082 215 (S)
- 12 - 77 04 001 197 (S)(a)
- 77 04 001 199 (S)(c)
- 77 02 082 217 (S)(c)
- 13 - 77 03 016 046
- 77 03 016 390
- 14 - 77 03 046 052
- 15 - 77 03 074 190
- 16 - 77 04 001 198 (S)(c)
- 77 04 001 200 (S)(c)
- 77 02 082 214 (S)(c)
- 77 02 082 216 (S)(c)
- 17 - 77 00 759 744
- 18 - 77 03 016 034
- 19 - 77 03 016 278
- 20 - 77 04 003 389 (b)
- 21 - 77 02 204 536
- 22 - 77 02 204 537
- 23 - 77 04 003 390
- 24 - 77 04 001 202 (S)(b)

- (a) / B-372
- (b) / B-373
- (c) / B-376
- (c) / B-371
- (c) / B-375

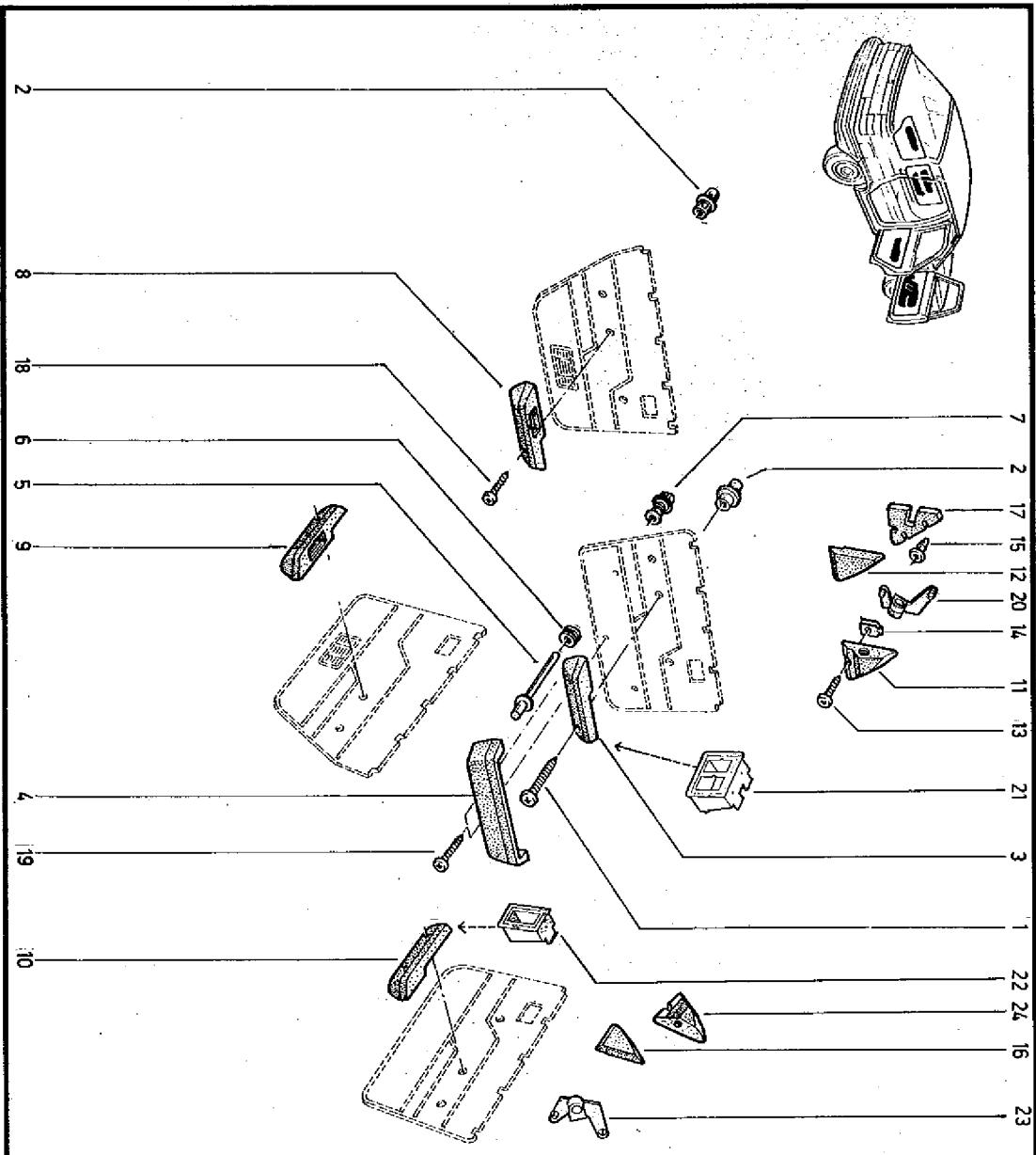

72.15
C.R.1037

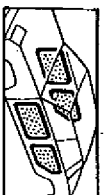



74.01
C.R.1037

- 1 - 77 00 757 226 (S) (a)
77 00 757 220 (P)
- 77 00 757 228 (E)
- 77 02 204 698 (E)
- 2 - 77 00 707 886 (P)
- 77 00 750 657 (E)
- 77 00 714 394 (P) (b)
- 77 02 092 788 (S) (a)
- 77 02 204 708 (E)
- 3 - 77 03 074 226 (P)
- 77 03 074 224 (E)
- 4 - 77 03 016 336
- 5 - 77 00 707 885 (P)
- 77 00 750 656 (E)
- 77 00 714 393 (P) (b)
- 77 02 092 789 (S) (a)
- 77 02 204 709 (E)
- 6 - 77 01 202 036
- 7 - 77 01 202 051 (A)
- 77 01 202 052 (B)
- 8 - 77 03 088 063
- 77 03 088 048
- 9 - 77 03 077 078
- 10 - 77 00 707 878 (P)
- 77 00 750 664 (S)
- 77 02 204 712 (E)
- 11 - 77 00 707 877 (P)
- 77 00 750 663 (S)
- 77 02 204 713 (E)
- 12 - 77 00 707 884 (a)
- 13 - 77 00 707 883 (a)

(a)/B-375

(b)/B-375 - B-37T



74.01
C.R.1081

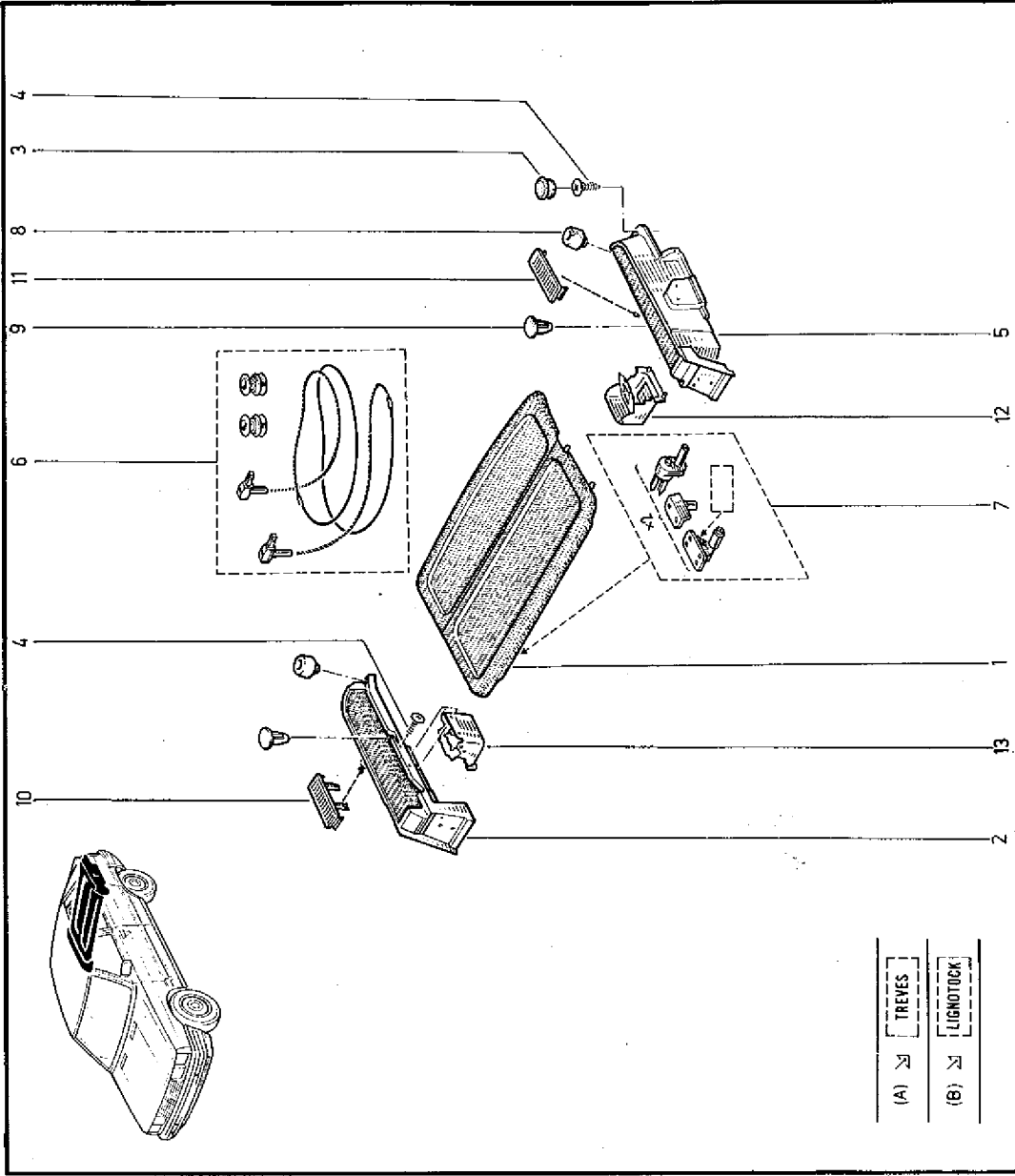

(A)	TREVES
(B)	LIGNOTOCCO

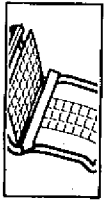

75.01
C.R.1037

- 1 - 77 00 697 609
- 2 - 77 00 711 550 (b)
- 3 - 77 00 708 196
- 4 - 77 00 711 486
- 5 - 77 03 001 158
- 6 - 79 03 056 014
- 7 - 77 00 696 509
- 8 - 77 00 694 013
- 9 - 77 00 703 716 (b)
- 10 - 77 00 715 263 (b)
- 11 - 77 00 760 361 (a)

(a) B372
(b) B373

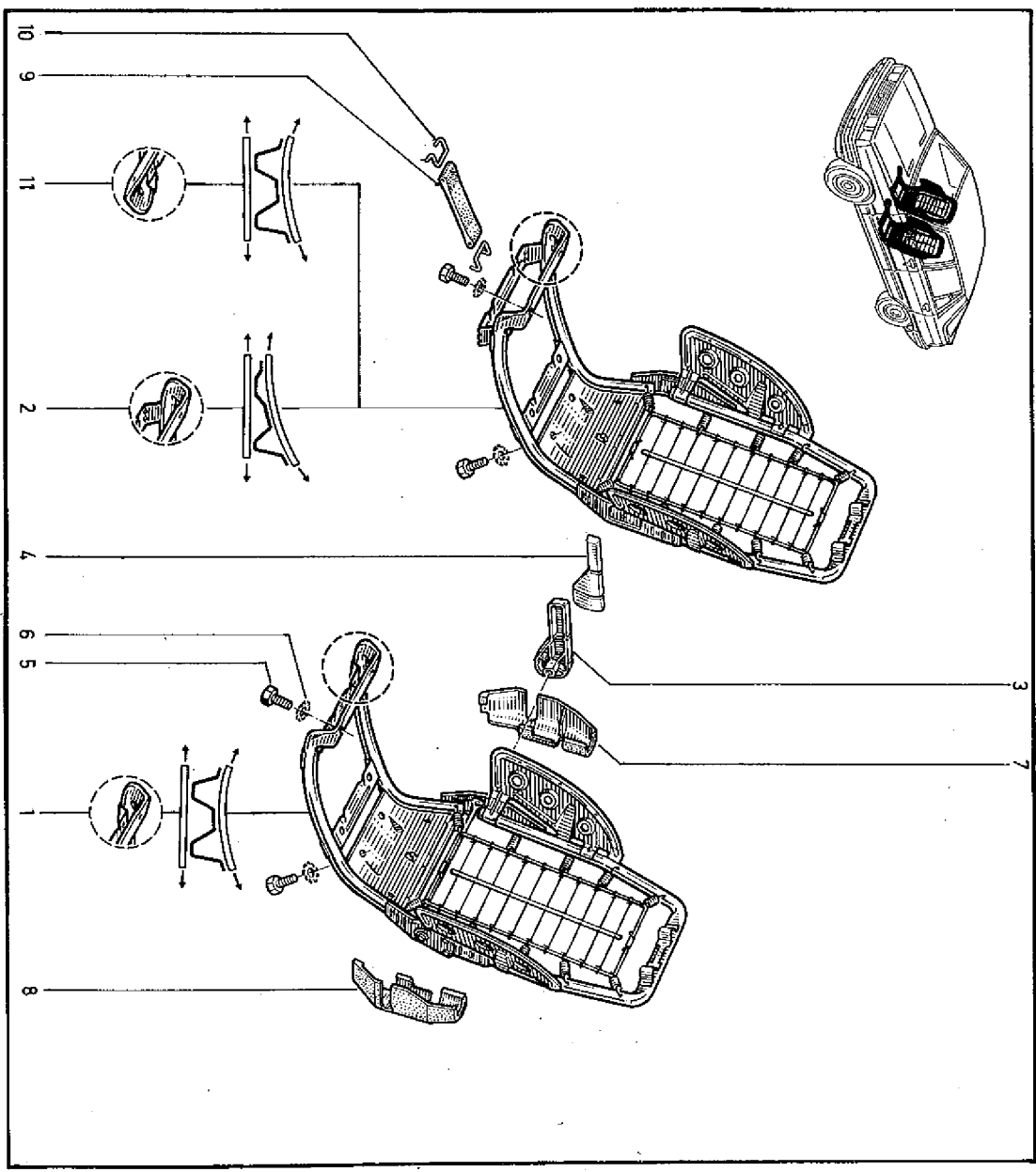

75.01
C.R.1037

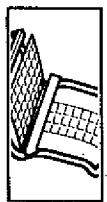



75.10
C.R.1037

B372

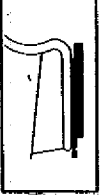

75.10
C.R.1037

- 1 - 77 01 349 351
- 2 - 77 00 697 293
- 3 - 77 03 025 004
- 4 - 77 00 573 714
- 5 - 77 03 001 992
- 6 - 77 03 058 079
- 7 - 77 03 033 016
- 8 - 77 00 696 480
- 9 - 77 03 025 012
- 10 - 77 01 028 457
- 11 - 77 01 028 458 †
- 77 00 763 302

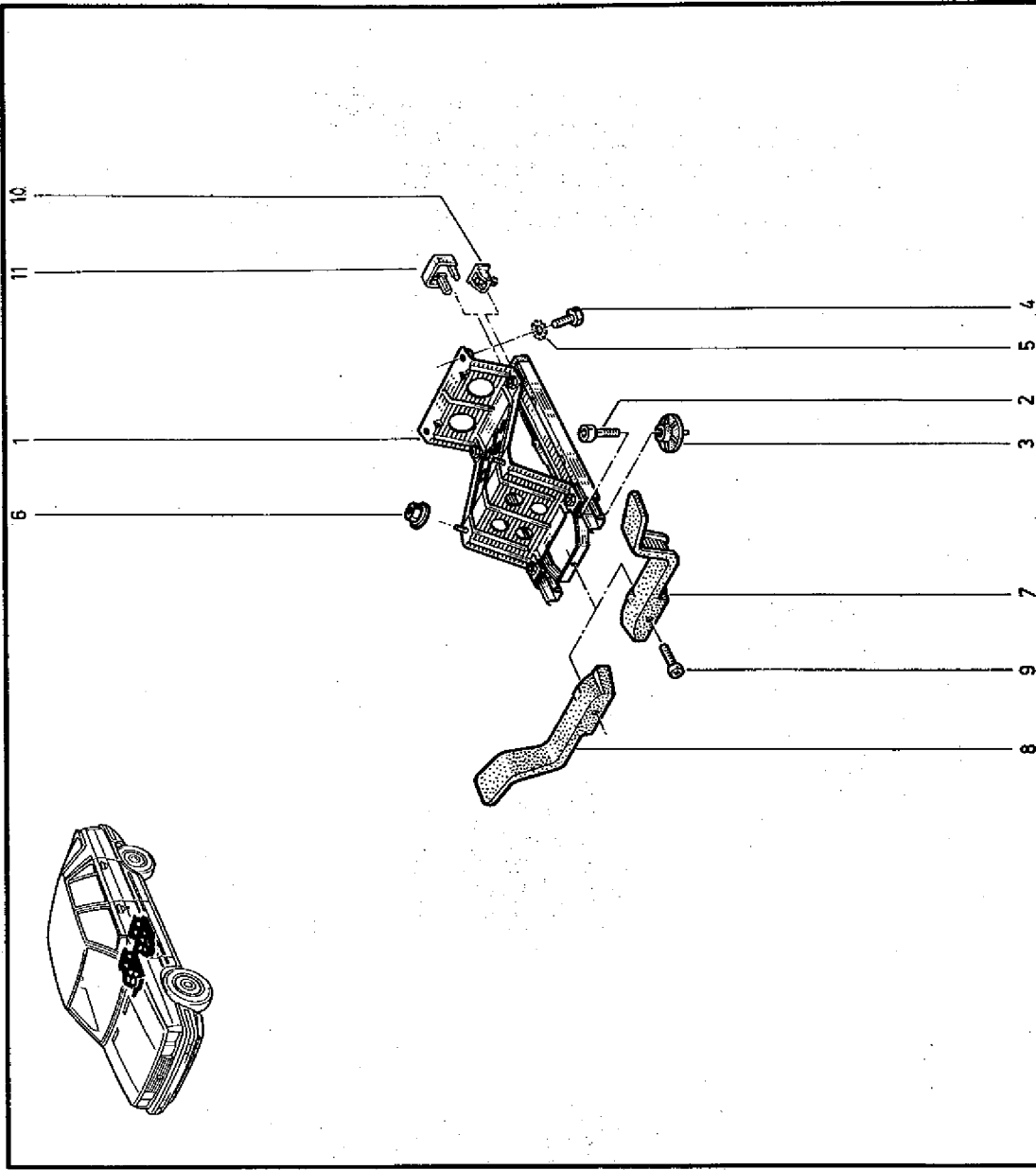

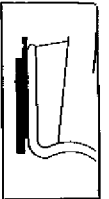

75.15
C.R.1037

- 1 - 77 01 349 352 (a)
77 01 349 353 (b)
- 2 - 77 00 694 788 (a)
- 3 - 77 00 693 965
- 4 - 77 01 349 353
- 5 - 77 00 693 981
- 6 - 77 00 693 527
- 7 - 77 00 696 516
- 8 - 77 00 696 480
- 9 - 77 03 025 012
- 10 - 77 03 083 016
- 11 - 77 03 025 004
- 12 - 77 00 573 714
- 13 - 77 03 001 992
- 14 - 77 03 077 060
- 15 - 77 01 028 457
- 16 - 77 01 028 458 +
77 00 763 302
- 17 - 77 00 694 789 (b)

B373

75.15
C.R.1037

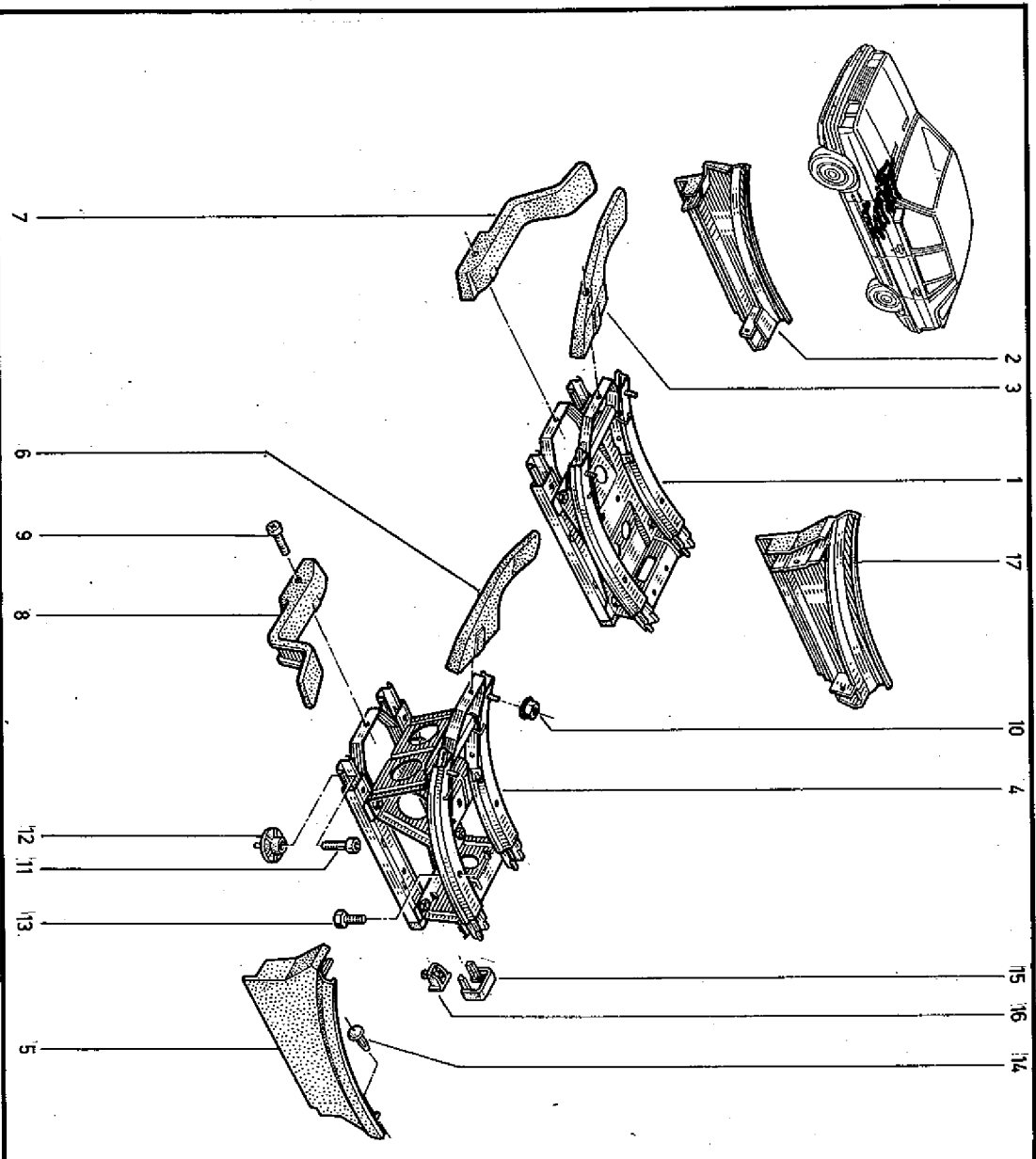
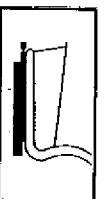

(a)	B373	→	n°	022502
(b)	B373	→	n°	022503



76.01
C.R.1037



76.01
C.R.1037

B372

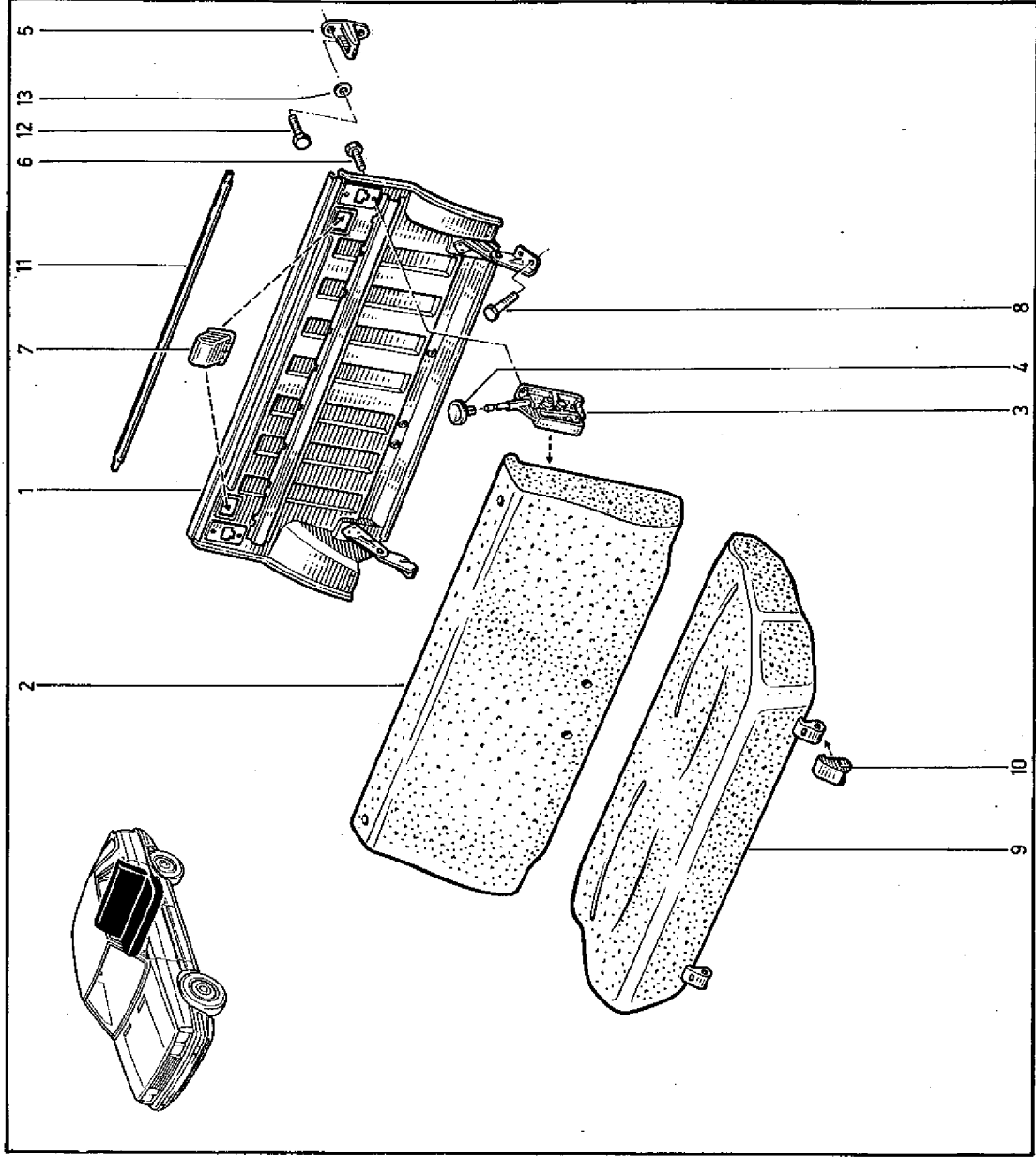

- 1 - 77 00 716 409
- 2 - 77 00 711 027
- 3 - 77 00 711 046
- 4 - 77 00 711 045
- 5 - 77 00 713 975
- 6 - 77 03 101 034
- 7 - 77 00 717 104
- 8 - 77 03 019 099
- 9 - 77 00 758 641
- 10 - 77 00 761 525
- 11 - 77 00 761 526
- 12 - 77 00 711 044
- 13 - 77 03 019 087
- 13 - 77 03 019 099
- 13 - 77 03 053 127



76.02
C.R.1037

- 1 - 77 00 758 311
- 2 - 77 00 711 046
- 3 - 77 00 711 045
- 4 - 77 00 713 975
- 5 - 77 03 101 034
- 6 - 77 00 710 695
- 7 - 77 00 758 309
- 8 - 77 00 710 894
- 9 - 77 03 016 291
- 10 - 77 00 758 313
- 11 - 77 03 019 099 (a)
- 12 - 77 00 758 642
- 13 - 77 00 758 640
- 14 - 77 00 761 525 281
- 15 - 77 00 761 526 281
- 16 - 77 03 077 066 +
- 17 - 77 02 074 025
- 18 - 77 00 711 342
- 19 - 77 00 523 646
- 20 - 77 03 081 019
- 21 - 77 03 019 086 +
- 22 - 77 02 026 192
- 23 - 77 03 053 127 (b)
- 24 - 50 03 019 002 (b)
- 24 - 79 03 053 033 (b)

B373

76.02
C.R.1037

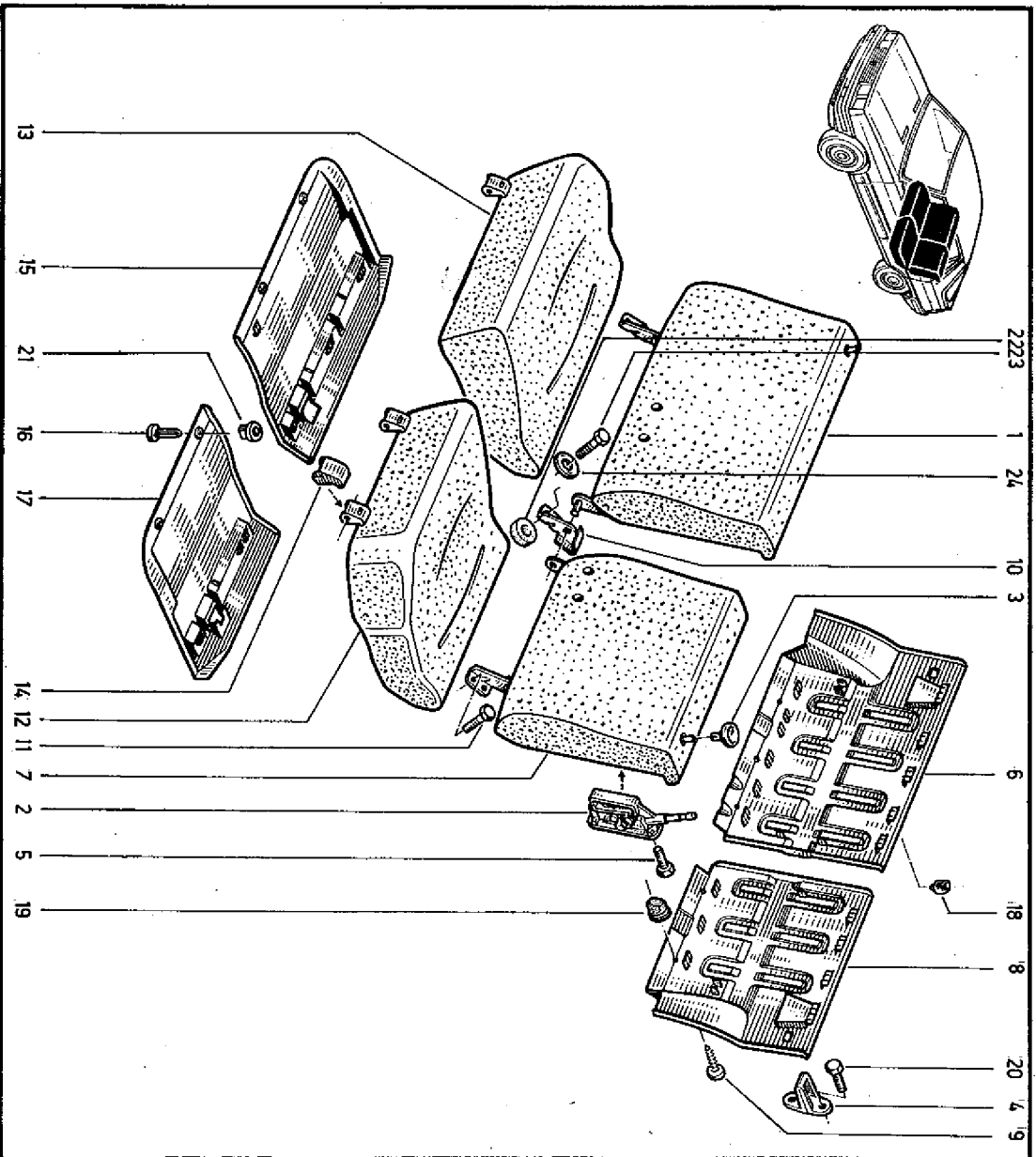

	B37E	1	→	n° 002735
(a)	B373	1	→	n° 026859
	B375	1	→	n° 000644
	B37E	1	→	n° 002736
(b)	B373	1	→	n° 026860
	B375	1	→	n° 000645



77.01
C.R.1037

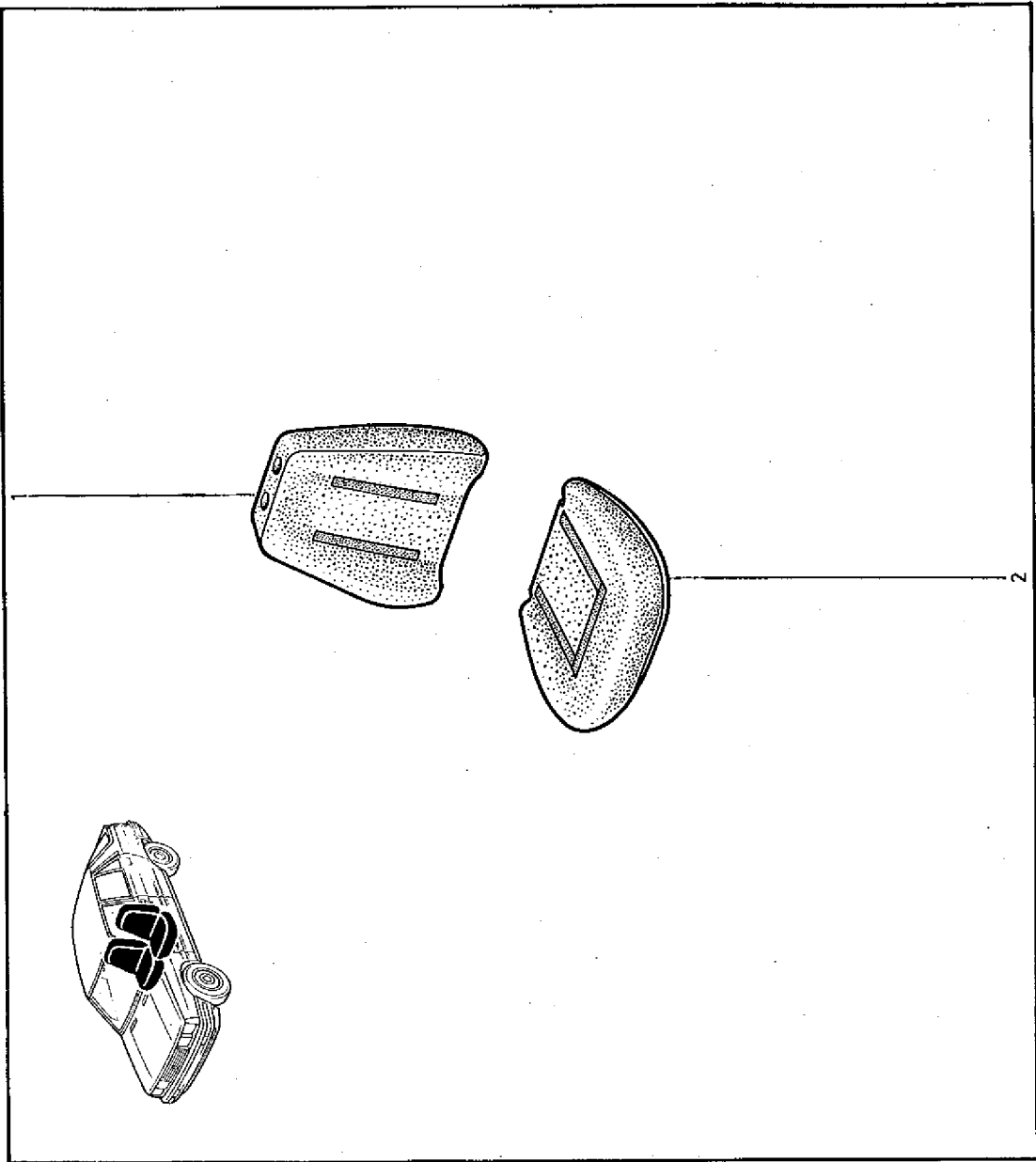

77.01
C.R.1037



- 1 - 77 00 693 020
- 2 - 77 00 718 096

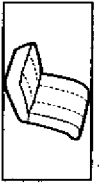

77.05
C.R.1037

- 1 - 77 00 718 096
- 2 - 77 00 712 672
- 3 - 77 00 713 690
- 4 - 77 00 713 689
- 5 - 77 00 718 362

B375

77.05
C.R.1037

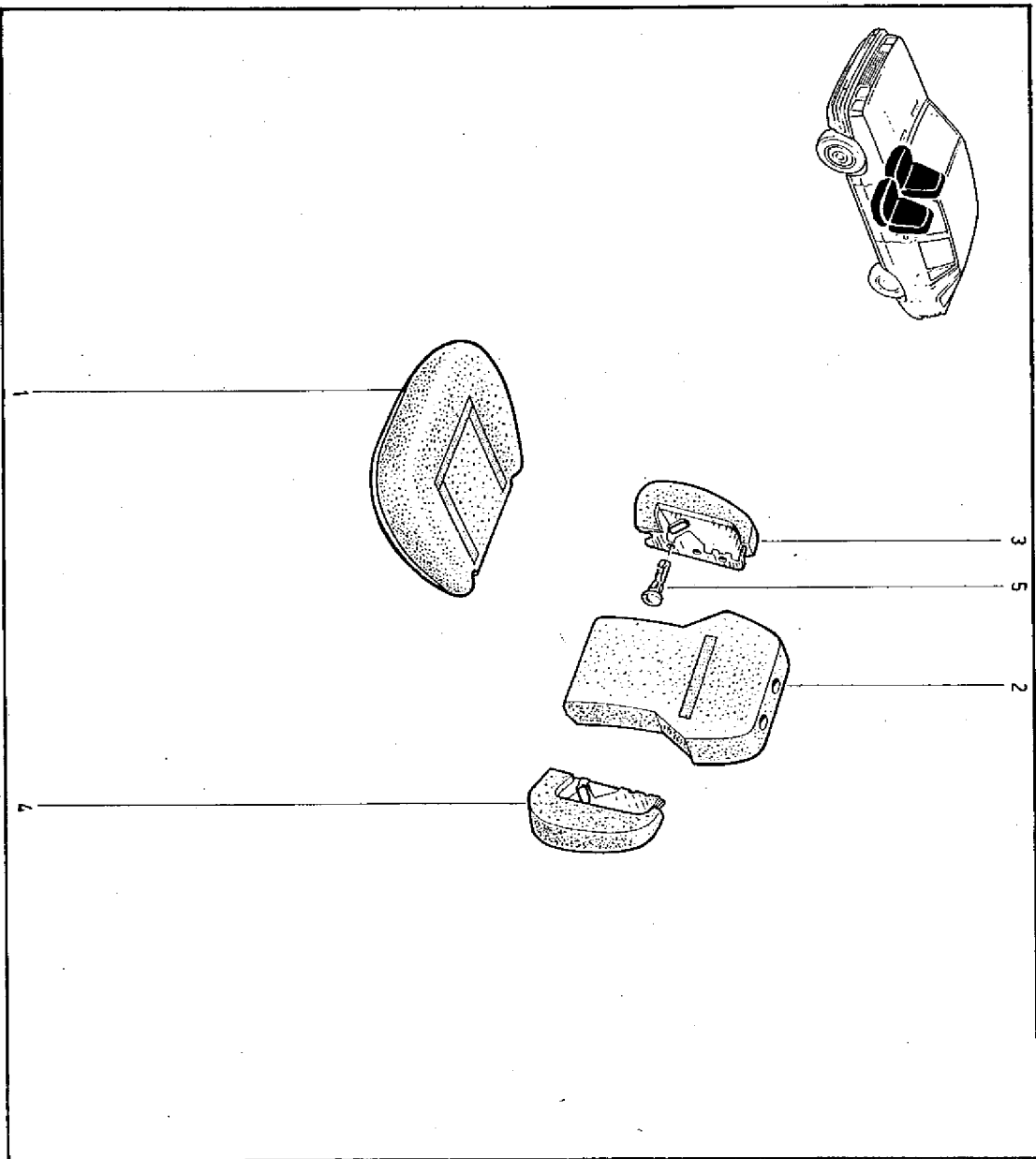
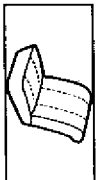



77.06
C.R.1037

- 1 - 77 02 090 874 (a)
- 77 02 095 759 (b)
- 2 - 77 02 090 876 (a)
- 77 02 095 761 (b)
- 3 - 77 02 090 875 (a)
- 77 02 095 760 (b)
- 4 - 77 02 090 870 (a)
- 77 02 095 758 (b)

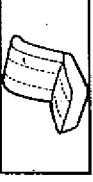

77.06
C.R.1037

B375 B37E

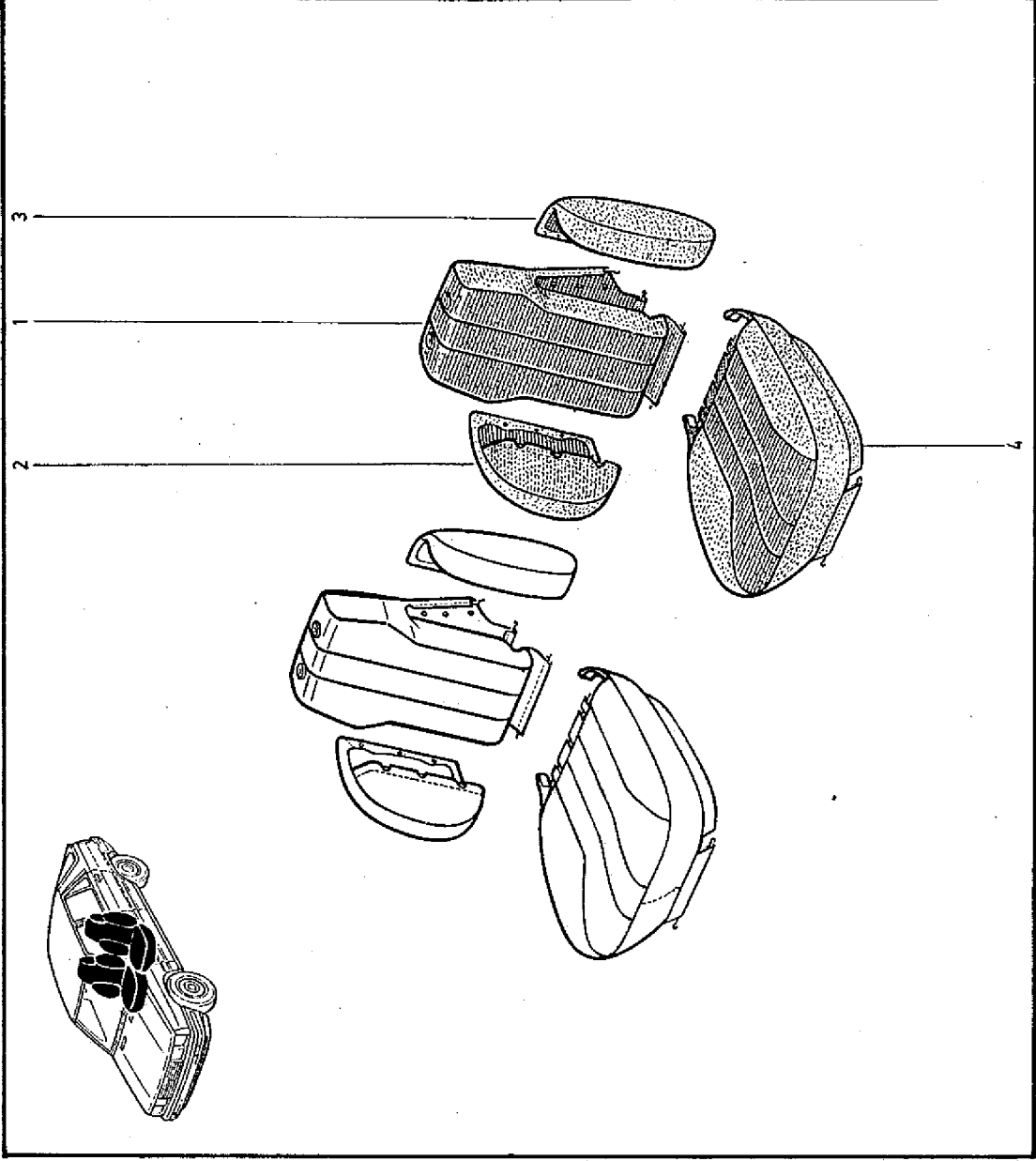

(a) B375
(b) B37E



77.061
C.R.1037

- 1- 77 02 204 740 (a)
- 77 02 204 741 (c)
- 77 02 209 296 (d)
- 77 02 204 293 (b)
- 2- 77 02 204 742 (a)
- 77 02 204 744 (c)
- 77 02 209 297 (d)
- 77 02 095 761 (b)
- 3- 77 02 204 743 (a)
- 77 02 204 745 (c)
- 77 02 209 298 (d)
- 77 02 095 760 (b)
- 4- 77 02 204 736 (a)
- 77 02 204 737 (c)
- 77 02 209 295 (d)
- 77 02 204 232 (b)

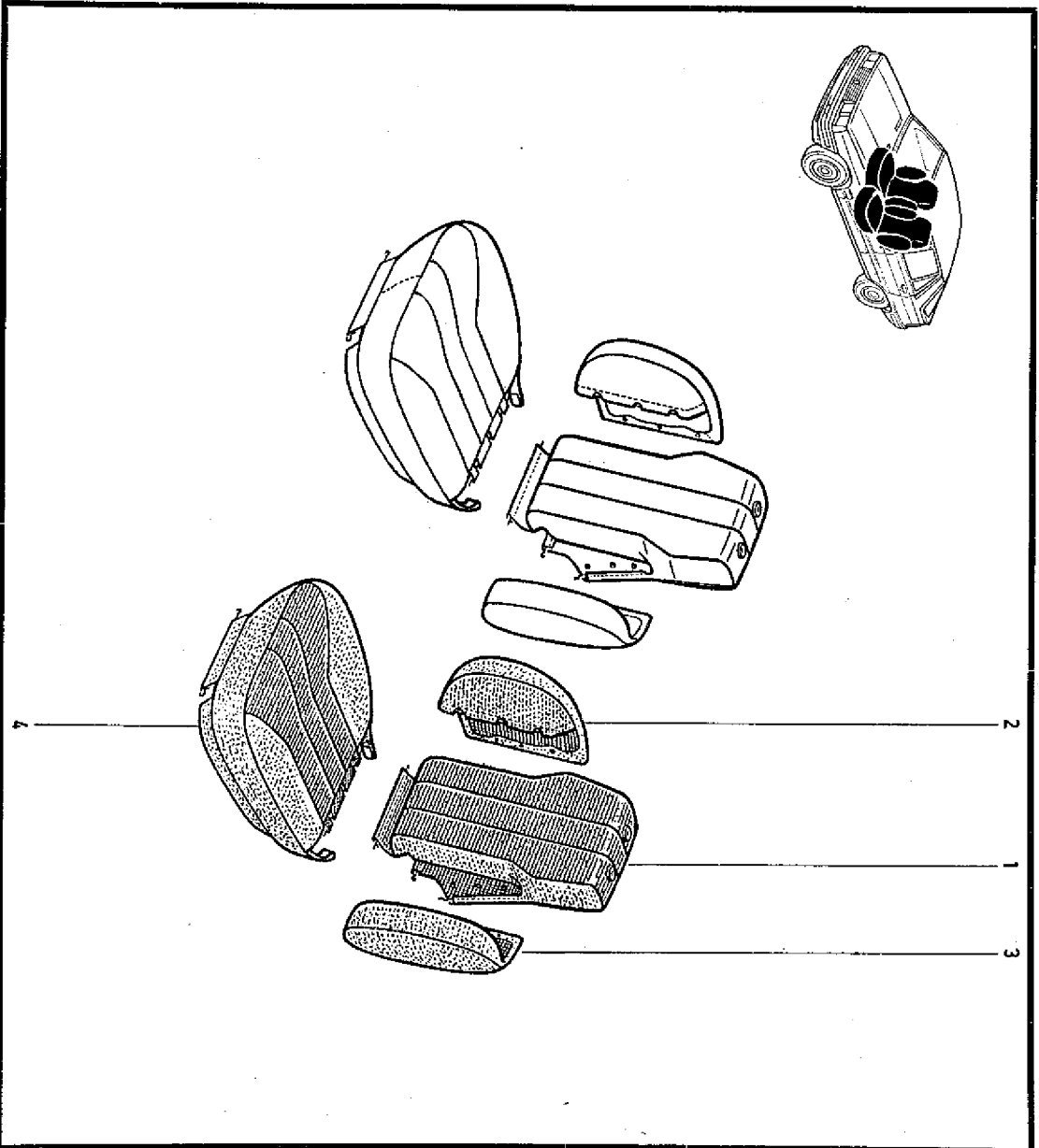

77.061
C.R.1037



(a) B37T	→	n°	→	n°	
(b) B375	→	n°	732	→	n°
(c) B37T	→	n°	→	n°	953
(d) B37T	→	n°	954	→	n°



77.10
C.R.1037

- 1 - 77 02 082 232 231 (a) #
- 77 02 082 156 231 (b) #
- 77 02 082 157 231 (b) #
- 77 02 082 233 231 (a) #
- 77 02 082 158 231 (b) #
- 77 02 082 159 231 (b) (d)
- 77 02 092 814 231 (d)
- 77 02 092 813 231 (c)
- 77 02 092 812 231 (c)
- 2 - 77 02 082 230 231 (a) #
- 77 02 082 152 231 (b) #
- 77 02 082 153 231 (b) #
- 77 02 082 231 231 (a) #
- 77 02 082 154 231 (b) #
- 77 02 082 155 231 (b) (d)
- 77 02 092 811 231 (d)
- 77 02 092 810 231 (c)
- 77 02 092 809 231 (c)
- 3 - 77 00 651 422 (a)
- 4 - 77 00 651 421
- 5 - 77 00 651 423

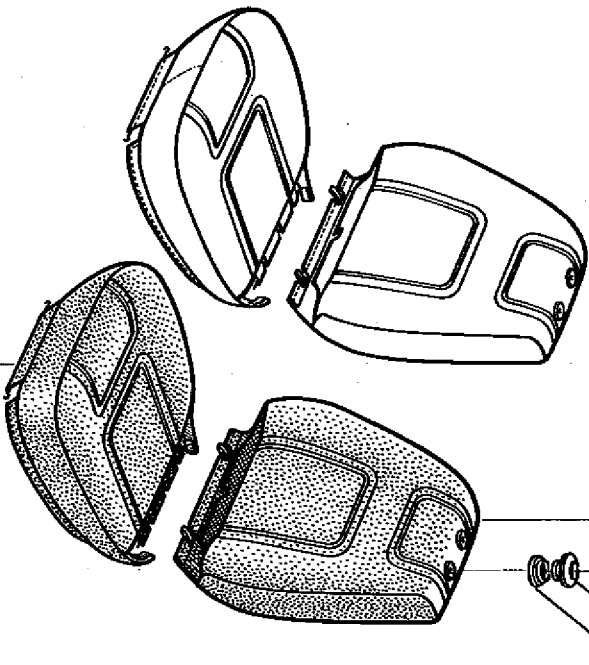
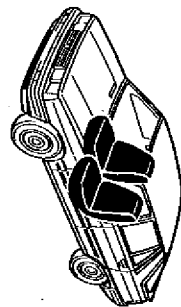

77.10
C.R.1037



- (a) B372 MOD86
- (b) B373 n°16883
- (c) B373 n°16884
- (d) B37G n°



77.10.1
C.R.1037

- 1 - 77 02 204 738 (a) (a)
- 77 02 204 739 (a) (a)
- 77 02 208 436 (b) (b)
- 77 02 208 437 (a) (b)
- 2 - 77 02 204 734 (a) (a)
- 77 02 204 735 (a) (a)
- 77 02 208 434 (b) (b)
- 77 02 208 435 (a) (b)
- 3 - 77 00 651 422
- 4 - 77 00 651 421



77.10.1
C.R.1037

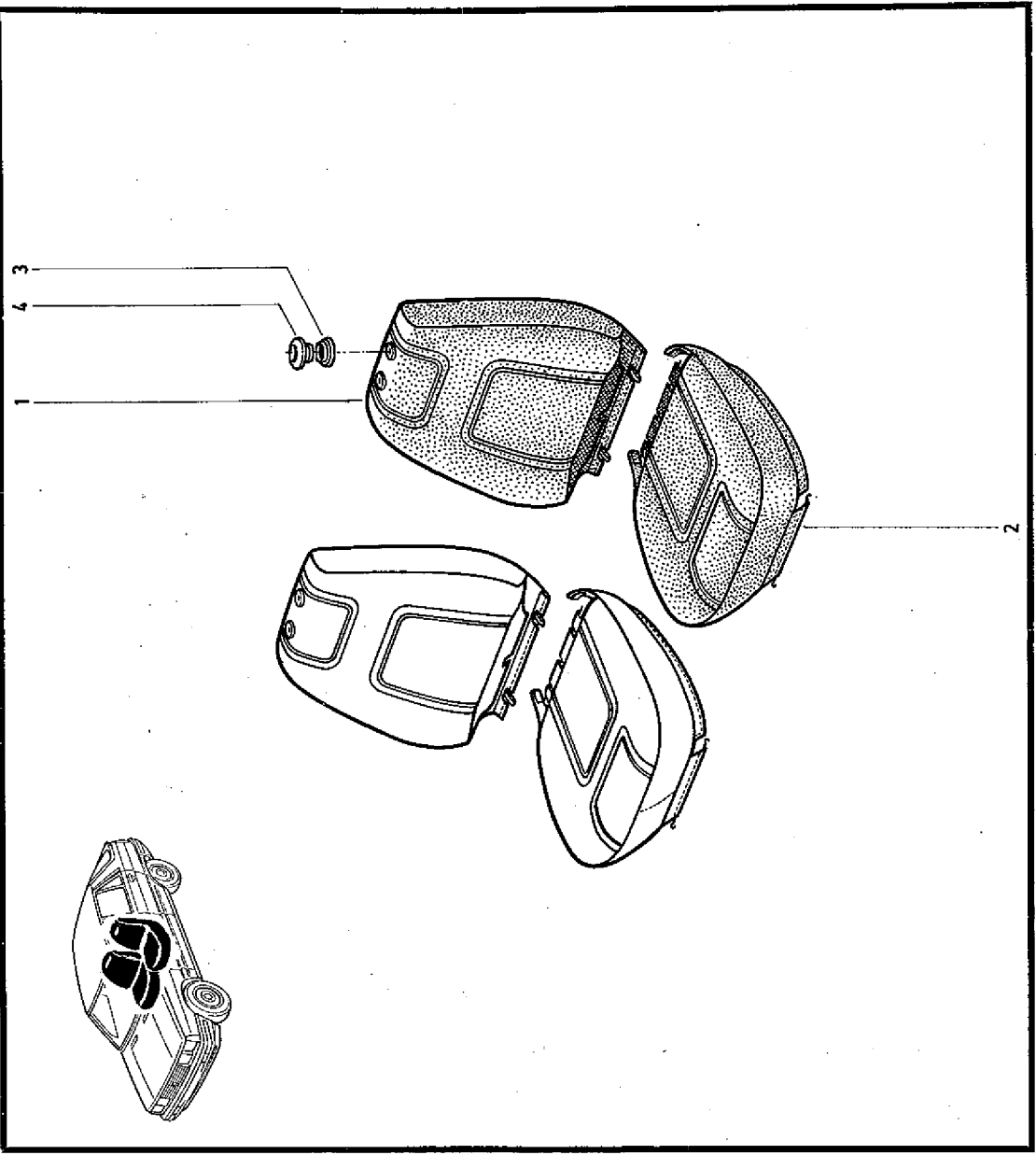

(a) B 37 G n° 6621 ↑ n°

(b) B 37 S n° 30734 ↑ n°

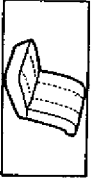

77.10.2
C.R.1037

- 1 - 77 02 210 972 (2) (1)
- 77 02 210 971 (2) (2)
- 2 - 77 02 210 970 (2) (1)
- 77 02 210 969 (2) (2)
- 3 - 77 00 651 422
- 4 - 77 00 651 421

B97G n° 9232 → n°.....

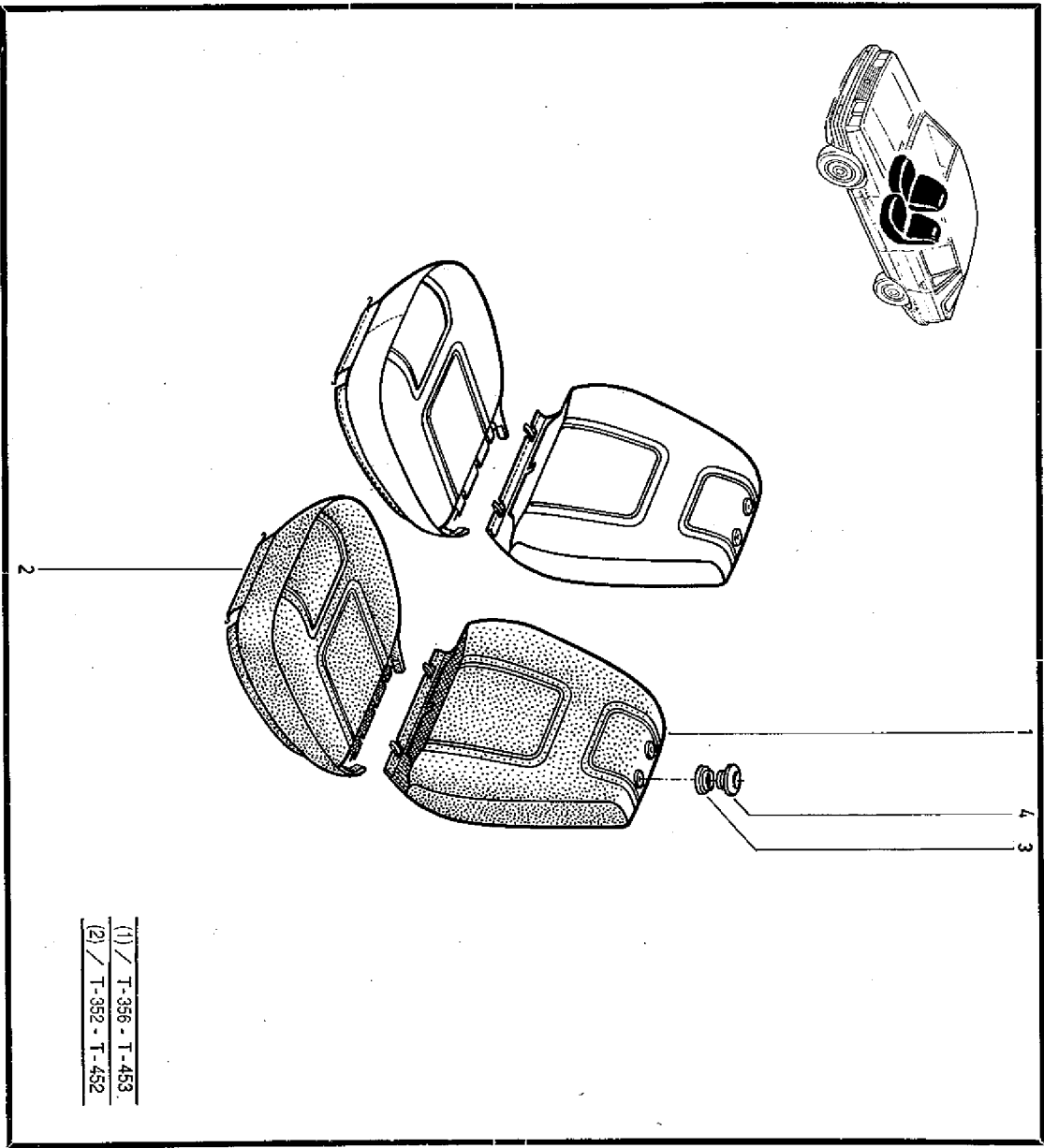

77.10.2
C.R.1037



(1) / T-356 - T-453
 (2) / T-352 - T-452

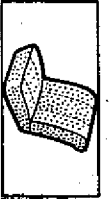

78.10
C.R.1037

- 1 - 77 02 082 240 ~~191~~ (a)
- 77 02 082 241 ~~191~~ (a)
- 77 02 090 959 ~~191~~ (b)
- 77 02 090 960 ~~191~~ (b)
- 77 02 092 827 ~~191~~ (c)
- 77 02 092 828 ~~191~~ (c)
- 2 - 77 02 082 236 ~~191~~ (a) (b)
- 77 02 082 237 ~~191~~ (a) (b)
- 77 02 092 821 ~~191~~ (c)
- 77 02 092 822 ~~191~~ (c)
- 3 - 77 03 081 029
- 4 - 77 00 718 789 (a)
- 77 00 678 581 (b)

B372 B37G

78.10
C.R.1037

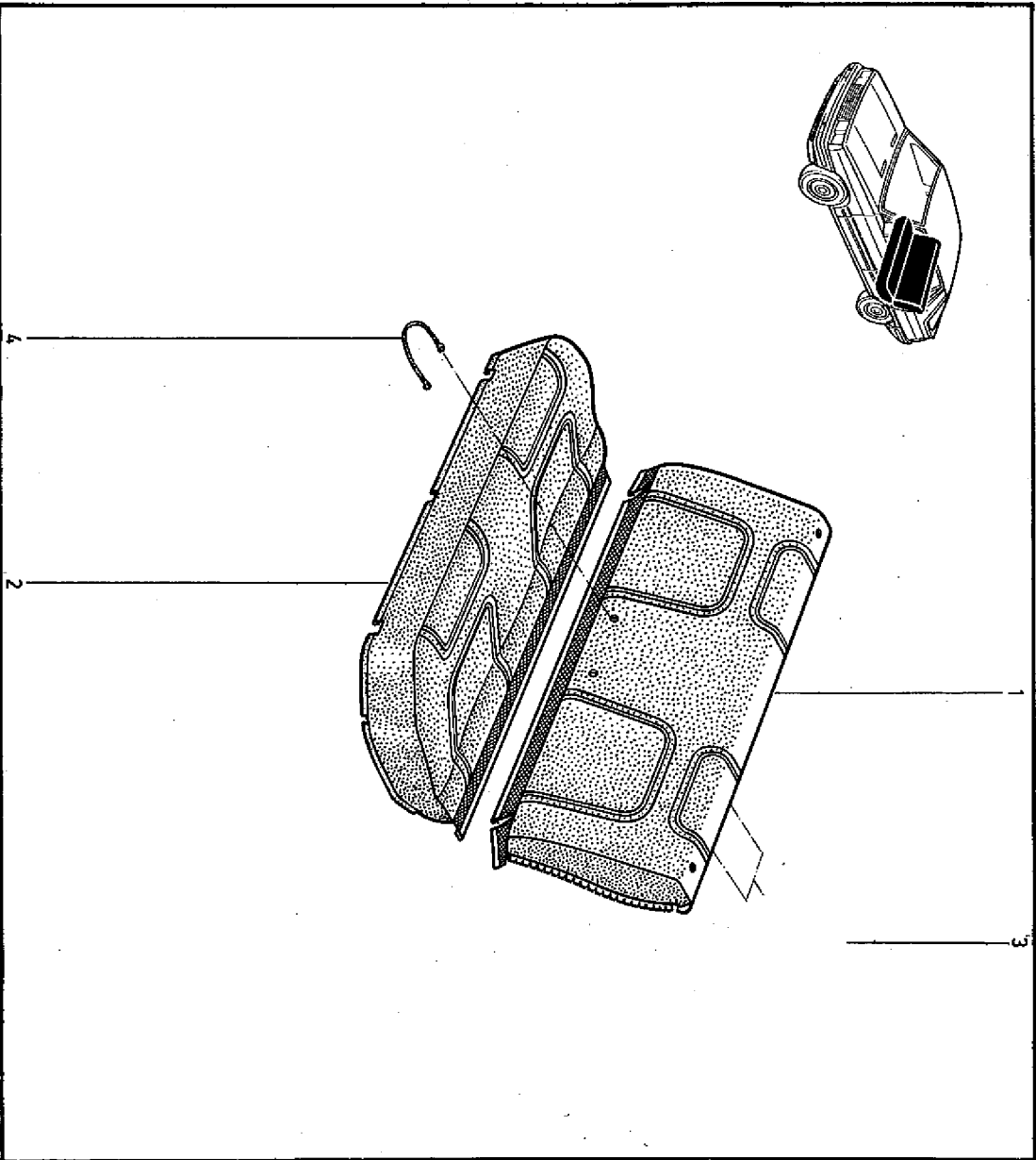
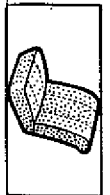

- (a) / B372 ~~191~~ n° 1 ~~191~~ n° 06873
- (b) / B372 ~~191~~ n° 06874 ~~191~~ n°
- (c) / B37G ~~191~~ n° 1 ~~191~~ n°



78.10.1
C.R.1037

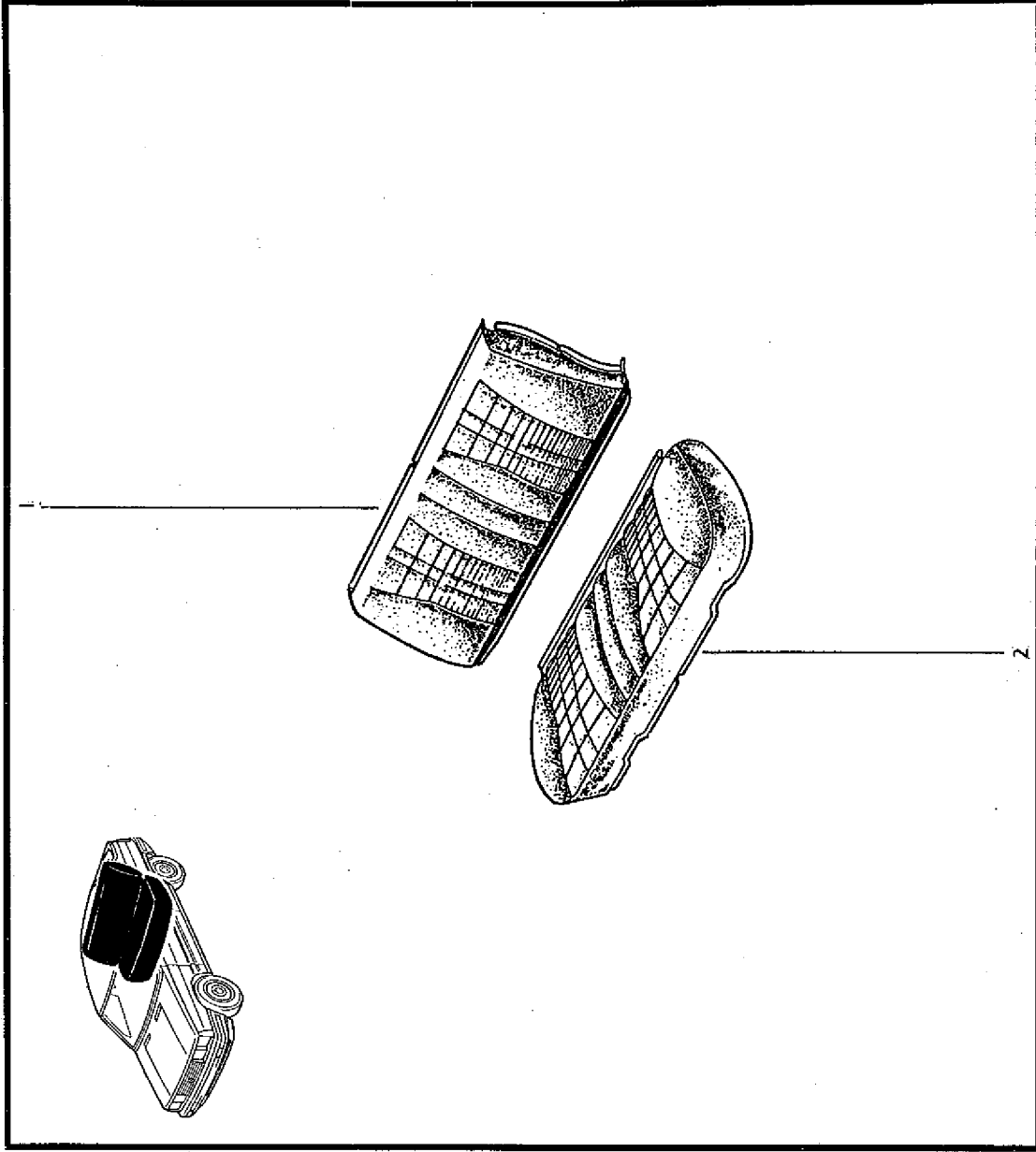

78.10.1
C.R.1037



- 1 - 77 02 204 777 2x1
- 77 02 204 778 2x1
- 2 - 77 02 204 775 2x1
- 77 02 204 776 2x1

B37 G 2x1 n° 6621 → n°



78.10.2
C.R.1037

- 1 - 77 02 210 976 (2) (1)
- 77 02 210 975 (2) (2)
- 2 - 77 02 210 974 (2) (1)
- 77 02 210 973 (2) (2)

B876 n° 9232 → n°.....

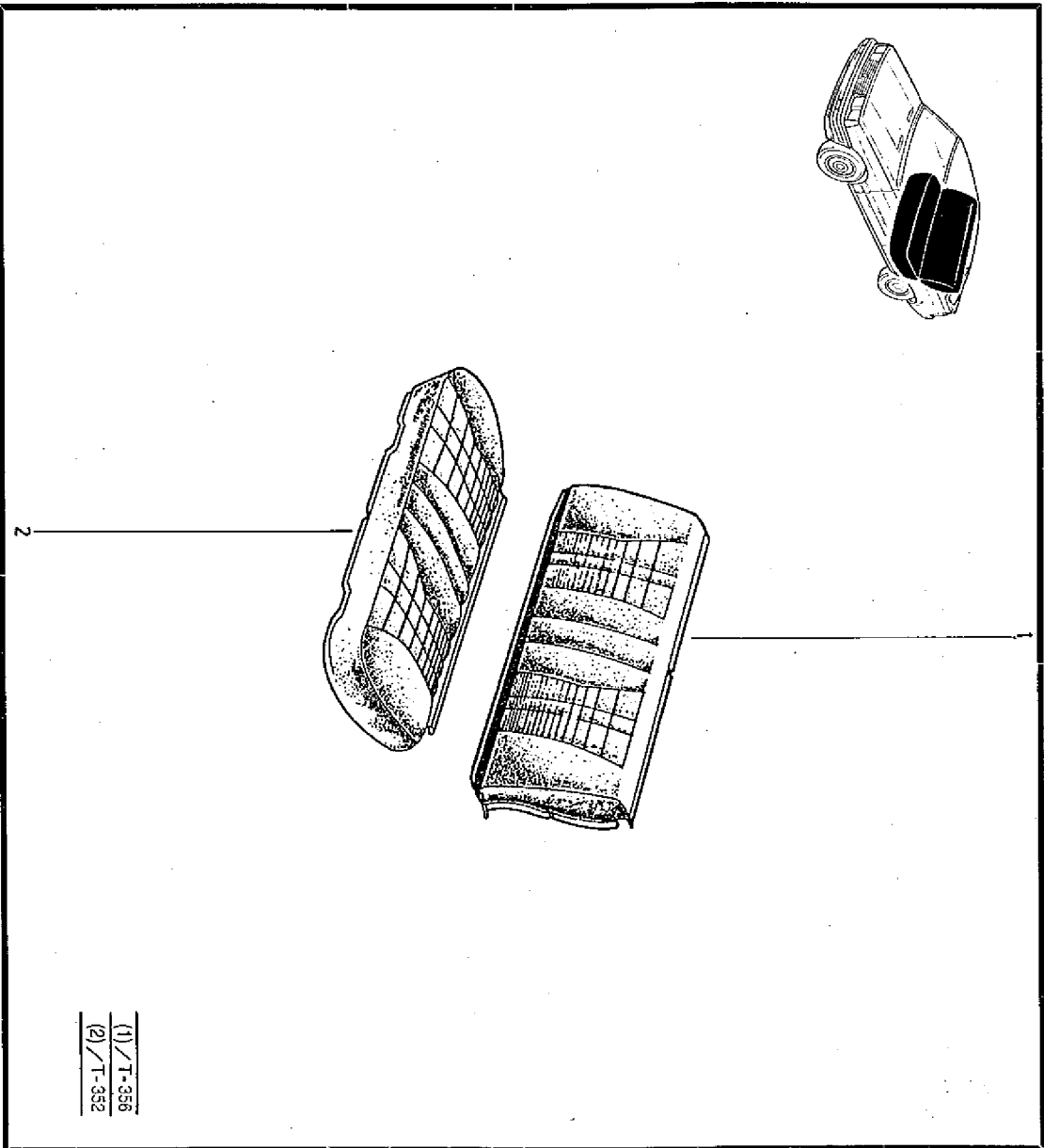

78.10.2
C.R.1037



(1) / T-356
(2) / T-332



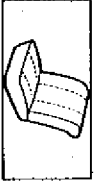

78.11
C.R.1037

- 1 - 77 02 082 256 型 #
- 77 02 082 170 型 (a)
- 77 02 082 282 型 #
- 77 02 082 171 型
- 77 02 092 825 型 (b)
- 77 02 092 826 型 (b)
- 2 - 77 02 082 257 型 #
- 77 02 082 168 型 (a)
- 77 02 082 261 型 #
- 77 02 082 169 型 (a)
- 77 02 092 823 型 (b)
- 77 02 092 824 型 (b)
- 3 - 77 02 082 256 型 #
- 77 02 082 166 型 (a)
- 77 02 082 260 型 #
- 77 02 082 167 型 (a)
- 77 02 092 819 型 (b)
- 77 02 092 820 型 (b)
- 4 - 77 02 082 256 型 #
- 77 02 082 164 型 # (a)
- 77 02 082 259 型 #
- 77 02 082 165 型 (a)
- 77 02 092 817 型 (b)
- 77 02 092 818 型 (b)
- 5 - 77 03 081 029
- 6 - 77 00 678 581

B373

78.11
C.R.1037

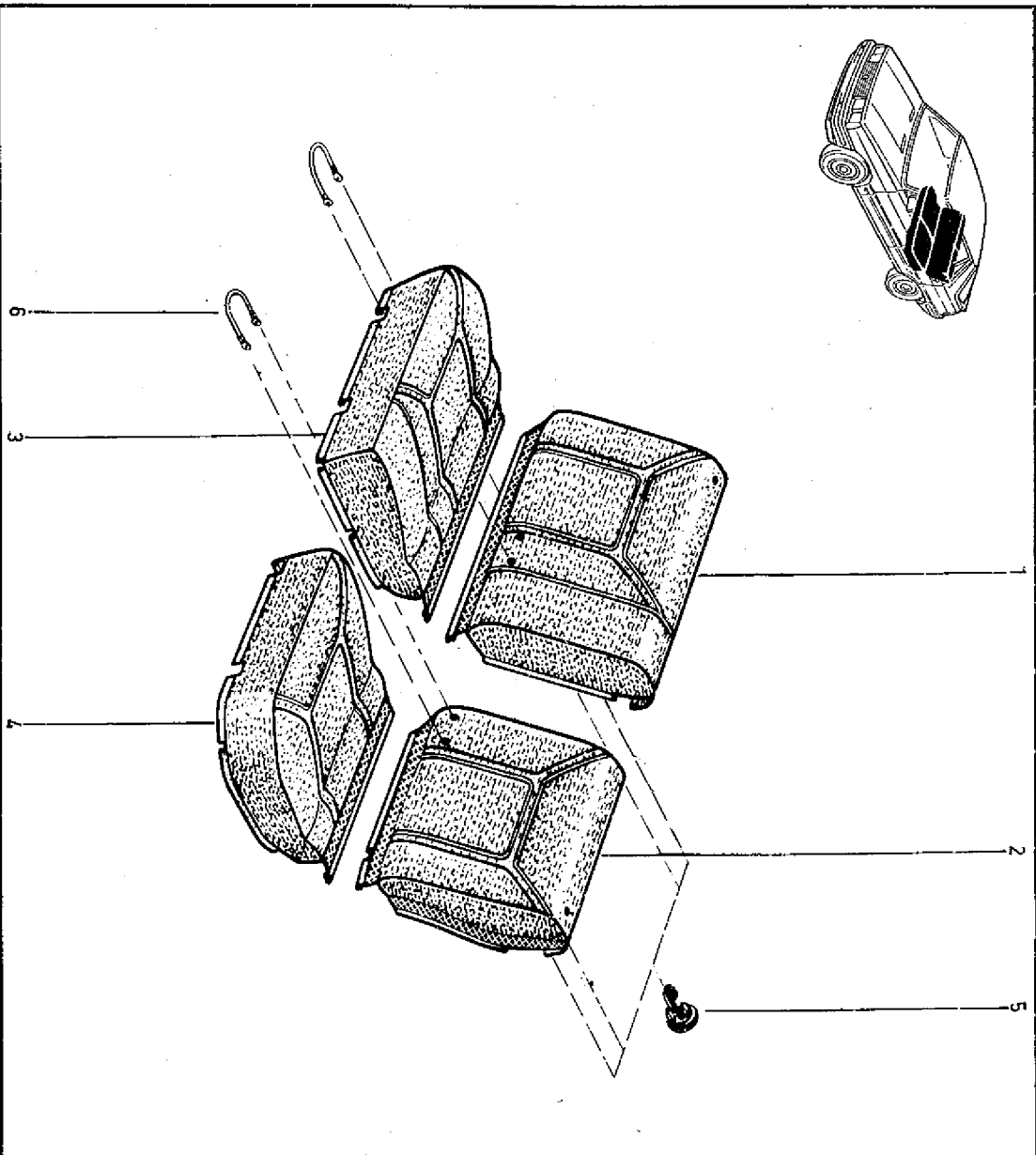
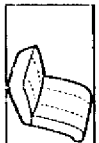

(a) B373 n° 1
 (b) B373 n° 16884



78.12
C.R.1037

- 1 - 77 02 090 860 I1 (a)
- 77 02 095 765 I1 (b)
- 2 - 77 02 090 859 I1 (a)
- 77 02 095 764 I1 (b)
- 3 - 77 02 090 862 I1 (a)
- 77 02 095 763 I1 (b)
- 4 - 77 02 090 861 I1 (a)
- 77 02 095 762 I1 (b)

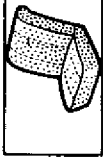

78.12
C.R.1037

B375 B37E

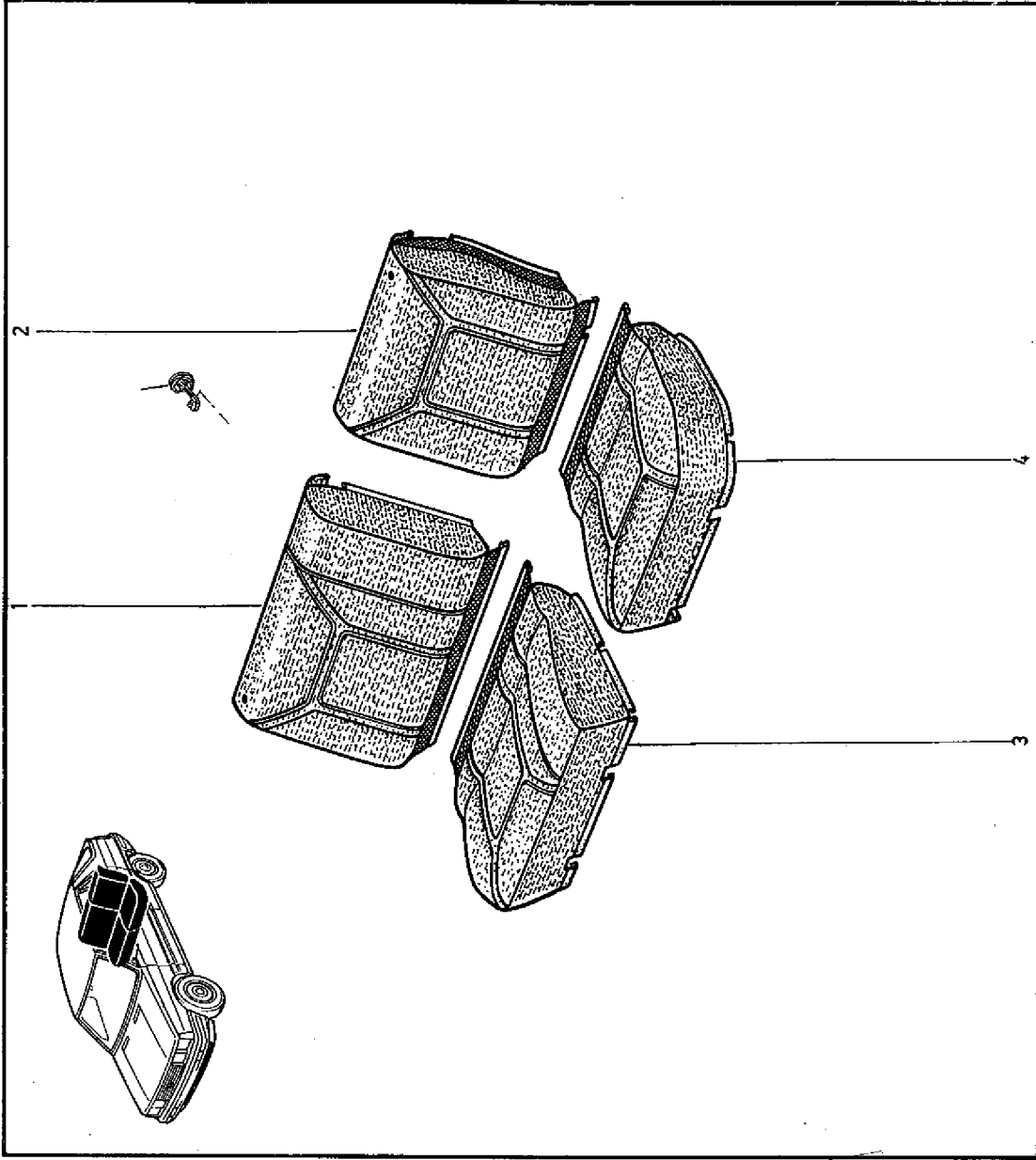

(a) B375
(b) B37E

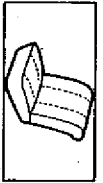

78.12.1
C.R.1037

- 1- 77 02 204 784 (a) (a)
- 77 02 204 786 (a) (d)
- 77 02 210 655 (a) (e)
- 77 02 208 464 (a) (b)
- 77 02 208 465 (a) (b)
- 77 02 204 241 (a) (c)
- 2- 77 02 204 783 (a) (a)
- 77 02 204 785 (a) (d)
- 77 02 210 654 (a) (e)
- 77 02 208 462 (a) (b)
- 77 02 208 463 (a) (b)
- 77 02 204 239 (a) (c)
- 3- 77 02 204 780 (a) (a)
- 77 02 204 782 (a) (d)
- 77 02 210 653 (a) (e)
- 77 02 208 458 (a) (b)
- 77 02 208 459 (a) (b)
- 4- 77 02 204 240 (a) (c)
- 77 02 204 779 (a) (d)
- 77 02 210 652 (a) (e)
- 77 02 208 456 (a) (b)
- 77 02 208 457 (a) (b)
- 77 02 204 238 (a) (c)
- 5- 77 05 081 029 (c)
- 3- 77 00 578 581 (c)

- (a) B371 ~~1~~ n° 1 → n°
- (b) B373 ~~1~~ n° 30734 → n°
- (c) B375 ~~1~~ n° 732 → n°
- (d) B377 ~~1~~ n° 1 → n° 953
- (e) B321 ~~1~~ n° 954 → n°

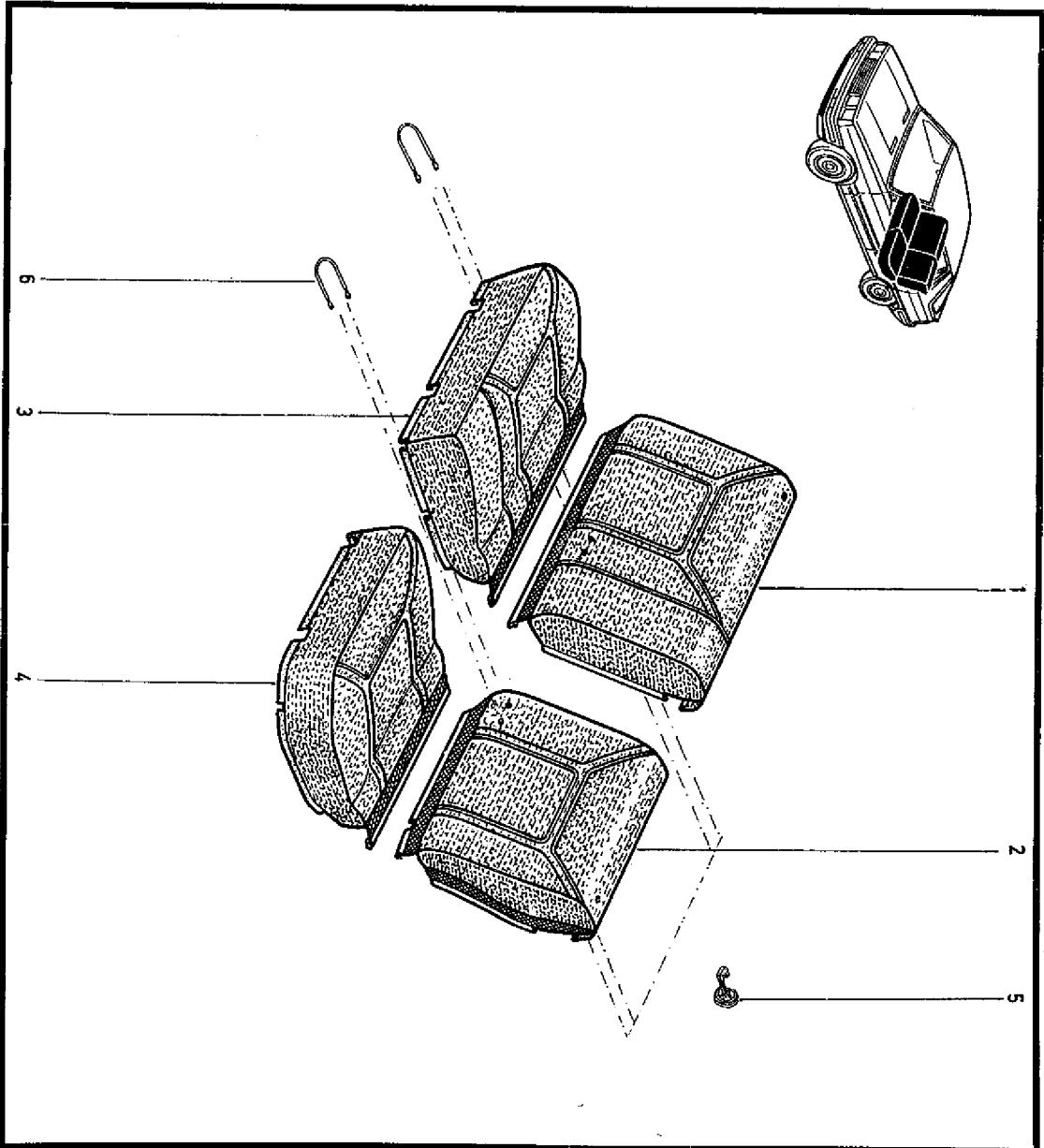

78.12.1
C.R.1037





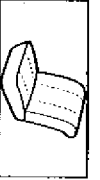

79.01
C.R.1037

- 1 - 77 02 082 172 罐 (a)
- 77 02 082 173 罐 (a)
- 77 02 092 897 罐 (b)
- 77 02 092 898 罐 (b)
- 2 - 77 02 082 190 罐 (a)
- 77 02 082 191 罐 (a)
- 3 - 77 01 349 642
- 77 00 763 502
- 4 - 77 00 646 134
- 77 00 763 387

B373

79.01
C.R.1037

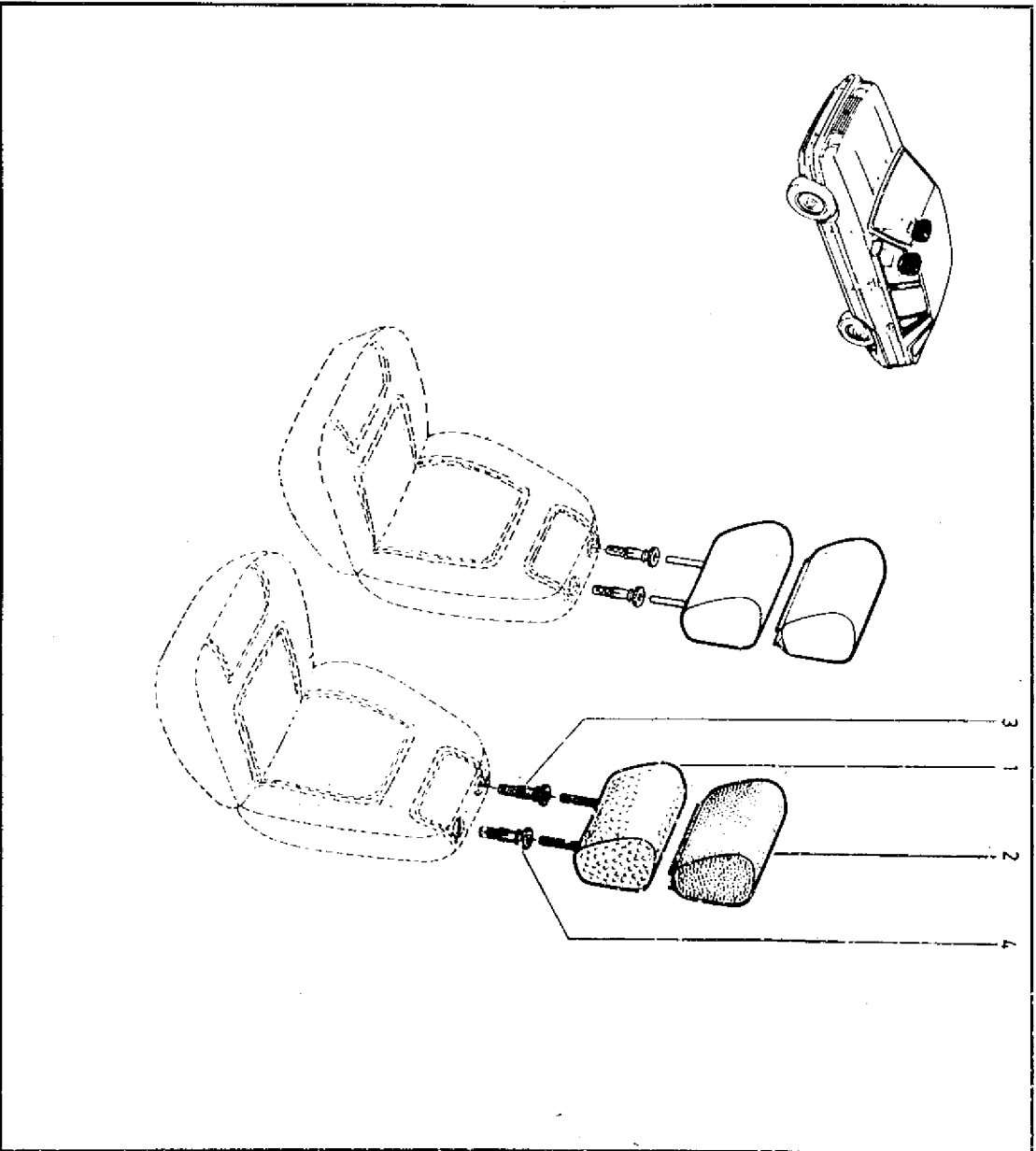

- (a) B373 罐 n° 1 罐 n°16883
- (b) B373 罐 n°16884 罐 n°



79.02
C.R.1037

- 1 - 77 02 090 906 (a)
- 77 02 095 766 (b)
- 2 - 77 02 090 905 (a) †
- 3 - 77 00 763 502
- 4 - 77 00 763 387



79.02
C.R.1037

B37E B375

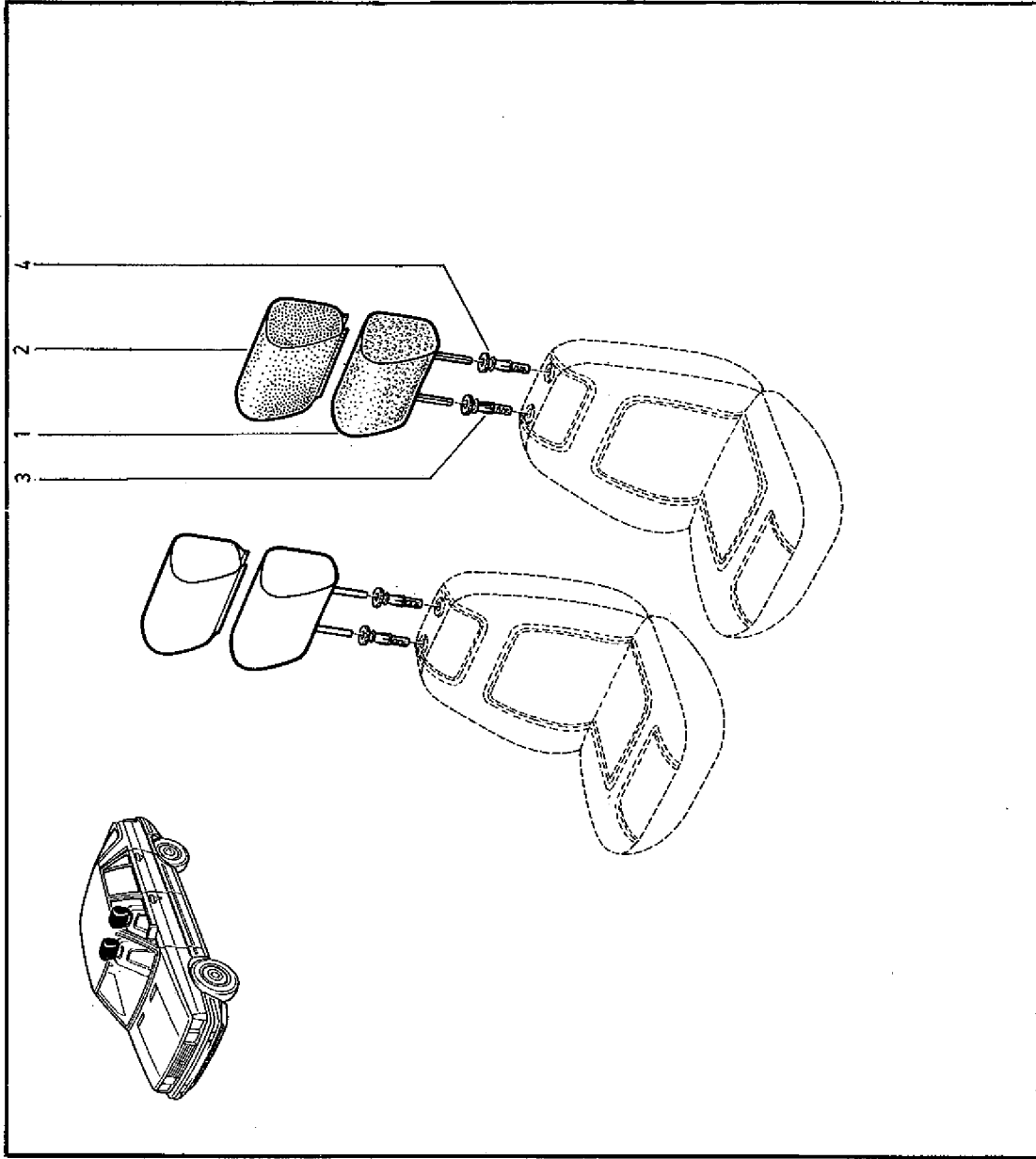

(a) B375
(b) B37E



79.03.1

C.R.1037

- 1- 77 02 095 955 (a)(c)(d)
- 77 02 204 789 (a)(c)
- 77 02 204 790 (a)(c)
- 77 02 204 301 (a)(b)
- 77 02 204 302 (a)(b)
- 2- 77 00 763 387
- 3- 77 00 763 502

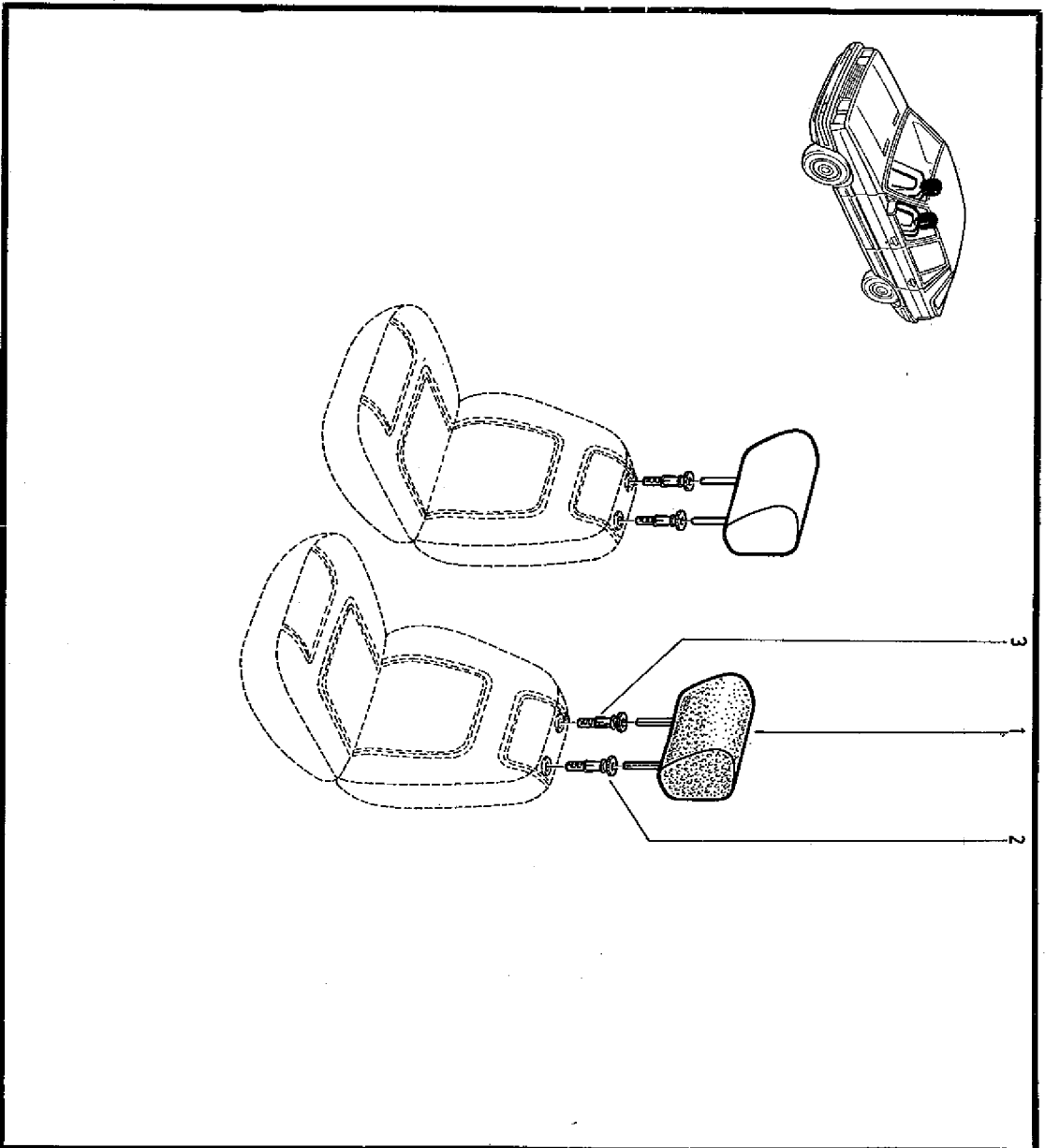

79.03.1

C.R.1037

(a)	B37T	E2	n° 1	→	n° 953
(b)	B37G	E2	n° 6621	→	n°
(c)	B373	E2	n° 30734	→	n°
(d)	B37T	E2	n° 954	→	n°



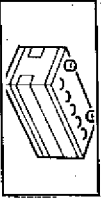

80.01
C.R.1037

- 1 - 02 24 877 500
- 2 - 08 55 947 200
- 3 - 08 55 664 400
- 4 - 77 00 709 890
- 5 - 77 00 750 185
- 6 - 77 03 033 024
- 7 - 77 03 080 032
- 8 - 77 00 723 324
- 9 - 77 00 756 787
- 10 - 77 05 026 622

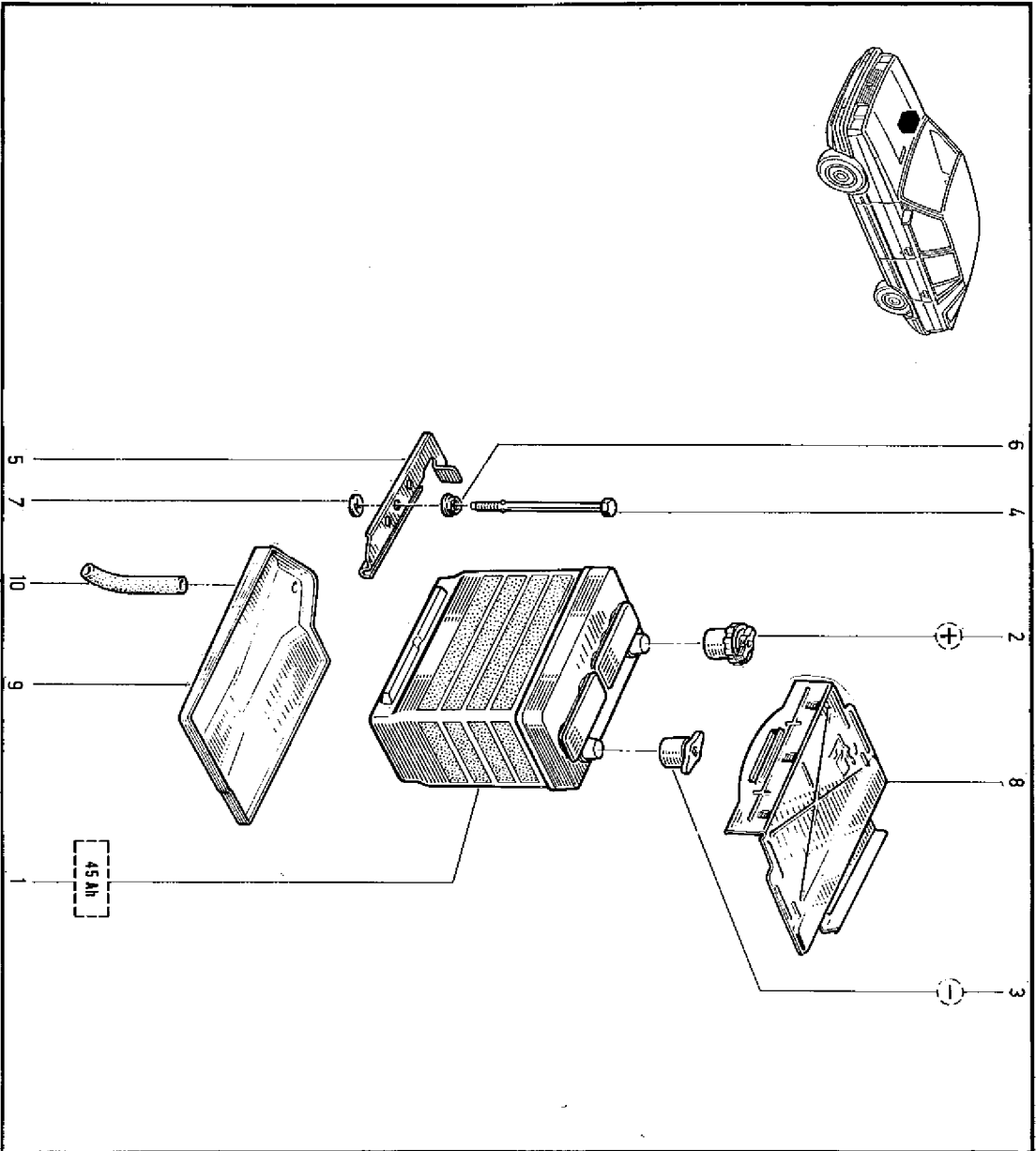

80.01
C.R.1037

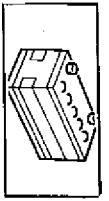



80.20
C.R.1037

- 1 - 77 02 073 789
- 2 - 77 02 073 790
- 3 - 77 02 073 791
- 4 - 77 02 073 792
- 5 - 77 02 073 793
- 6 - 77 02 073 794
- 7 - 77 02 073 795
- 8 - 77 02 073 796
- 9 - 77 02 088 590
- 10 - 77 03 079 072
- 11 - 77 02 073 787
- 12 - 77 02 206 080
- 13 - 77 02 206 081

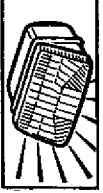

80.20
C.R.1037

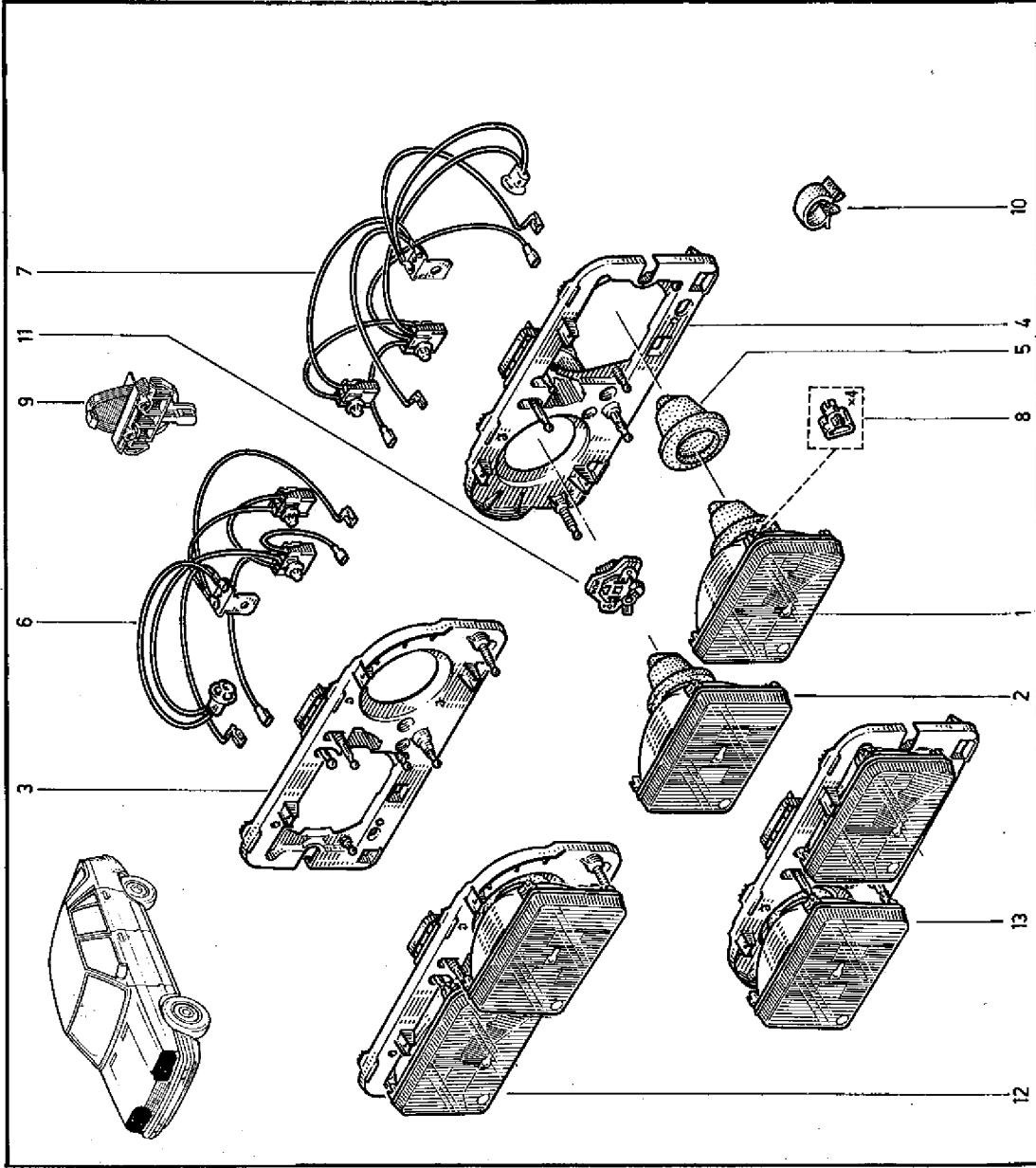



80.25
C.R.1037

- 1 - 77 02 082 671 (A) (a)
- 77 02 082 735 (B) (a)
- 77 02 072 379 (b) (A)
- 77 02 072 894 (b) (B)
- 2 - 77 02 073 422 (A)
- 77 02 089 326 (B)
- 3 - 77 02 073 421 (A)
- 77 02 089 325 (B)

(a) B375
(b) B37E

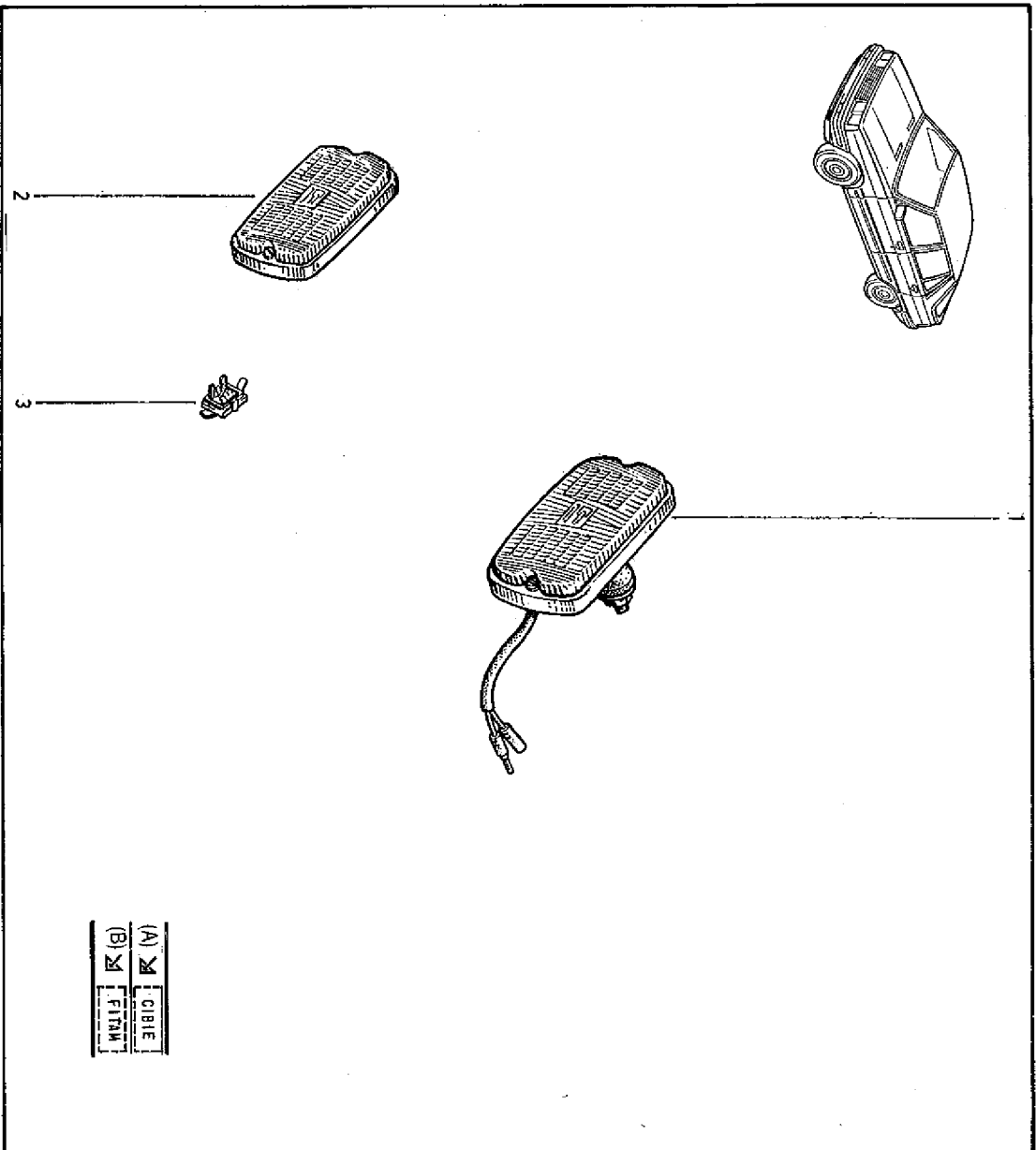

B375 - B37E

80.25
C.R.1037



(A) CIBIE
(B) FITM



80.30
C.R.1037

- 1 - 77 00 752 564
- 2 - 77 00 678 531
- 3 - 77 03 033 009
- 4 - 77 00 515 140



80.30
C.R.1037

B375

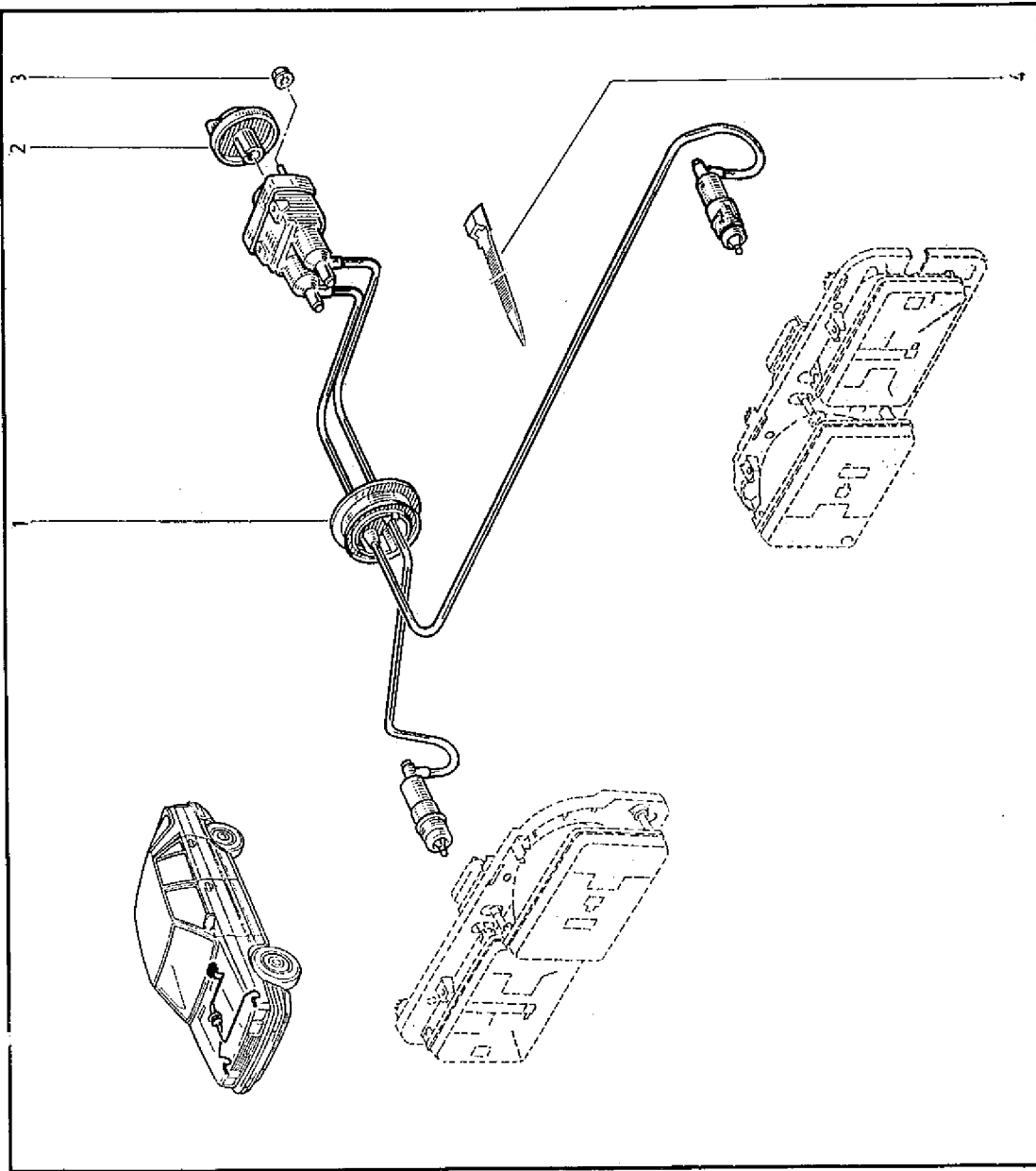

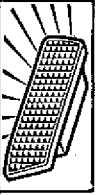

1 - 77 01 029 281 +
77 02 088 626
2 - 77 01 029 282 +
77 02 088 627

80.40
C.R.1037

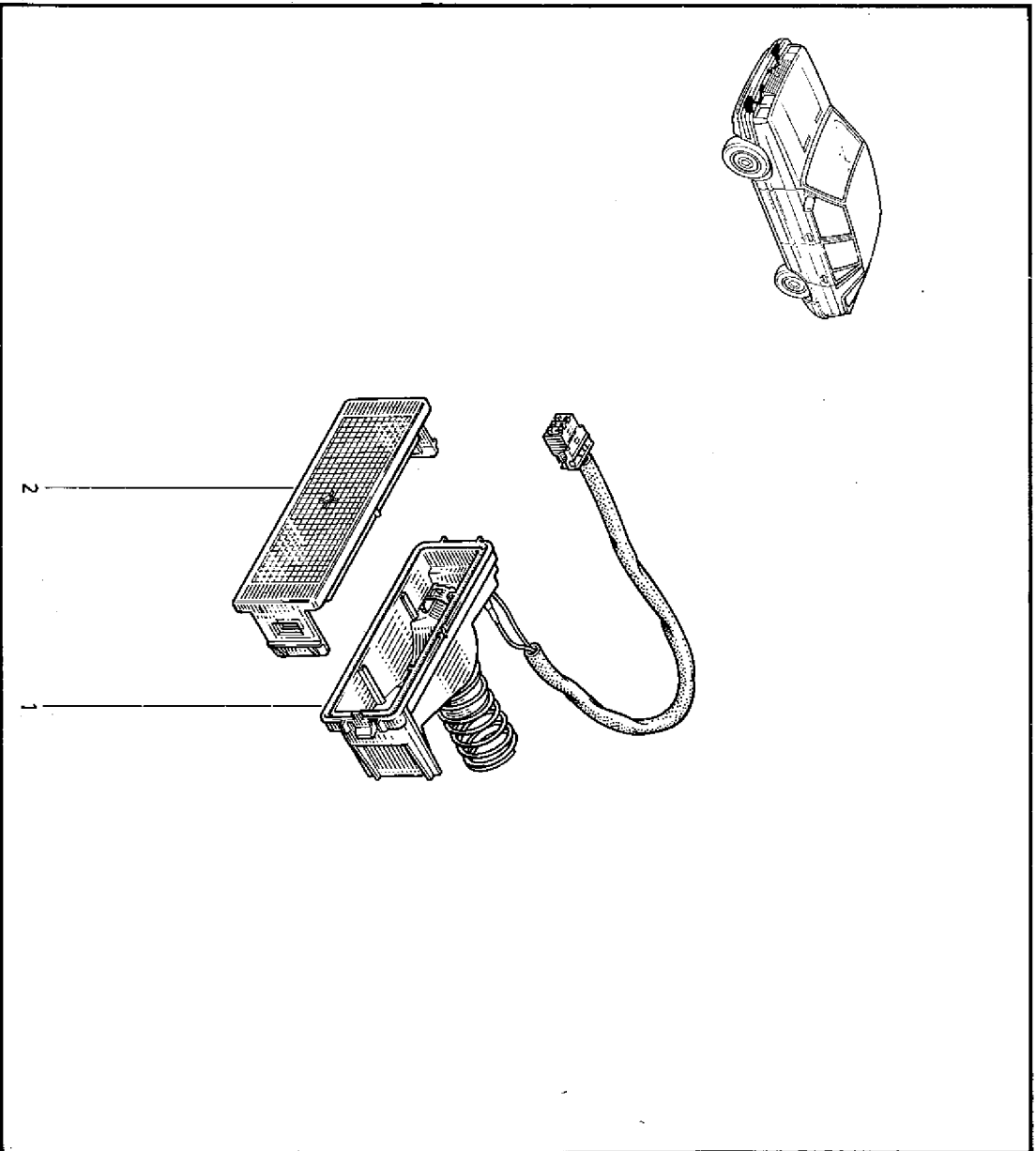

80.40
C.R.1037

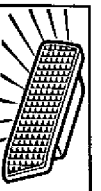

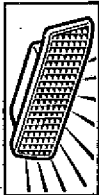

81.01
C.R.1037

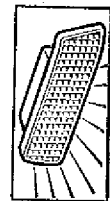
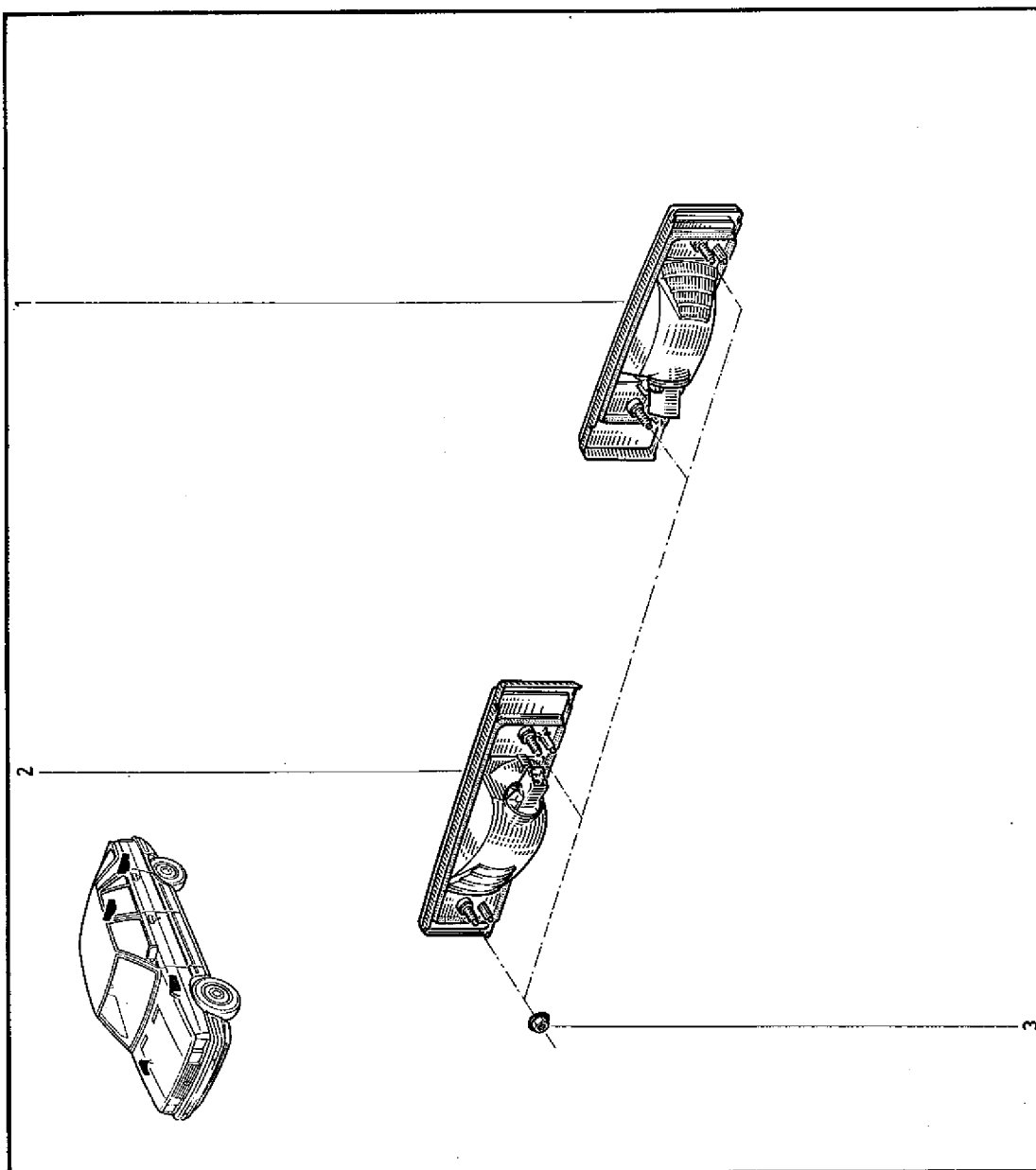

81.01
C.R.1037

- 1 - 77 01 349 601 †
- 77 00 750 858
- 2 - 77 01 349 602 †
- 77 00 750 859
- 3 - 77 03 083 022 †
- 77 03 033 043

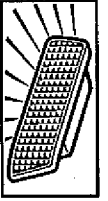

81.10
C.R.1037

- 1 - 77 01 029 309 (A)
77 02 082 567 +
- 2 - 77 01 029 053 (B) +
77 01 029 311 (A) +
77 01 029 054 (B) +
- 3 - 77 01 029 568 +
77 01 029 310 (A) +
77 02 088 881
- 4 - 77 01 029 312 (A)
77 01 029 056 (B) +
77 02 088 882
- 5 - 77 03 033 022 +
77 03 033 043
- 6 - 77 02 206 208
- 7 - 77 02 206 207

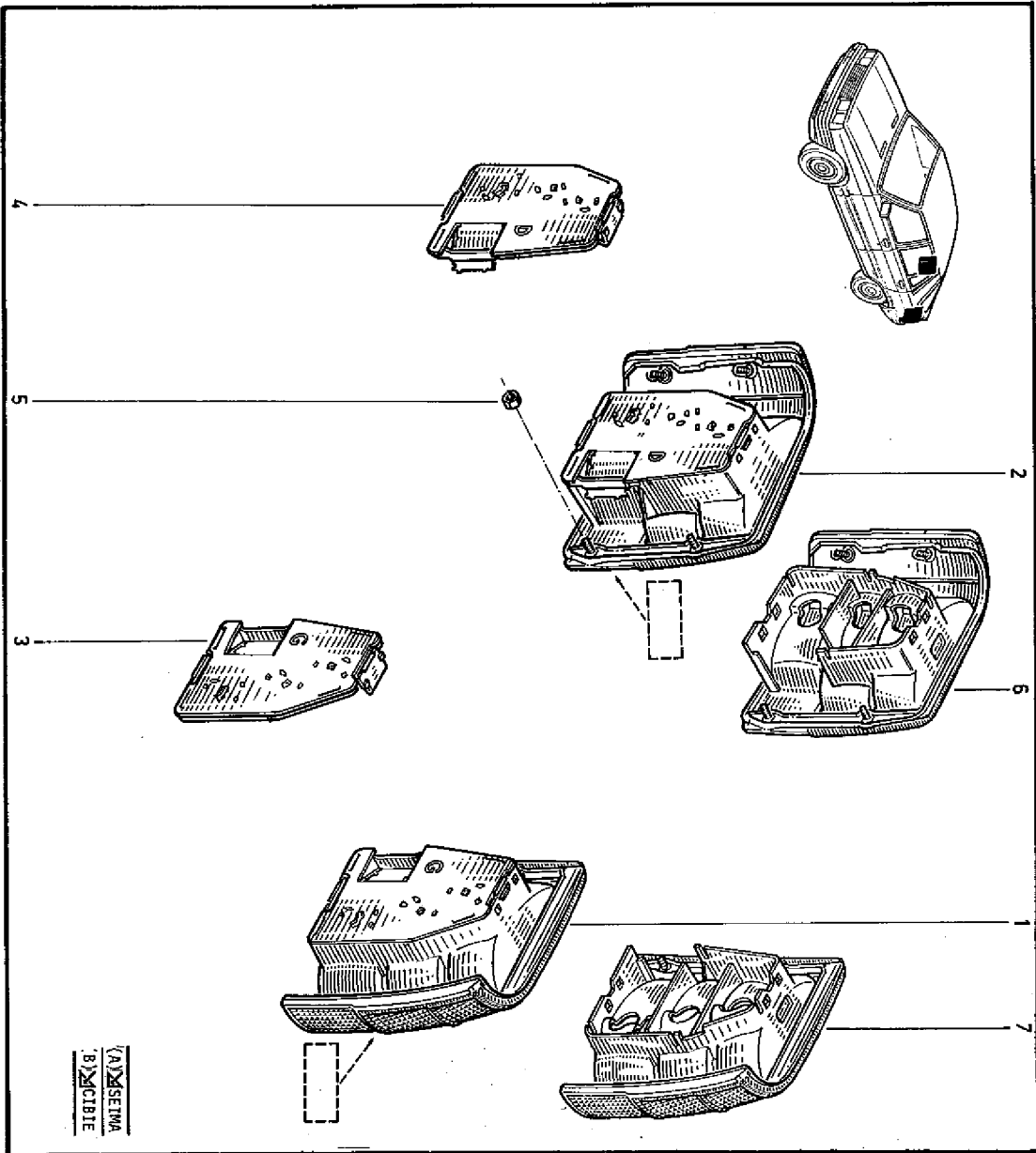

81.10
C.R.1037

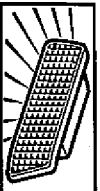

ALPESINA
BMCIBTE



81.20
C.R.1037

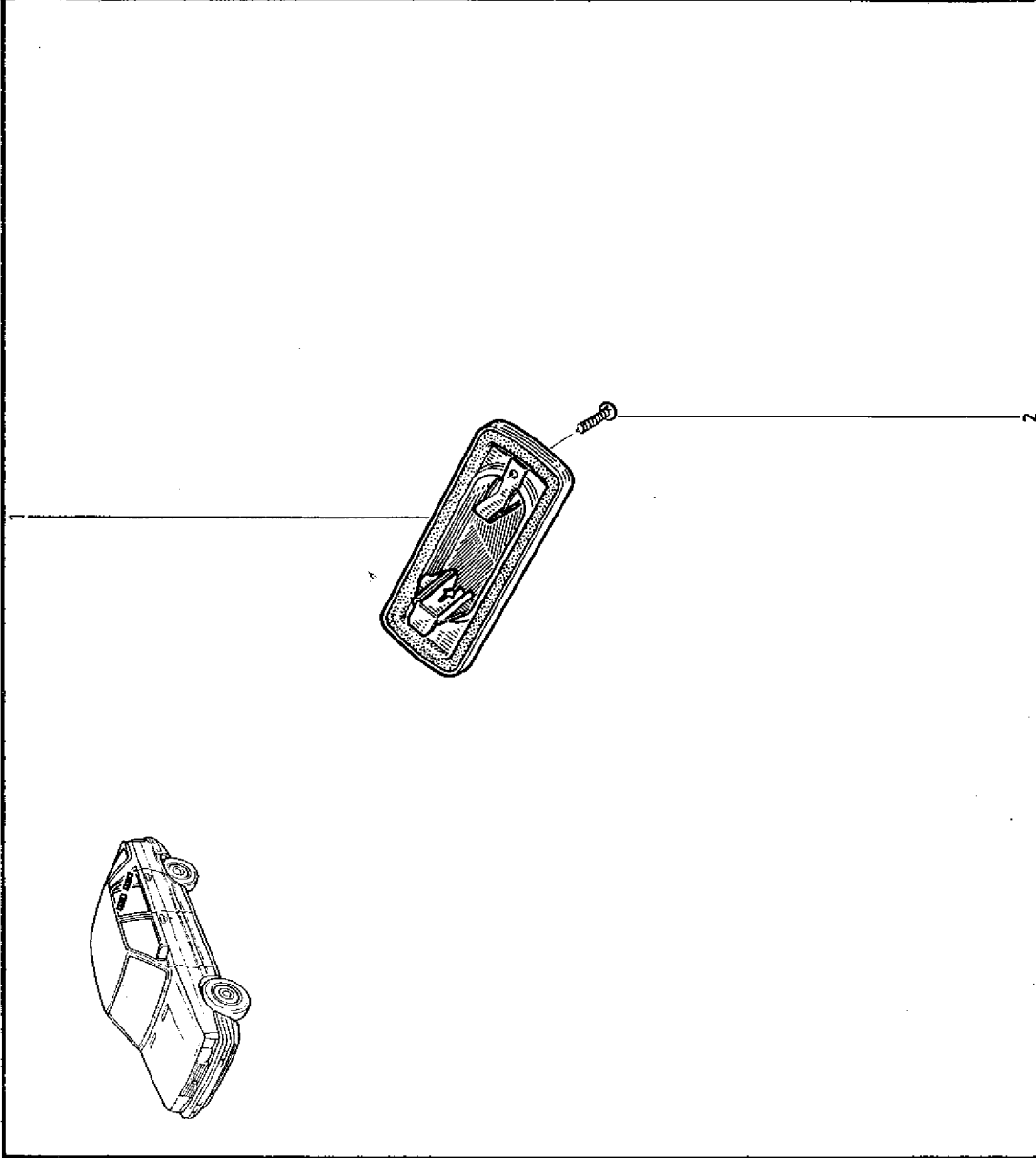

81.20
C.R.1037

1 - 77 02 072 030
2 - 77 03 016 256

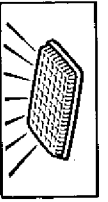

81.40
C.R.1037

- 1 - 77 03 016 307
- 2 - 77 02 061 970
- 3 - 77 01 348 991
- 4 - 77 02 082 066
- 5 - 77 01 349 465 (a) †
- 77 01 366 103 (a)
- 77 02 082 571 (a)
- 77 01 365 904 (a) †
- 77 01 349 730 (a) †
- 77 01 366 104
- 77 02 082 572 (a)
- 77 02 072 944 (a)
- 6 - 77 01 349 356 (a) †
- 77 01 349 728 (a)
- 77 02 082 569 (a)
- 77 01 349 500 (a) †
- 77 01 349 729 (a)
- 77 02 082 570 (a)
- 77 02 072 947 (a)
- 7 - 77 00 751 798
- 77 02 082 574

(a) MB373 B37E B37S

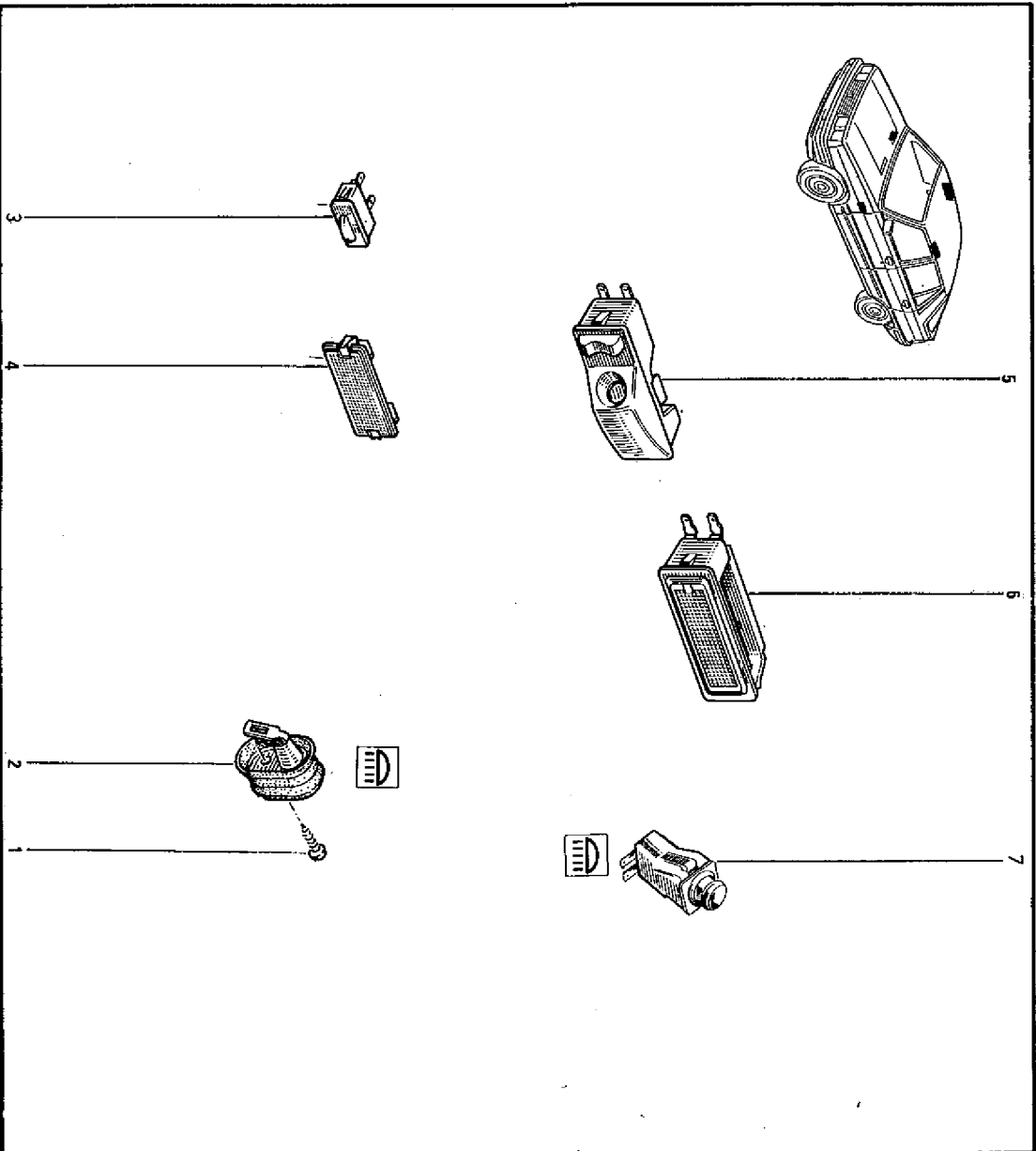

81.40
C.R.1037

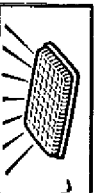

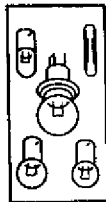

81.50
C.R.1037

- 1 - 77 03 097 176
- 2 - 0454646 +
77 03 097 178
- 3 - 0454645 +
77 03 097 179
- 4 - 77 03 097 181
- 5 - 77 03 097 183
09 90 003 600
- 6 - 77 03 097 182
- 7 - 77 03 097 185
- 8 - 77 03 097 184
- 9 - 77 01 998 052 131
- 10 - 77 01 998 056 183
- 11 - 77 01 998 057 261
- 12 - 77 01 998 053 186
- 13 - 77 01 998 058 171
- 14 - 77 01 998 059 181
- 15 - 77 01 998 054 131
- 16 - 77 03 097 387
- 17 - 77 01 998 065 180

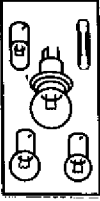

81.50
C.R.1037

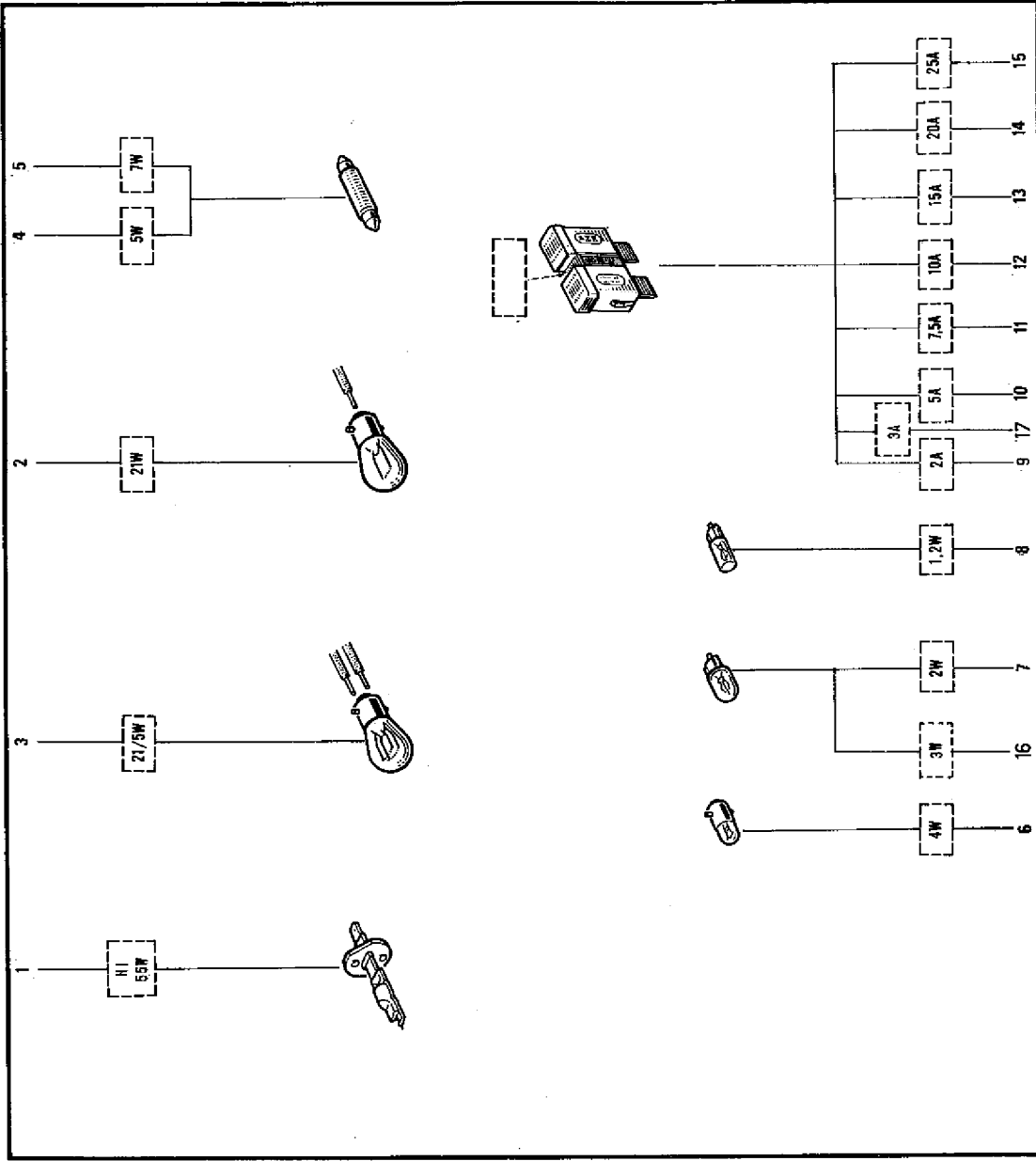

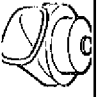

82.01
C.R.1037

- 1 - 77 02 082 507
- 77 02 082 789
- 2 - 77 02 082 506
- 77 02 082 790
- 3 - 77 02 073 743
- 4 - 79 03 082 018
- 5 - 77 03 019 017

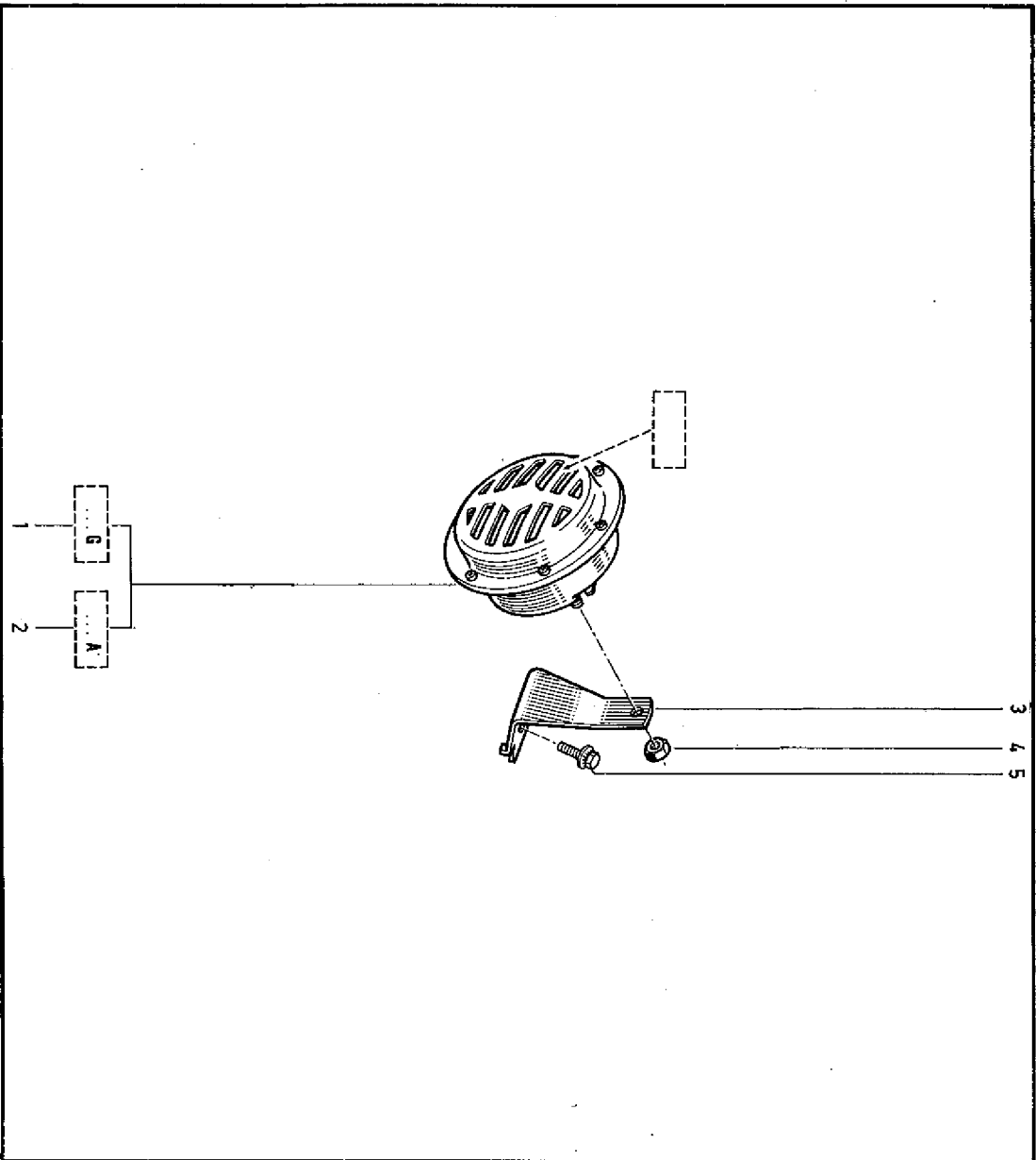

82.01
C.R.1037





83.01
C.R.1037

B37Z B37G

83.01
C.R.1037

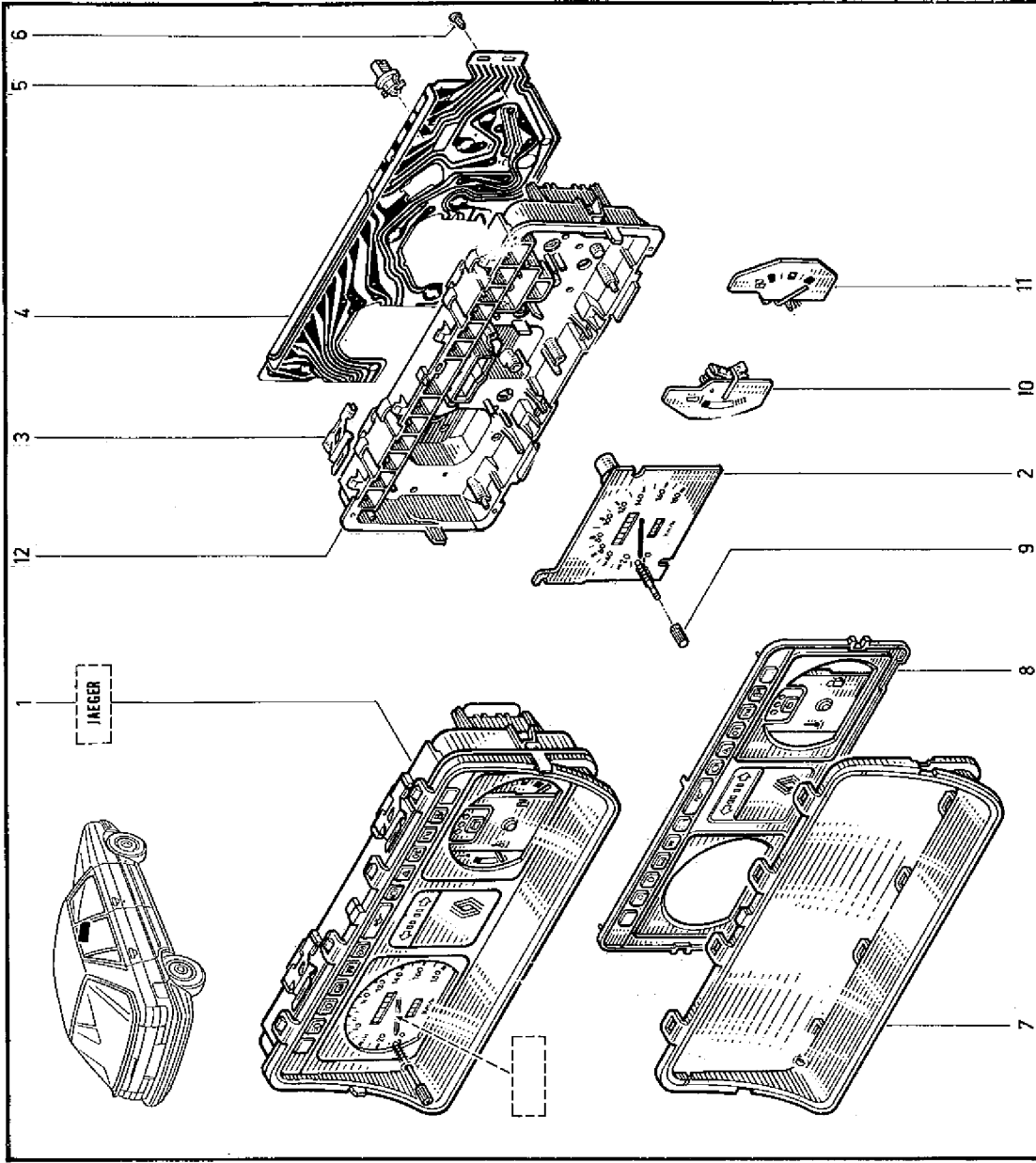
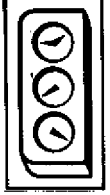

- 1 - 77 02 082 590
- 2 - 77 02 073 912
- 3 - 77 01 012 548
- 4 - 77 02 073 915
- 5 - 77 01 348 570
- 6 - 77 01 022 969
- 7 - 77 02 073 916
- 8 - 77 02 073 926
- 9 - 77 02 073 917
- 10 - 77 02 073 914
- 11 - 77 02 073 913
- 12 - 77 02 073 911

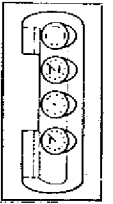

83.05

C.R.1037

- 1 - 77 02 082 591 (a)
- 77 02 082 746 (b)
- 2 - 77 01 025 323 (a)
- 77 01 025 368 (b)
- 3 - 77 01 012 548
- 4 - 77 01 025 324 (a)
- 77 01 025 356 (b)
- 5 - 77 01 022 969
- 6 - 77 01 348 570
- 7 - 77 00 544 419
- 8 - 77 02 073 909 (a)
- 77 01 025 327 (b)
- 9 - 77 01 025 329
- 10 - 77 02 073 718
- 11 - 77 01 025 330
- 12 - 77 01 025 331 (a)
- 13 - 77 01 025 333 (a)
- 77 01 025 340 (b)
- 14 - 77 02 073 910 (a)
- 77 02 089 416 (b)
- 15 - 77 01 024 838
- 16 - 77 03 016 051
- 17 - 77 01 025 326
- 18 - 77 01 022 446 (a)
- 19 - 77 01 025 325 (a)

B373 B37E

83.05

C.R.1037

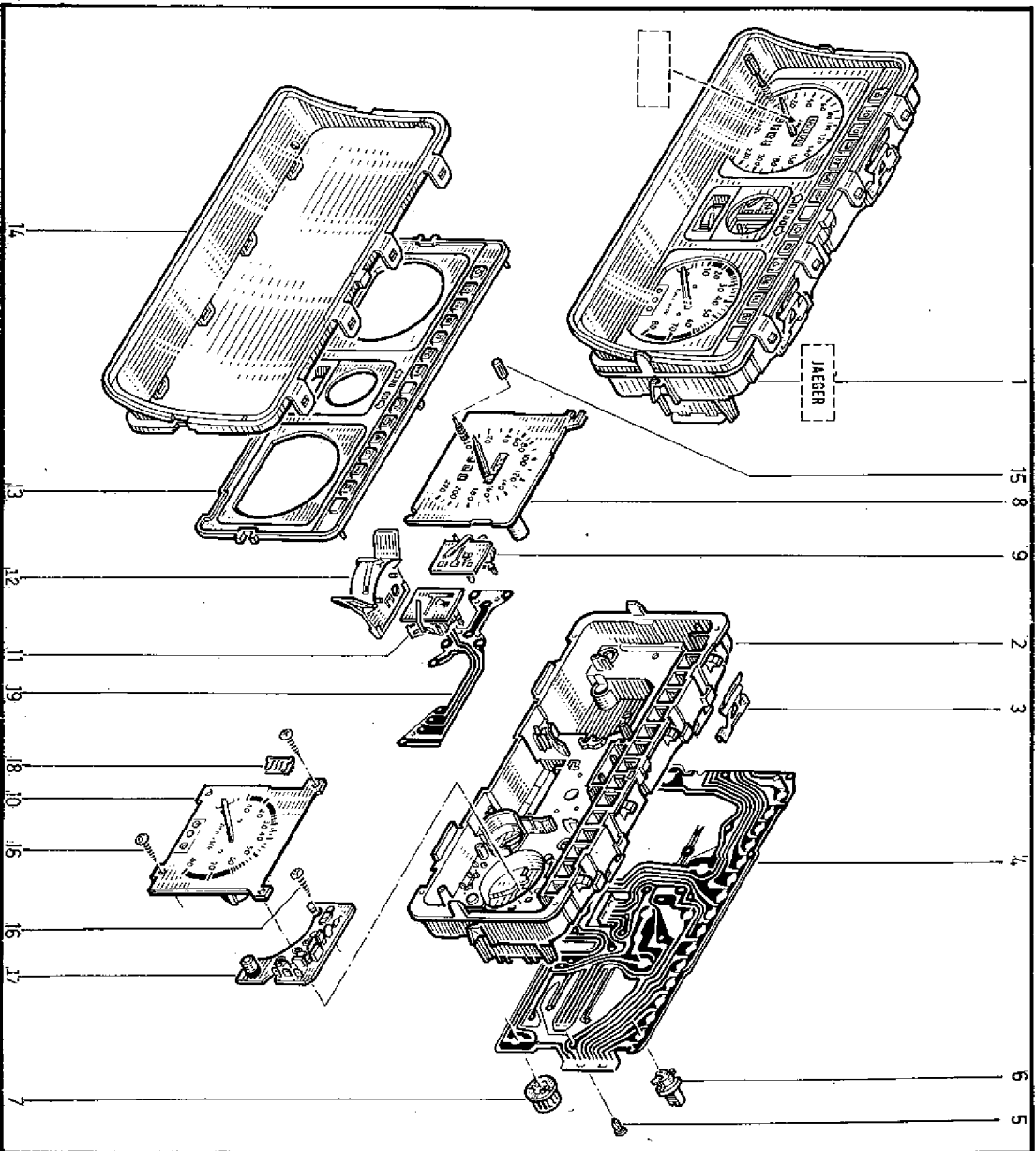
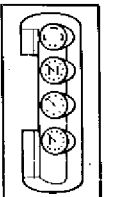

B373 / (a) n° 022197

(b) n° 022198 n°

37E / (a) n° 001295

(b) n° 001296 n°

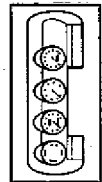

83.06
C.R. 1037

- 1 - 77 00 771 347
- 2 - 77 01 029 835
- 3 - 77 02 088 877
- 4 - 77 01 029 741
- 5 - 77 01 029 838
- 6 - 77 01 029 746
- 7 - 77 02 088 878
- 8 - 77 02 088 879
- 9 - 77 01 031 064
- 10 - 77 01 029 839
- 11 - 77 00 544 419
- 12 - 77 01 948 570
- 13 - 77 02 088 880

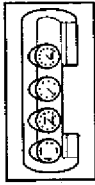

83.06
C.R. 1037

B375

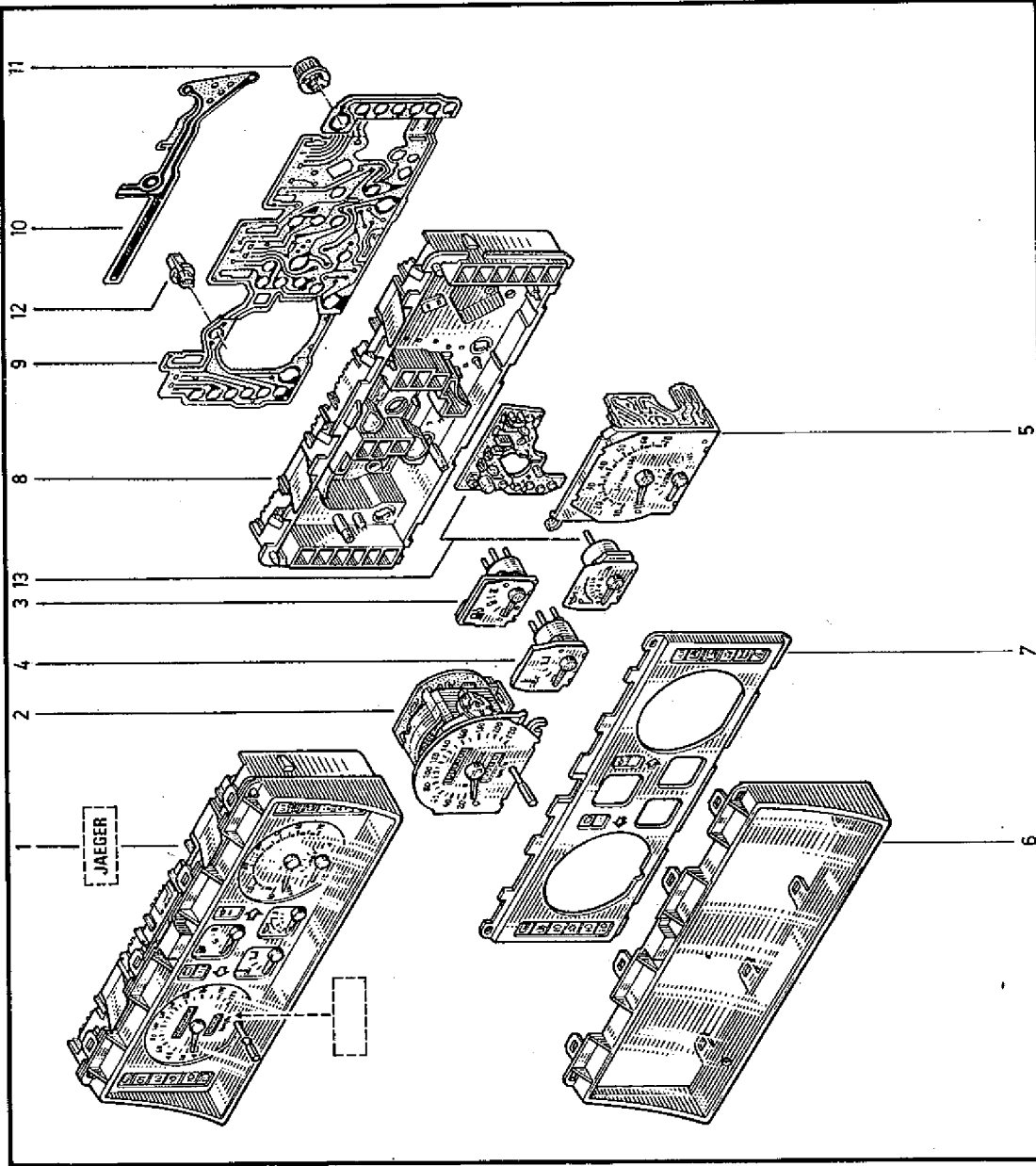

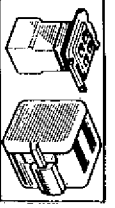

83.08
C.R.1037

- 1 - 77 00 713 016 +
77 00 773 796 (a) +
77 00 773 798 (b) +
77 00 794 652 (c)
77 00 794 653 (d)
- 2 - 77 00 713 017 (a) +
77 00 779 192 (b) +
77 00 794 654 (c) (d)
- 3 - 77 03 101 043

(c) / B37G
B373
B37E
B375

83.08
C.R.1037

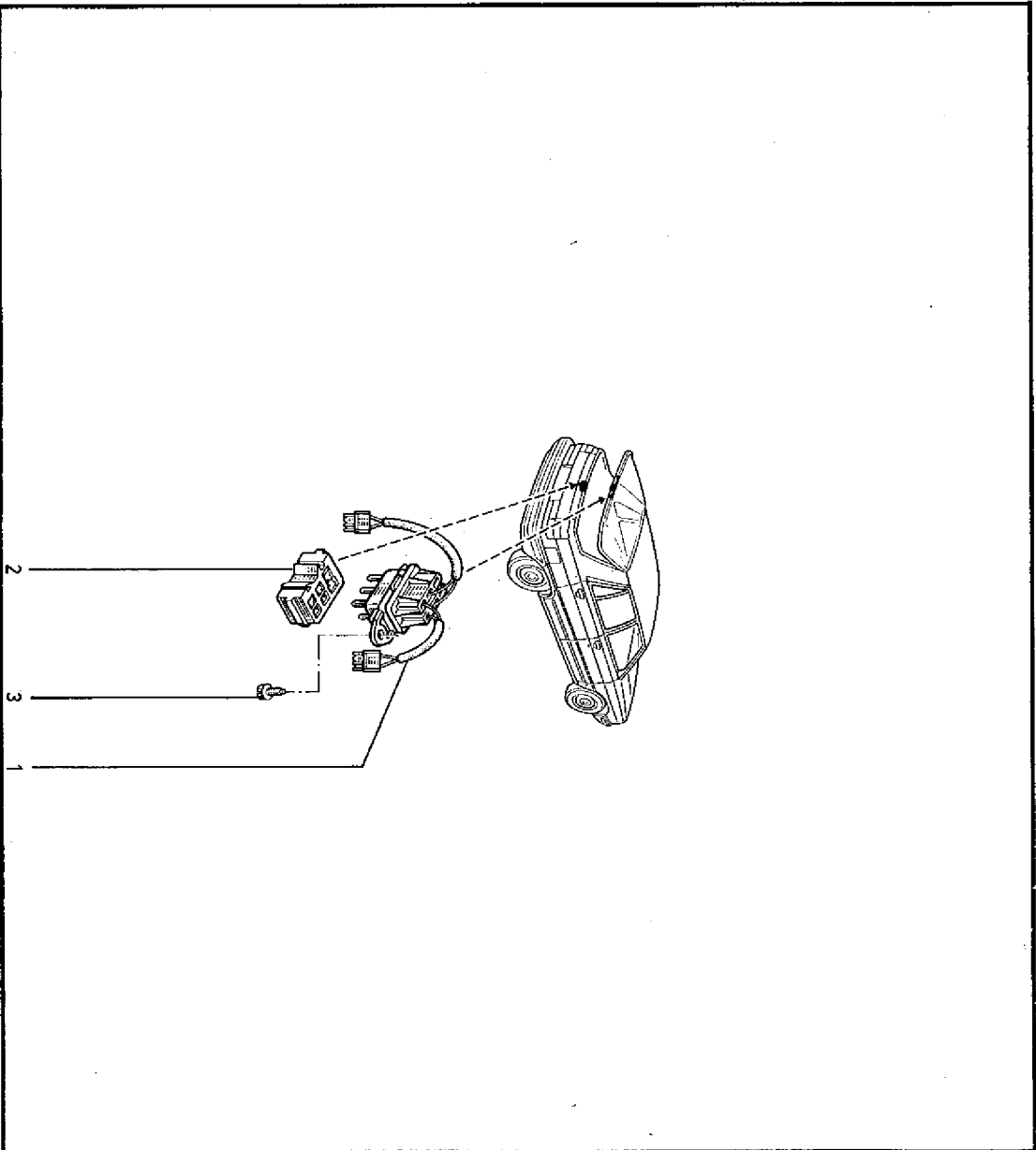
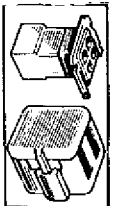

(a) / B372 ~~111~~ n° 1 ⇨ ~~111~~ n°
B373 ~~111~~ n° 1 ⇨ ~~111~~ n° 020812
B375 ~~111~~ n° 1 ⇨ ~~111~~ n° 000407
B37E ~~111~~ n° 1 ⇨ ~~111~~ n° 000613

(b) / B373 ~~111~~ n° 020813 ⇨ ~~111~~ n° ...
B375 ~~111~~ n° 000408 ⇨ ~~111~~ n° ...
B37G ~~111~~ n° 1 ⇨ ~~111~~ n° ...

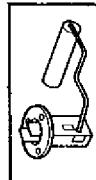

83.10
C.R.1037

- 1 - 77 00 756 739 (a)†
- 77 00 765 937 (b)†
- 77 02 082 736 (b)
- 2 - 77 00 684 089
- 3 - 77 00 684 090
- 4 - 77 00 688 983
- 77 02 082 737
- 5 - 77 00 760 828 (c)
- 6 - 77 00 771 149 (c)
- 7 - 77 01 986 998 (c)
- 8 - 77 00 724 671 (c)



83.10
C.R.1037

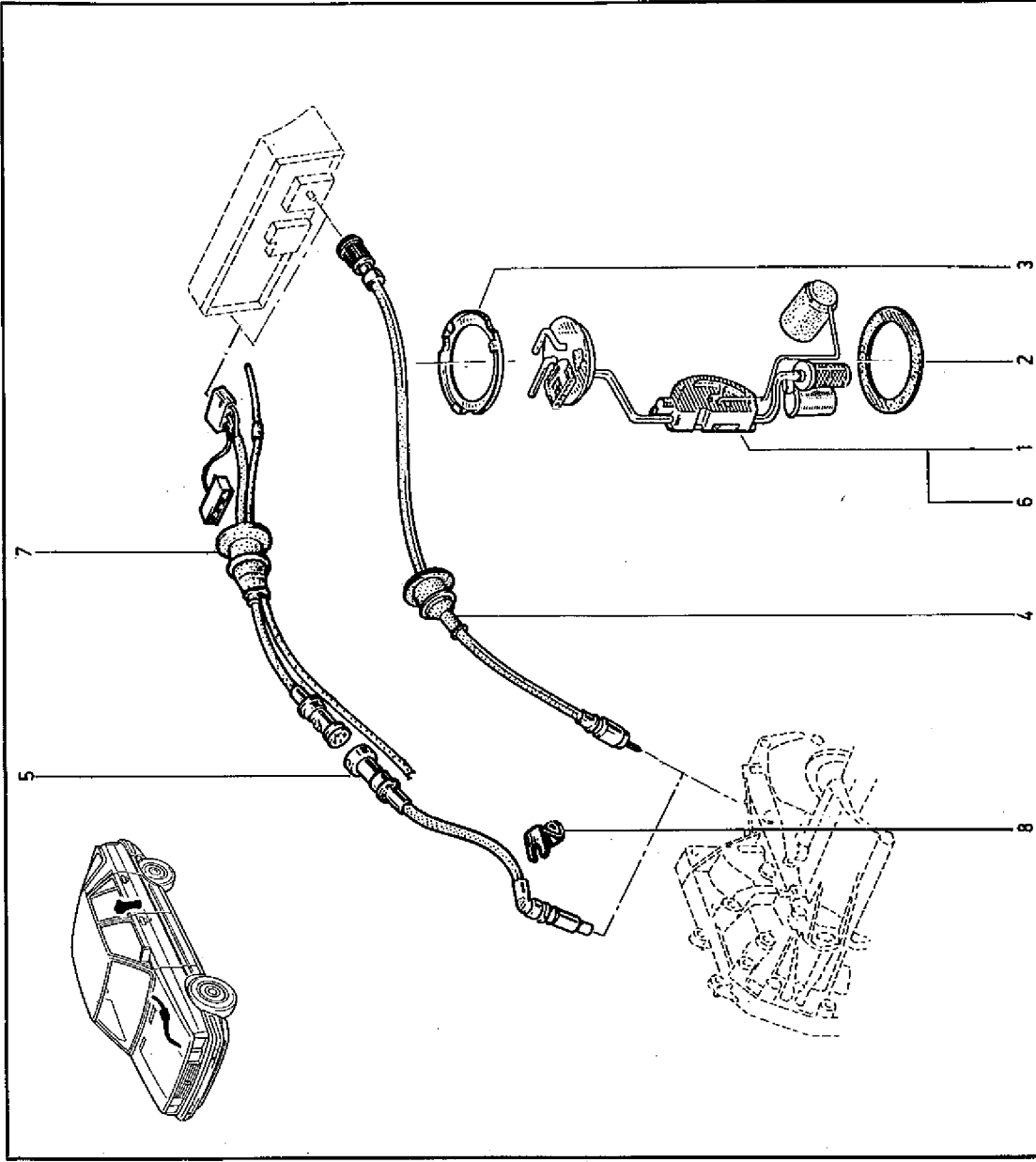

		(c) B375	
(a)	B372	□	n° 02572
	B373	□	n° 05325
(b)	B372	□	n° 02573
	B373	□	n° 05326

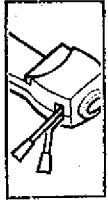

84.01

C.R.1037

- 1 - 77 01 349 318 +
- 77 00 690 473
- 2 - 77 02 081 786
- 77 01 349 319 +
- 77 00 690 474 (B-375)
- 3 - 77 03 016 022
- 4 - 79 03 056 005
- 5 - 77 03 046 069
- 6 - 77 01 349 472
- 77 00 760 825 (a),
- 77 02 082 701 (b)
- 7 - 77 03 008 027 +
- 77 03 008 056
- 8 - 77 01 349 417
- 9 - 77 03 016 321

84.01

C.R.1037

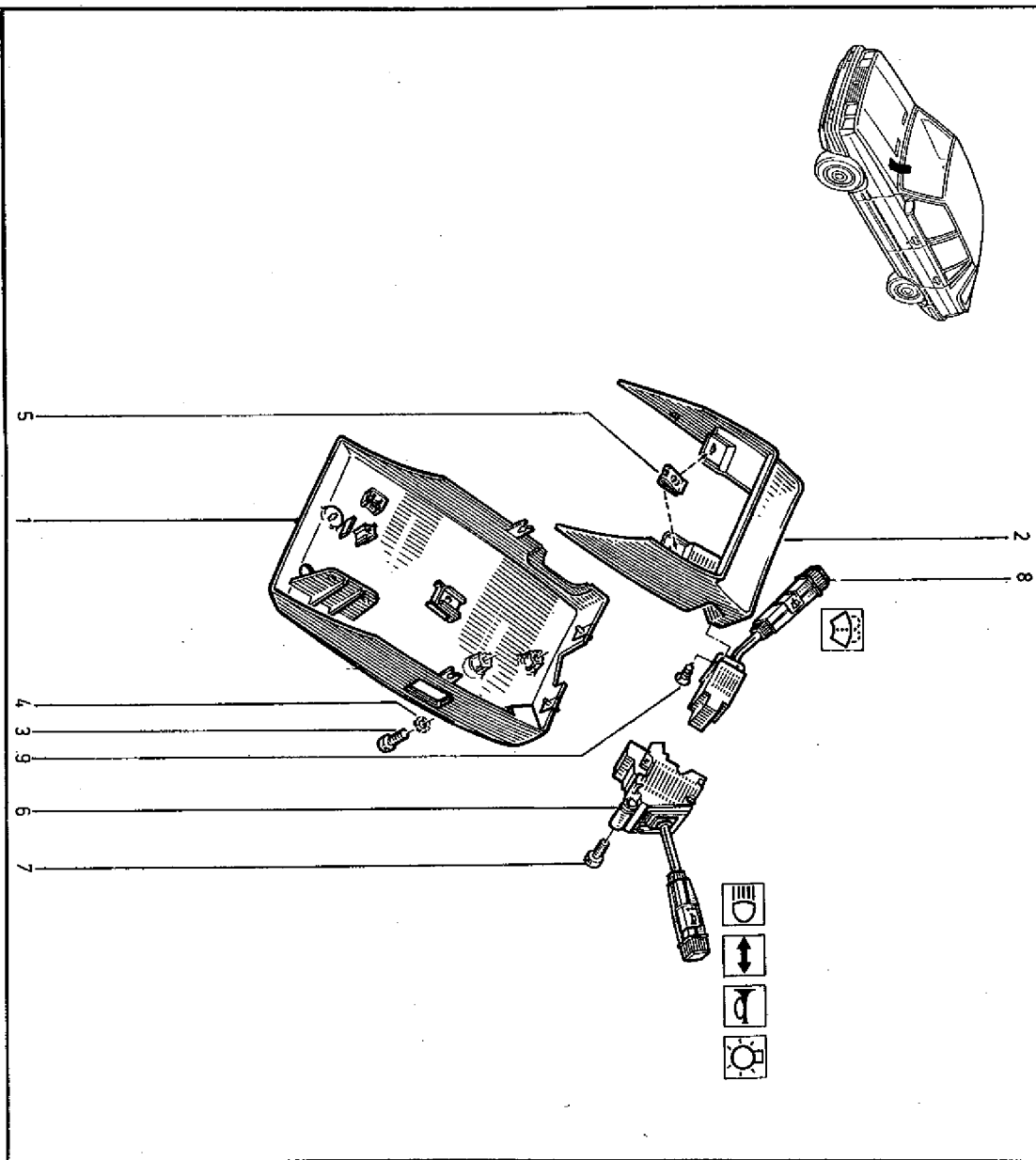
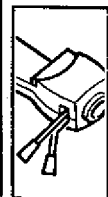

B376	→	n°	1	→	n°008136
B-371	→	n°	1	→	n°000708
B-373	→	n°	1	→	n°031962
B-375	→	n°	1	→	n°000773

B376	→	n°	008137	→	n°
B371	→	n°	000709	→	n°
B-373	→	n°	031963	→	n°
B-375	→	n°	000774	→	n°

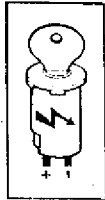

84.10
C.R.1037

- 1 - 77 00 752 565
- 2 - 77 02 073 688
- 3 - 77 02 073 024
- 4 - 77 03 004 090
- 5 - 77 01 349 278†
- 77 00 690 475

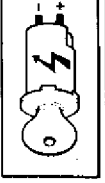

84.10
C.R.1037

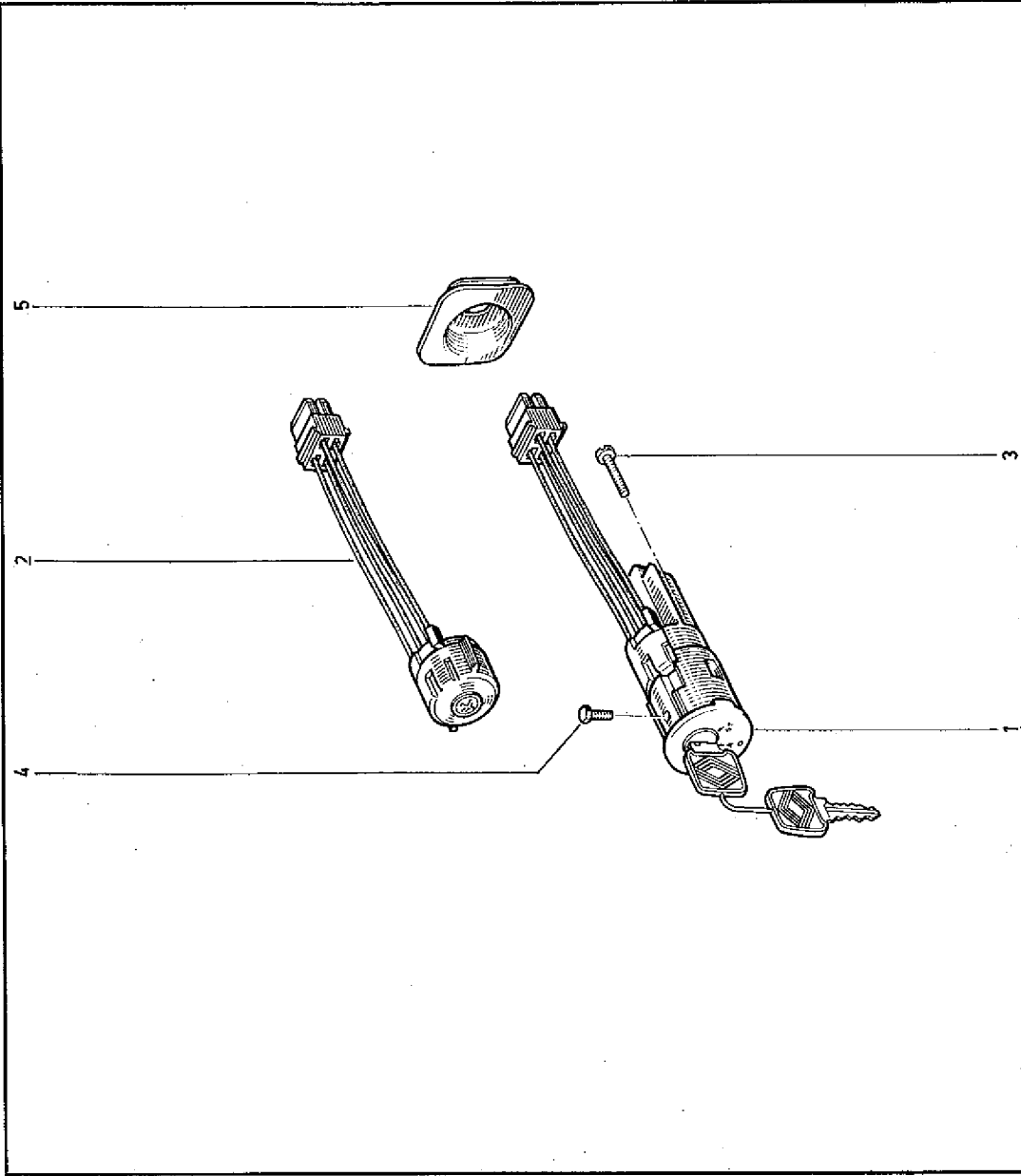

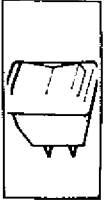

84.20
C.R.1037

- 1 - 77 01 349 370 +
- 77 00 765 726
- 2 - 77 01 349 369 +
- 77 00 765 728
- 3 - 77 00 752 121
- 4 - 77 01 349 623
- 5 - 77 00 695 744
- 6 - 77 00 728 024
- 7 - 77 00 678 762 (a)
- 8 - 77 00 686 719
- 9 - 77 00 690 636 (b)
- 10 - 77 01 349 408 (a) (b)
- 11 - 77 00 551 538

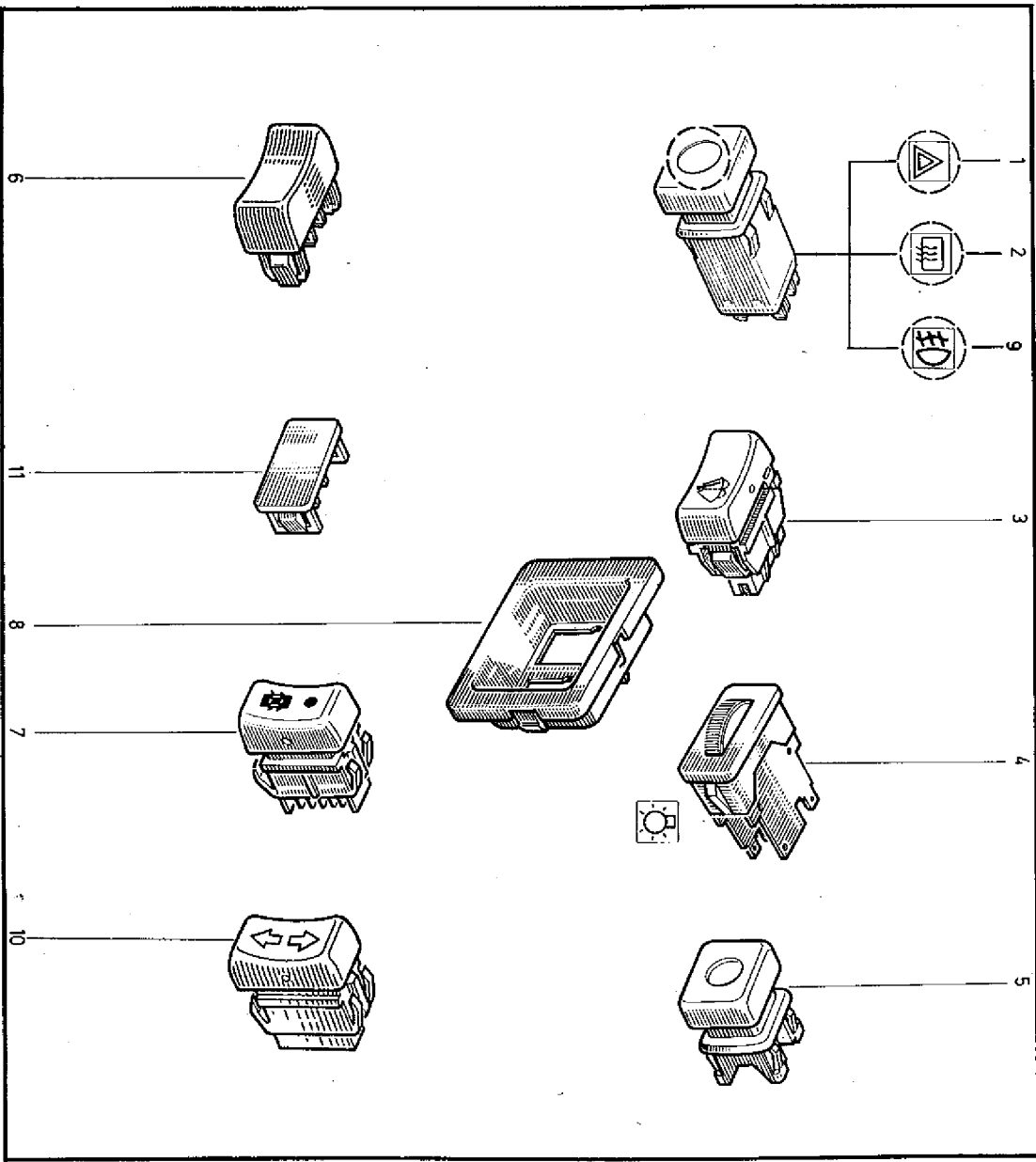

84.20
C.R.1037

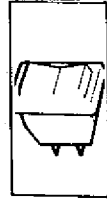

(a) B373
(b) B375



84.30
C.R.1037

- 1 - 77 02 082 508
- 2 - 77 02 073 455
- 3 - 77 02 073 456
- 4 - 77 00 758 287 +
77 00 765 844
- 5 - 77 00 676 012
- 6 - 77 01 349 047 (a)
- 7 - 77 02 089 420
- 8 - 77 00 756 046

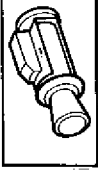

84.30
C.R.1037

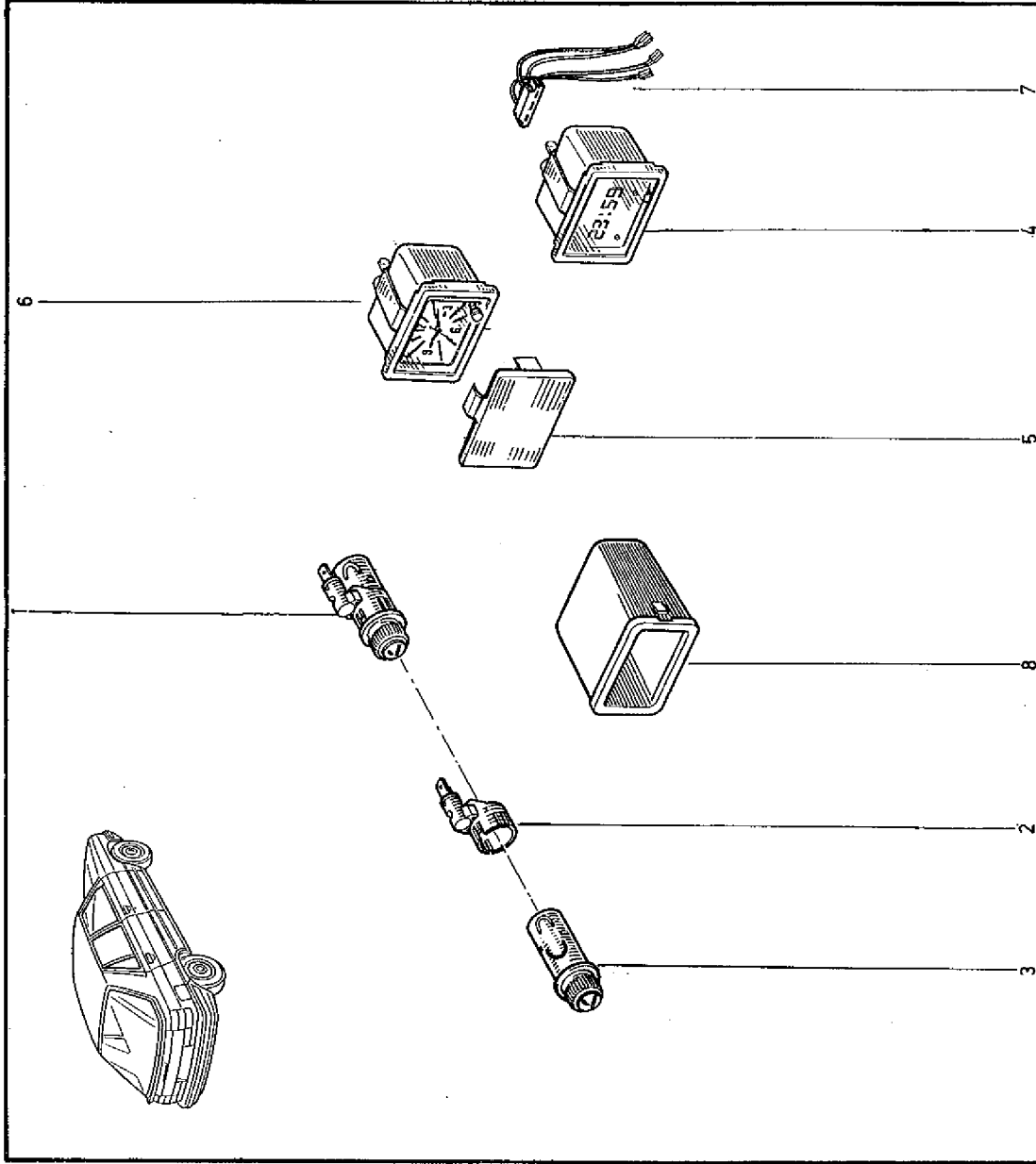

(a) B37G



85.03
Q.R.I.037

- 1 - 77 01 027 090
- 77 02 089 216
- 2 - 77 01 027 088
- 77 02 089 212
- 3 - 77 01 027 089
- 77 02 089 213
- 4 - 77 01 201 025
- 77 02 073 243
- 5 - 77 03 001 120 +
- 77 03 001 865
- 6 - 77 01 201 662
- 77 02 089 215
- 7 - 77 00 624 458
- 8 - 77 03 032 083
- 9 - 77 00 616 085
- 10 - 77 02 082 546
- 77 02 206 149
- 11 - 77 02 072 268 (L = 400)
- 12 - 79 03 032 010
- 13 - 77 00 637 825
- 14 - 77 03 046 048
- 15 - 77 02 089 315 (a)
- 16 - 77 02 082 649
- 17 - 77 02 082 565 (L = 451)

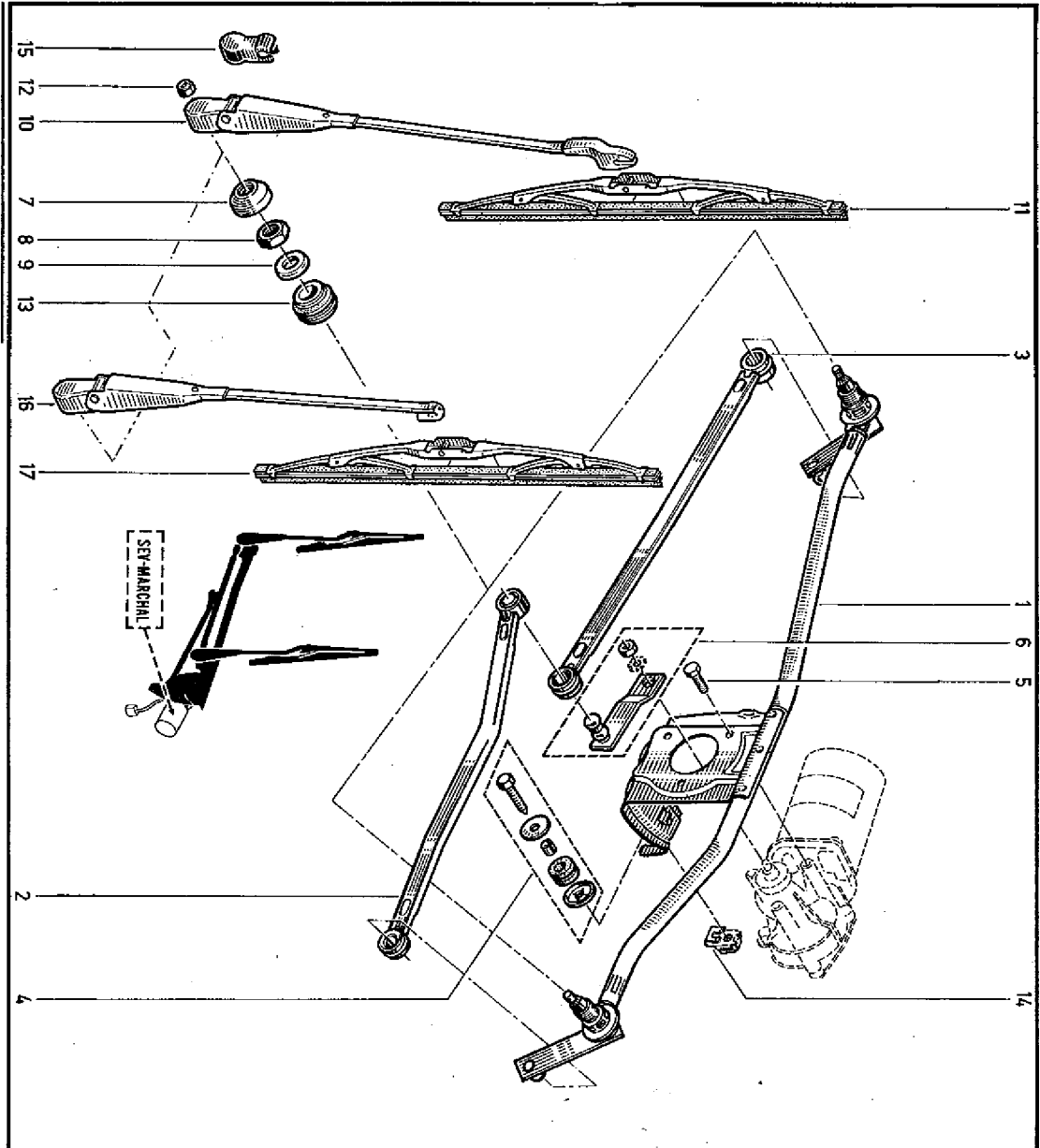

85.03
Q.R.I.037



B375	no	no	no	no
B373	no	no	no	no
B372	no	no	no	no
B376	no	no	no	no
B37E	no	no	no	no

(a)



85.06
C.R.1037



85.06
C.R.1037

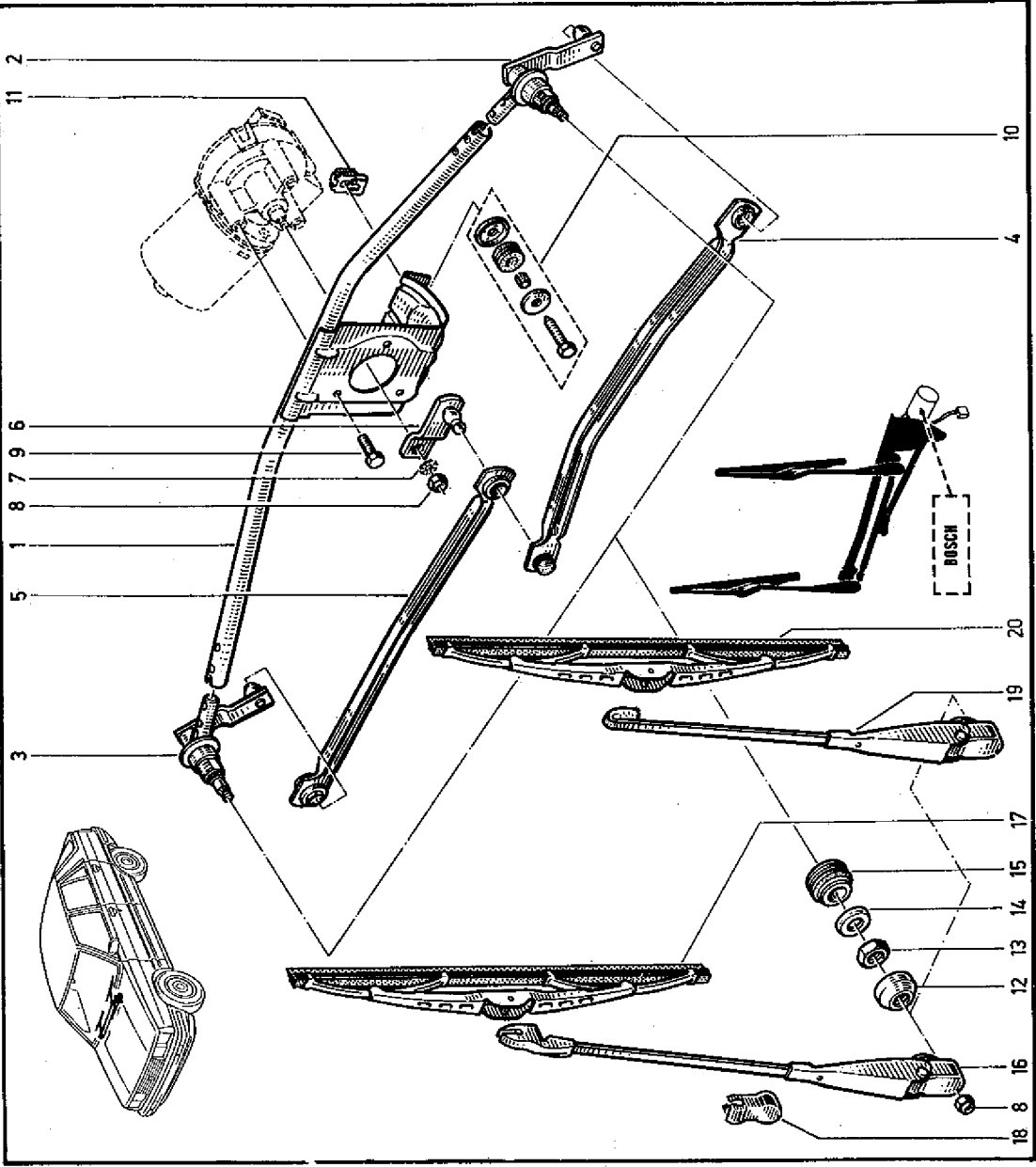

- 1 - 77 01 027 962
- 2 - 77 01 027 968
- 3 - 77 01 027 969
- 4 - 77 01 027 963
- 5 - 77 01 027 964
- 6 - 77 01 027 967
- 7 - 79 03 056 008
- 8 - 79 03 032 010
- 9 - 77 03 001 865
- 10 - 77 01 201 025
- 11 - 77 03 046 034
- 12 - 77 00 624 458
- 13 - 77 03 032 083
- 14 - 77 00 616 085
- 15 - 77 00 637 825
- 16 - 77 02 082 546
- 17 - 77 02 072 268 (L = 400)
- 18 - 77 02 089 315 (a)
- 19 - 77 02 082 649 (a)
- 20 - 77 02 082 565 (L = 451)

(a) B375

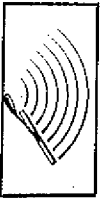

85.10
C.R.1037

- 1 - 77 01 028 239
- 2 - 77 01 201 628
- 3 - 77 01 026 736
- 4 - 77 01 201 636
- 5 - 77 01 026 789
- 6 - 77 01 026 803
- 7 - 77 01 027 196

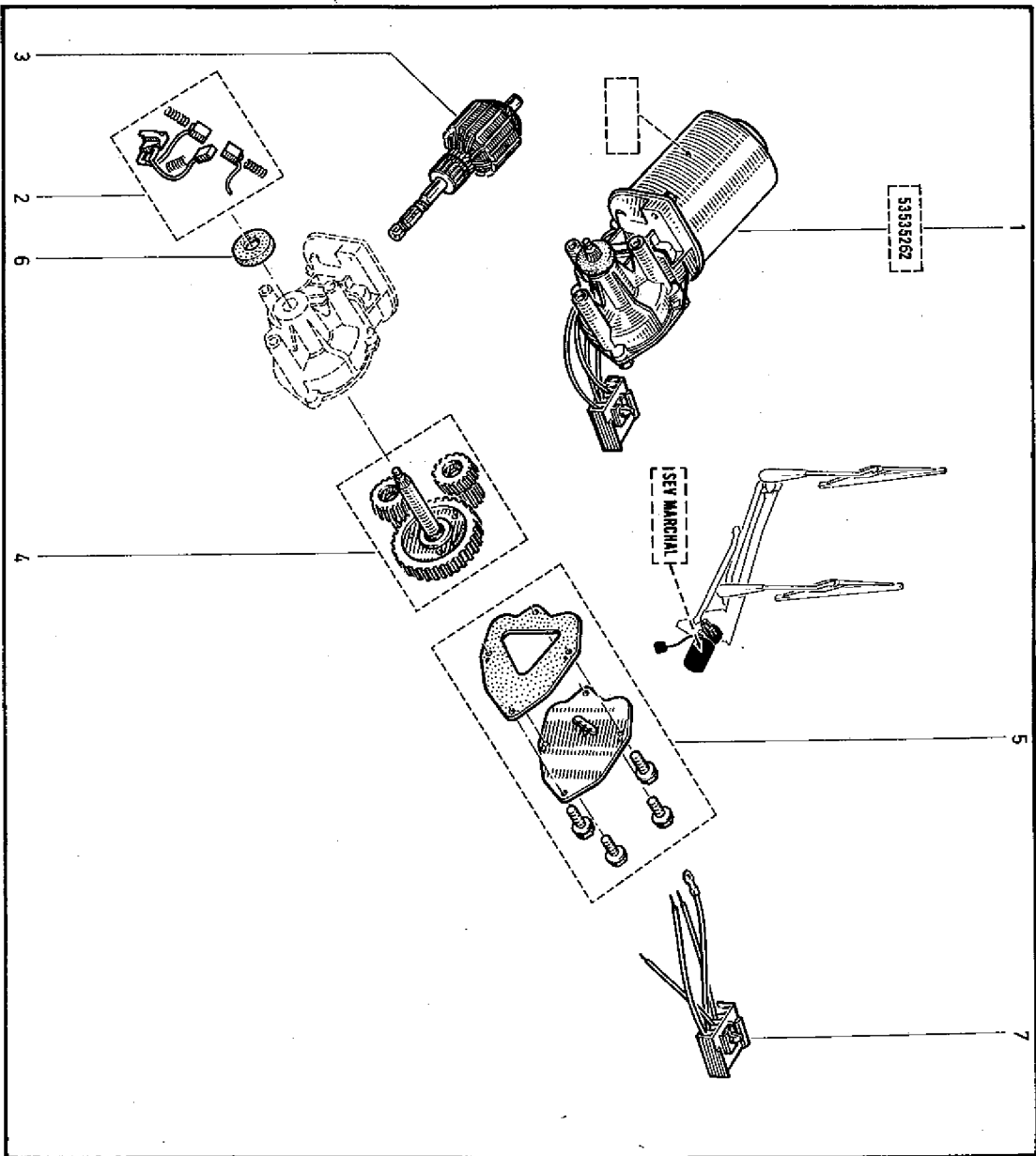

85.10
C.R.1037





85.12
C.R.1037

- 1 - 77 02 089 214
- 2 - 77 02 073 236
- 3 - 77 02 073 237
- 4 - 77 02 073 235
- 5 - 77 02 073 272



85.12
C.R.1037

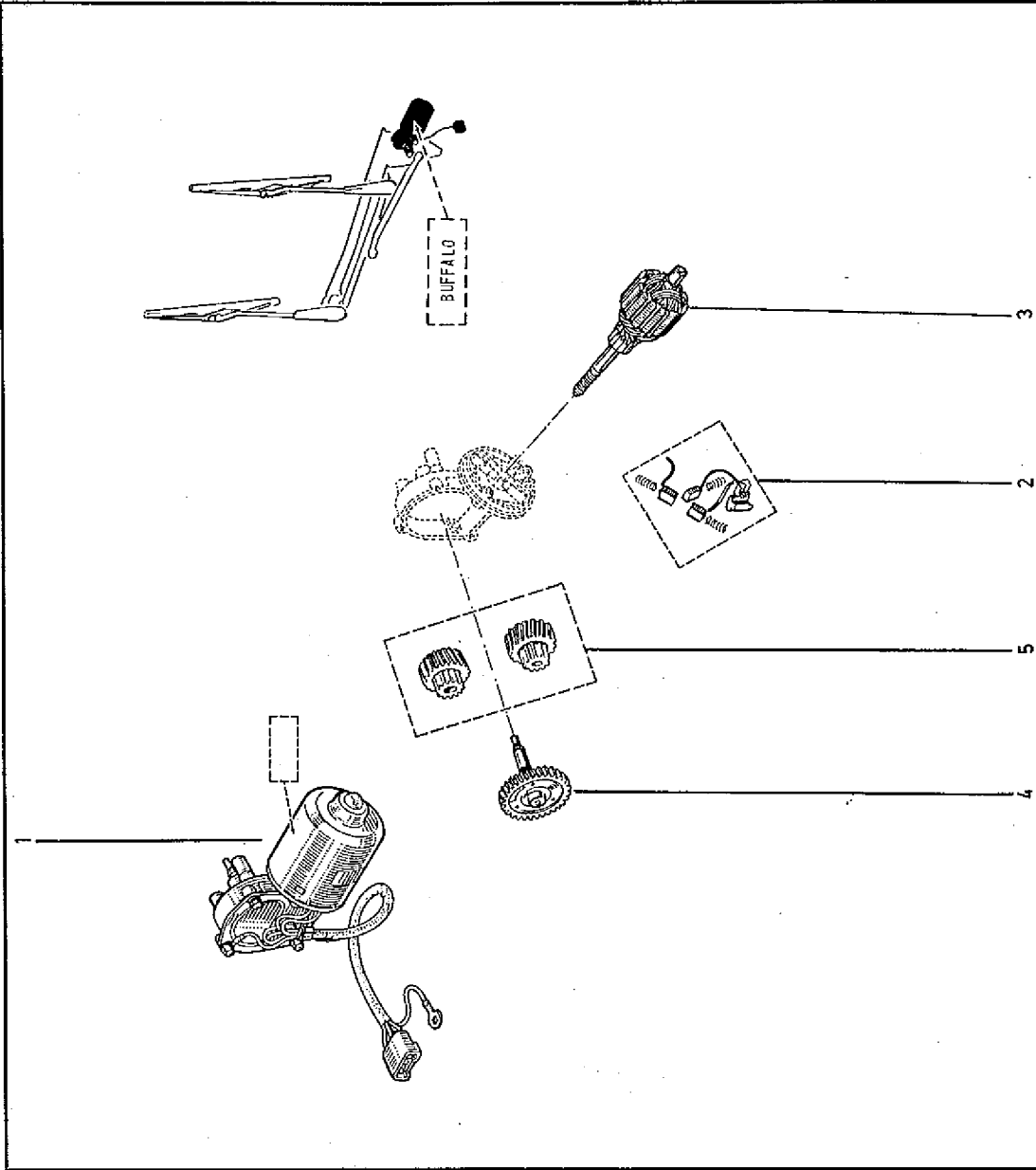



85.15
C.R.1037

- 1 - 77 01 028 238
- 2 - 77 01 027 960
- 3 - 77 01 027 961
- 4 - 77 01 018 211
- 5 - 77 01 201 751
- 6 - 77 03 007 039
- 7 - 77 01 021 589
- 8 - 77 01 013 646

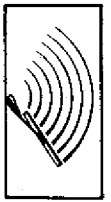
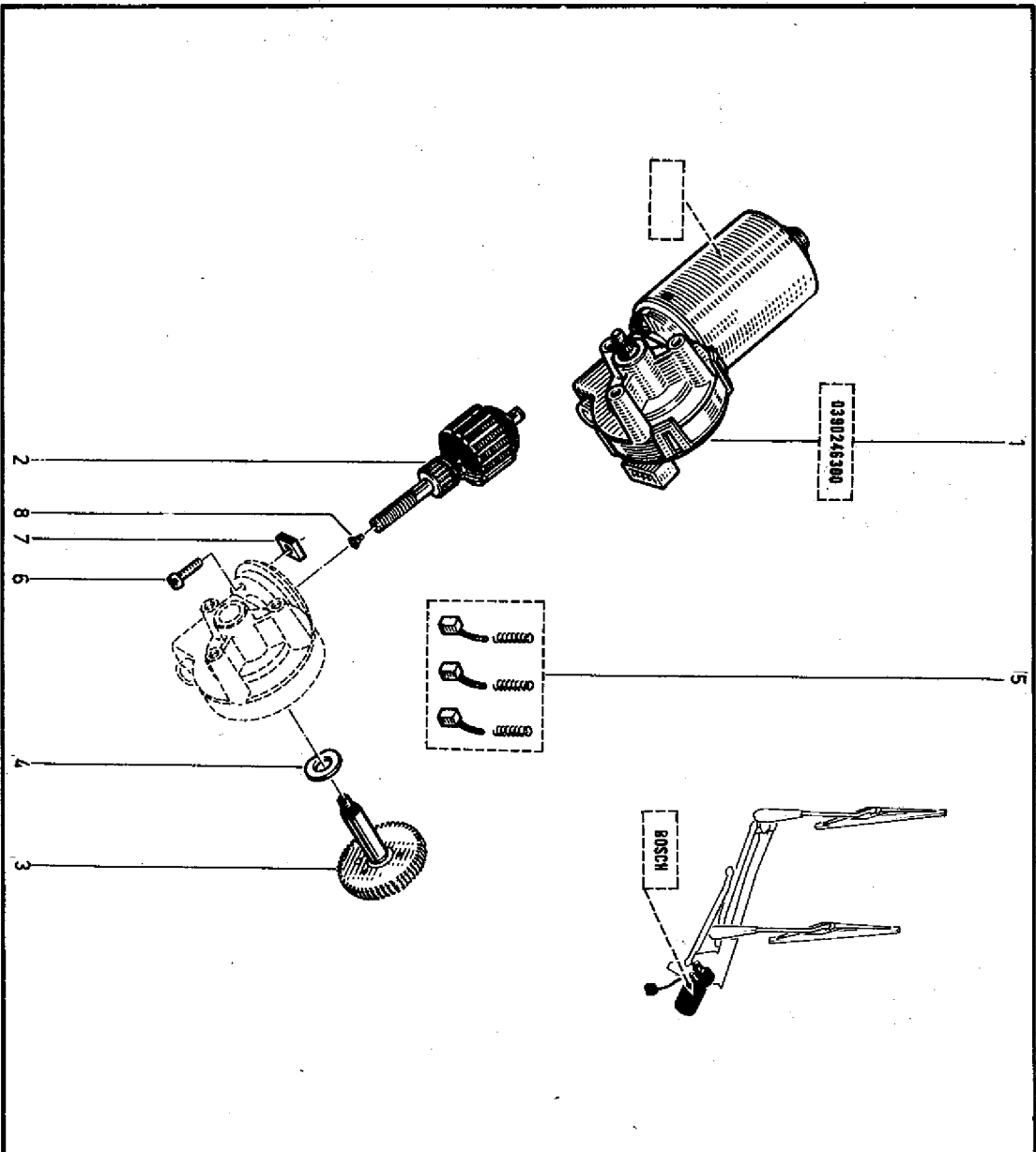

85.15
C.R.1037



85.18
C.R. 1037

- 1 - 77 01 596 824
- 2 - 77 00 615 808
- 3 - 77 00 751 335
- 4 - 77 03 032 083
- 5 - 77 00 753 009
- 6 - 77 02 082 564
- 7 - 79 03 032 018
- 8 - 77 02 082 565
- 9 - 77 00 710 022

B373



85.18
C.R. 1037

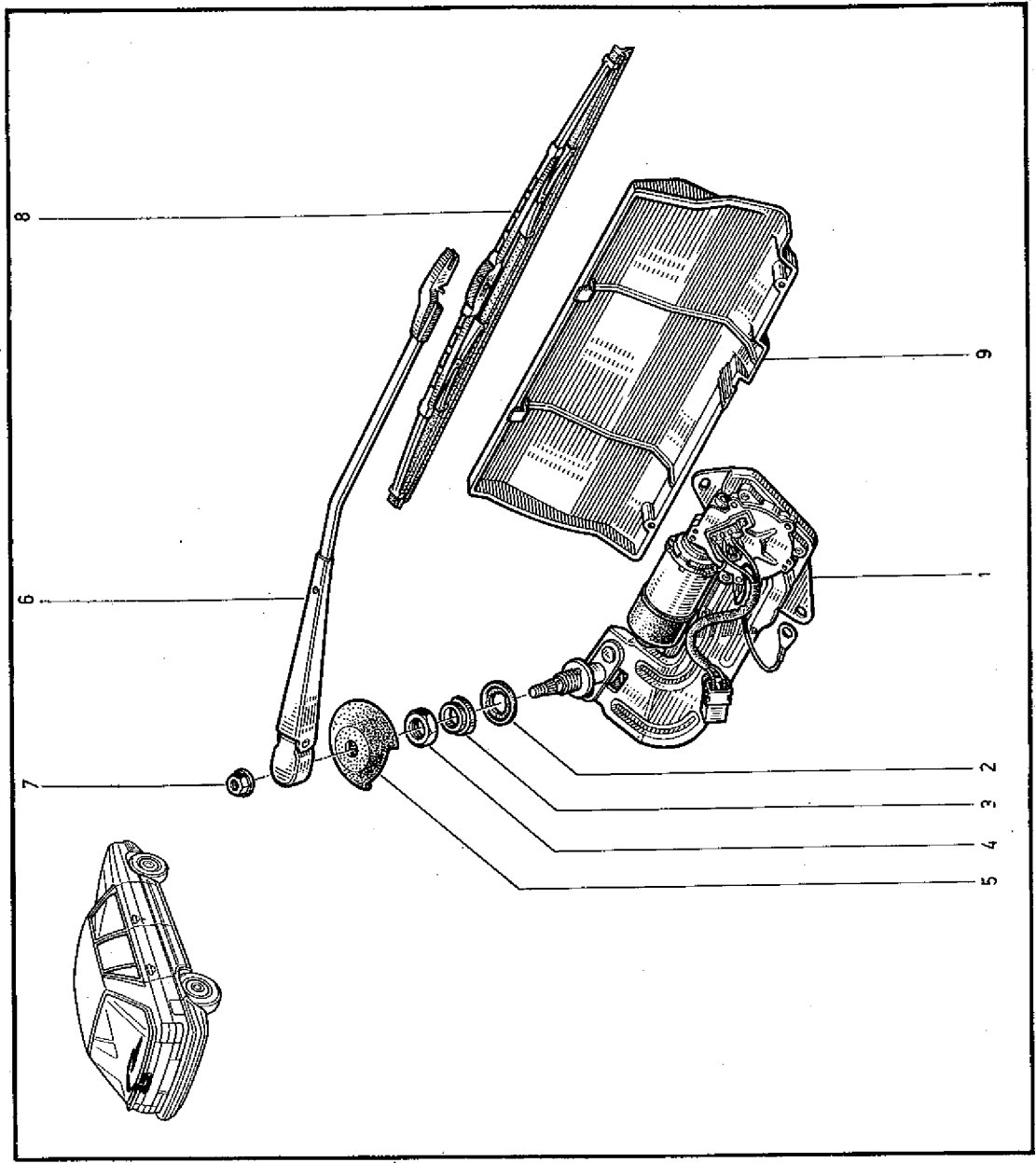



86.01
C.R.1037

- 1 - 77 04 002 236 +
- 77 02 082 529
- 2 - 77 04 000 065
- 3 - 77 04 002 215
- 4 - 77 00 690 300 +
- 77 05 002 060
- 5 - 77 02 082 552
- 6 - 77 04 000 008
- 7 - 77 04 000 014 (a)
- 77 00 759 740 (b)
- 8 - 77 00 759 741 (b)
- 9 - 77 00 515 140

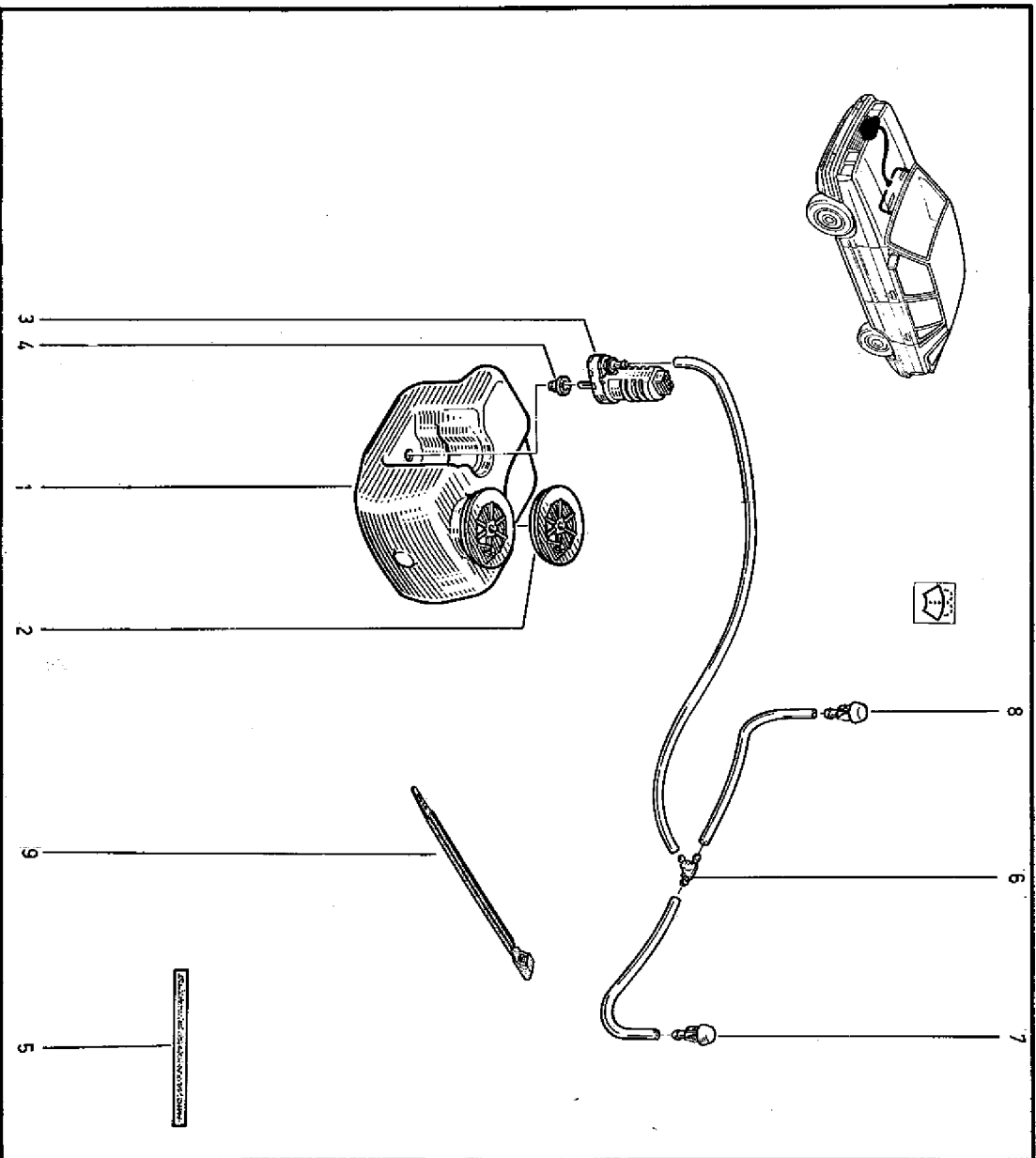

86.01
C.R.1037



(a)	B372	1	1	1	n°1111
	B373	1	1	1	n°1652
(b)	B372	1	1	1	n°1112
	B373	1	1	1	n°1653



86.20
C.R.1037

- 1 - 77 01 348 718 †
- 77 00 732 507
- 77 01 348 716 †
- 77 00 732 506
- 77 02 082 676
- 2 - 77 01 348 194
- 77 00 759 441
- 3 - 00 10 545 600
- 4 - 77 01 349 273 †
- 77 02 072 708
- 77 00 732 503
- 5 - 77 01 348 190 †
- 77 02 072 100
- 6 - 77 03 080 036
- 7 - 77 03 001 658
- 8 - 77 03 033 005



86.20
C.R.1037

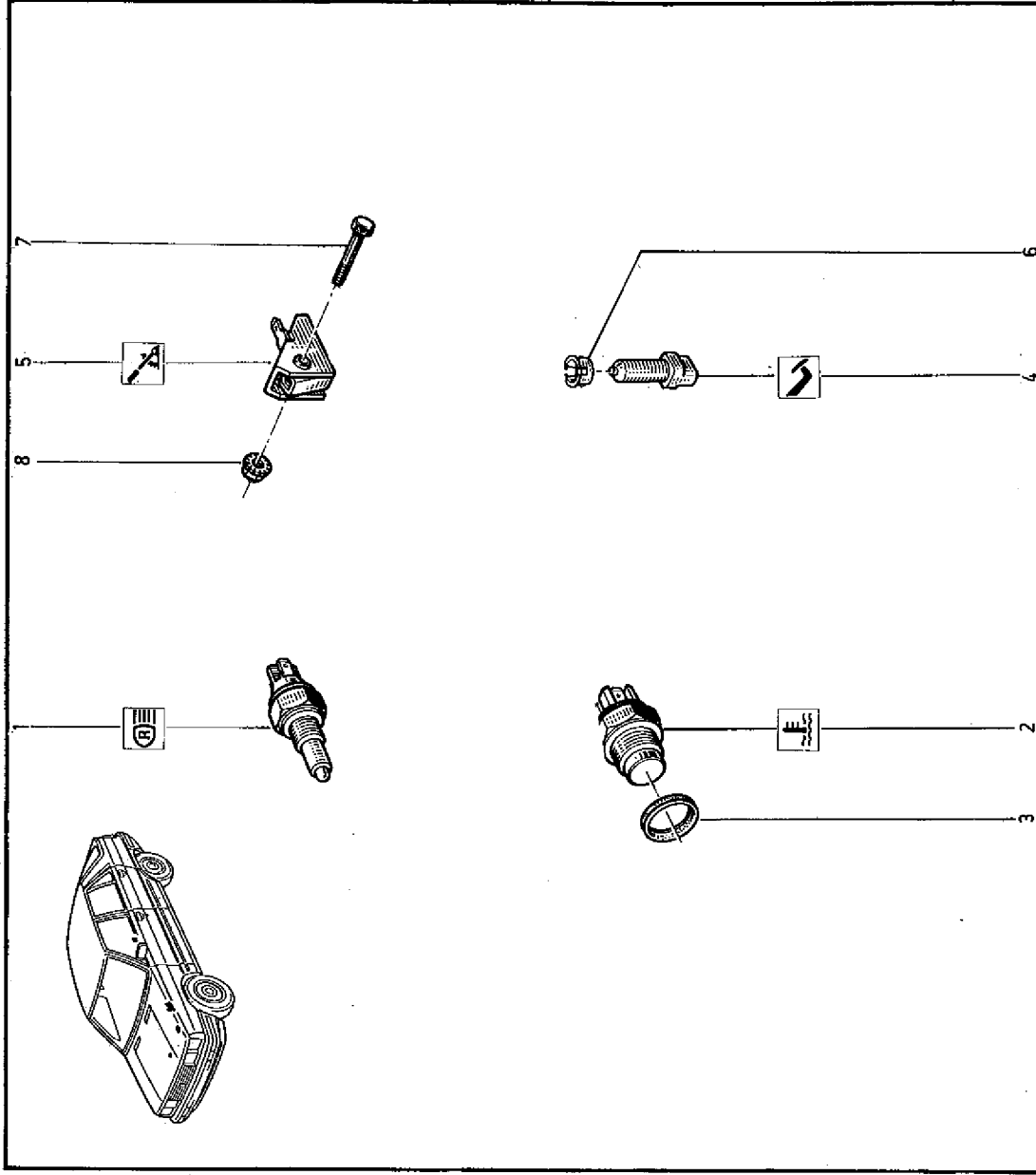



86.30
C.R.1037

- 1 - 77 02 061 773 (C1)
- 77 02 072 956 (C5)
- 2 - 10 81 350 582
- 3 - 77 02 061 760
- 4 - 77 01 348 860
- 5 - 77 02 072 110
- 6 - 77 02 061 771 (C1)
- 77 02 072 958 (C5)
- 7 - 77 00 718 575
- 77 02 089 697
- 8 - 77 03 016 024
- 9 - 77 02 071 811
- 10 - 77 02 072 095
- 77 02 072 746
- 11 - 79 03 092 006
- 12 - 77 02 073 767
- 13 - 79 03 056 003
- 14 - 77 02 082 673 (B-375)
- 15 - 77 04 000 461
- 16 - 08 53 523 300

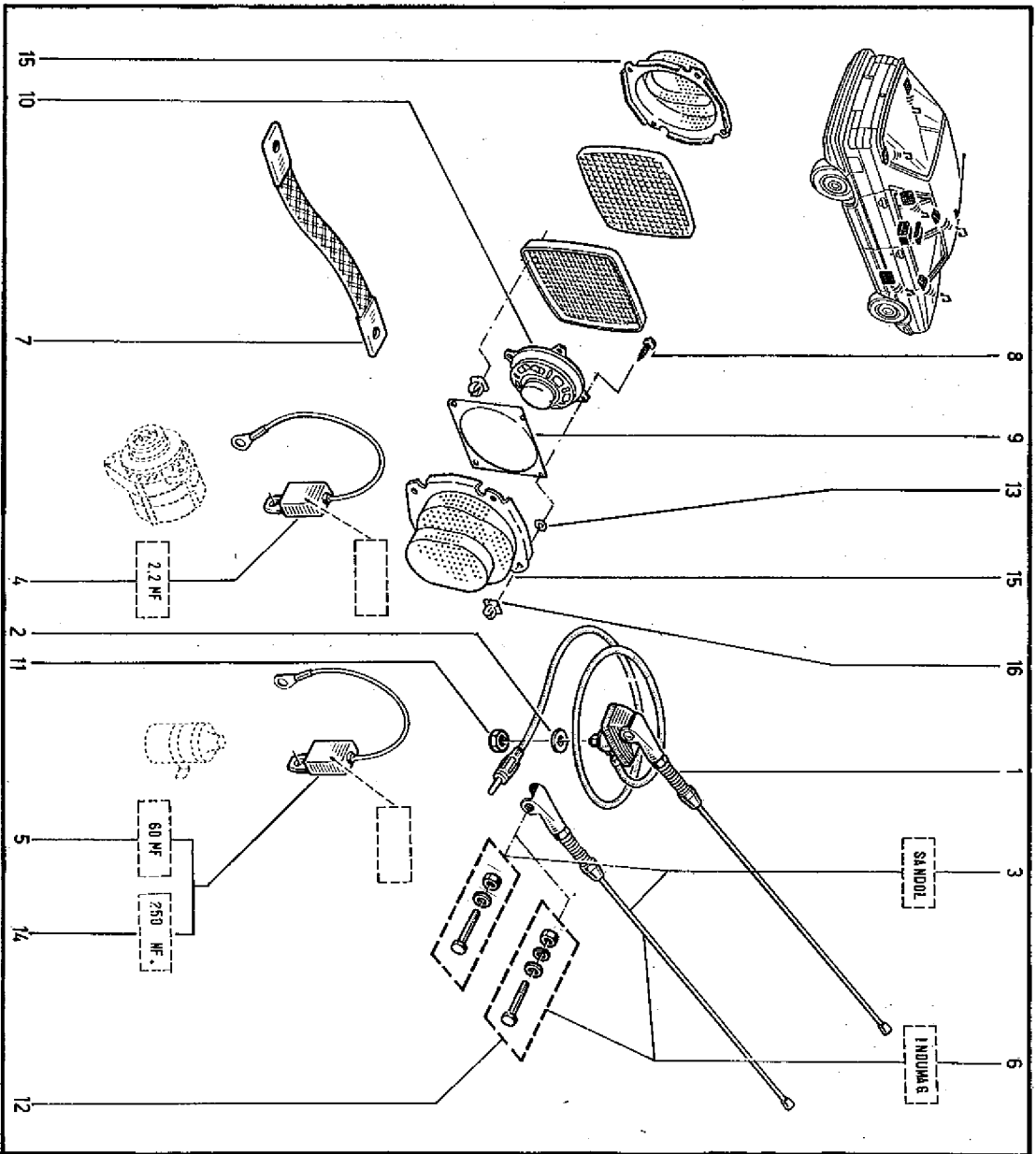

86.30
C.R.1037





87.30
C.R.1037

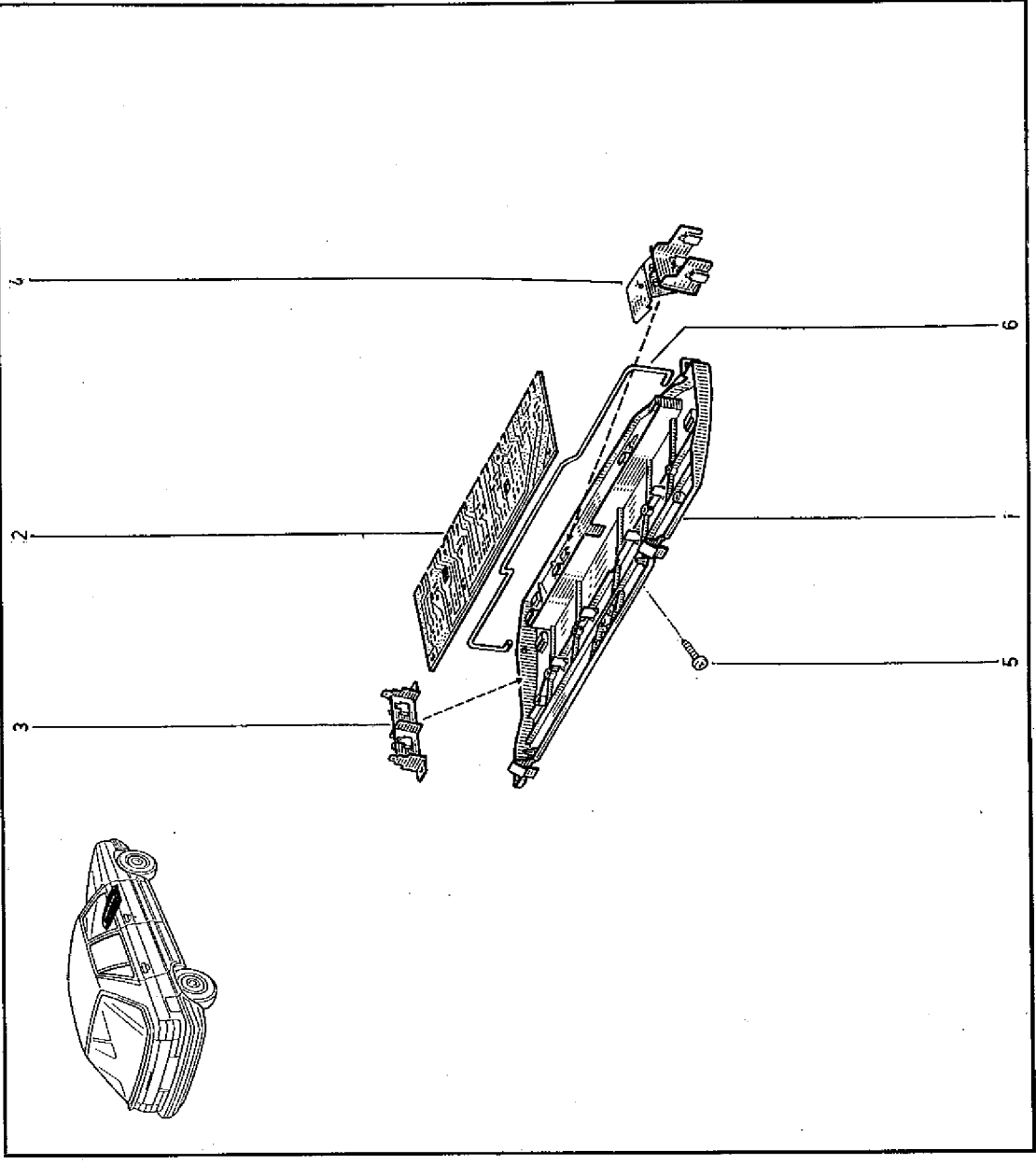

87.30
C.R.1037

- 1 - 77 04 001 769
- 2 - 77 01 988 045
- 3 - 77 00 709 375
- 4 - 77 00 754 260
- 5 - 77 03 016 017
- 6 - 77 00 756 113

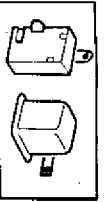

87.40
C.R.1037

- 1 - 77 00 638 976 +
77 02 072 906
- 77 02 072 031 +
- 77 02 072 932
- 2 - 77 02 072 090
77 02 072 895
- 3 - 77 01 349 624 +
77 02 072 451
77 02 072 852
77 02 072 855
- 4 - 77 00 754 504 (a)
5 - 77 02 072 090
- 6 - 77 00 753 401 (a) +
77 00 768 551
77 02 082 647
77 02 082 724
- 7 - 60 01 006 410
- 8 - 77 00 755 267
77 02 082 573
- 9 - 77 00 756 205
- 10 - 79 03 053 020
- 11 - 77 03 016 291
- 12 - 77 02 072 115
77 00 767 620 (B = 375)
77 02 072 896
77 02 072 898
- 13 - 77 00 771 721 (B = 375)

(a) / B373

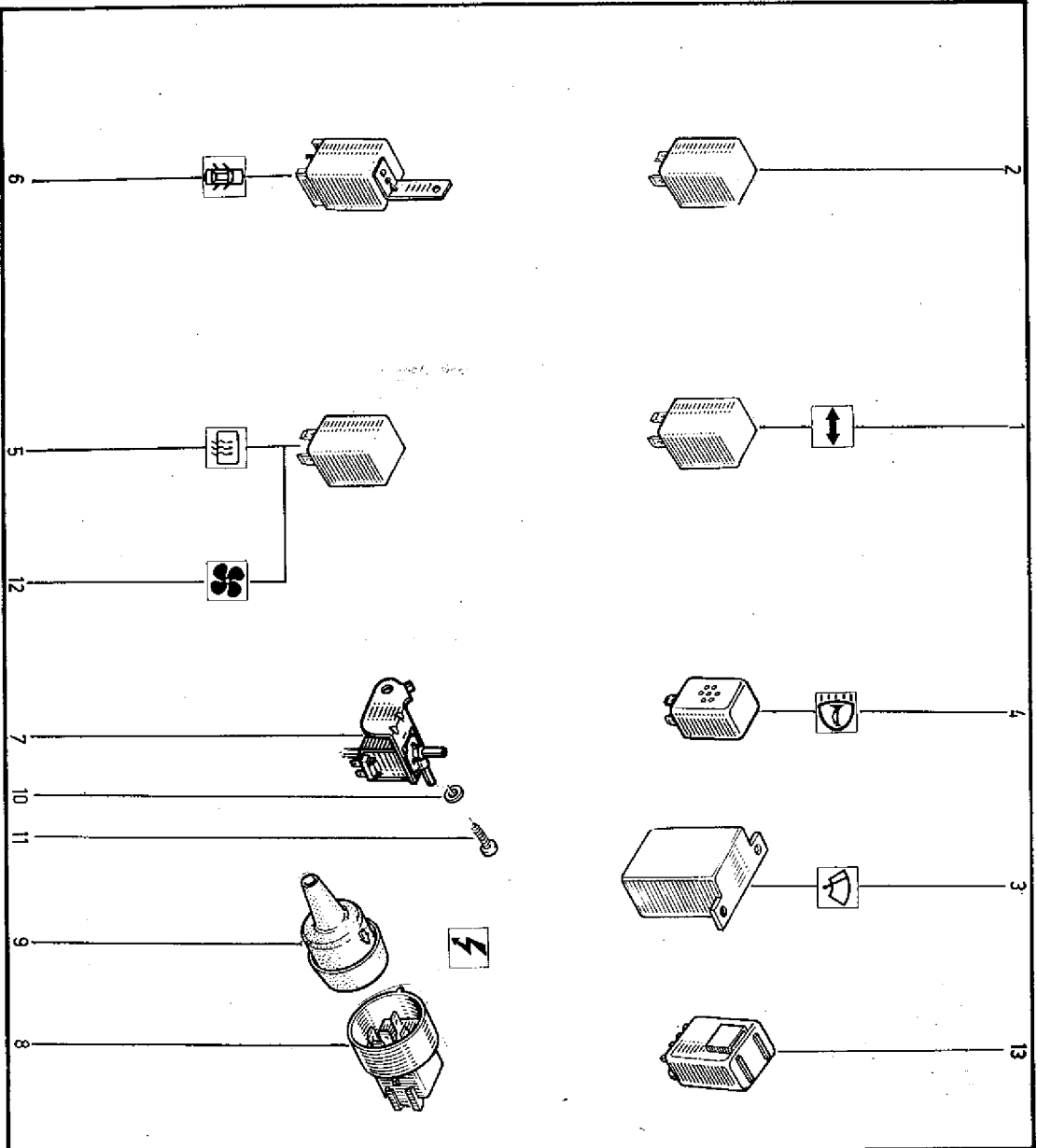

87.40
C.R.1037

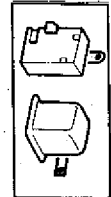



87.50
C.R.1037

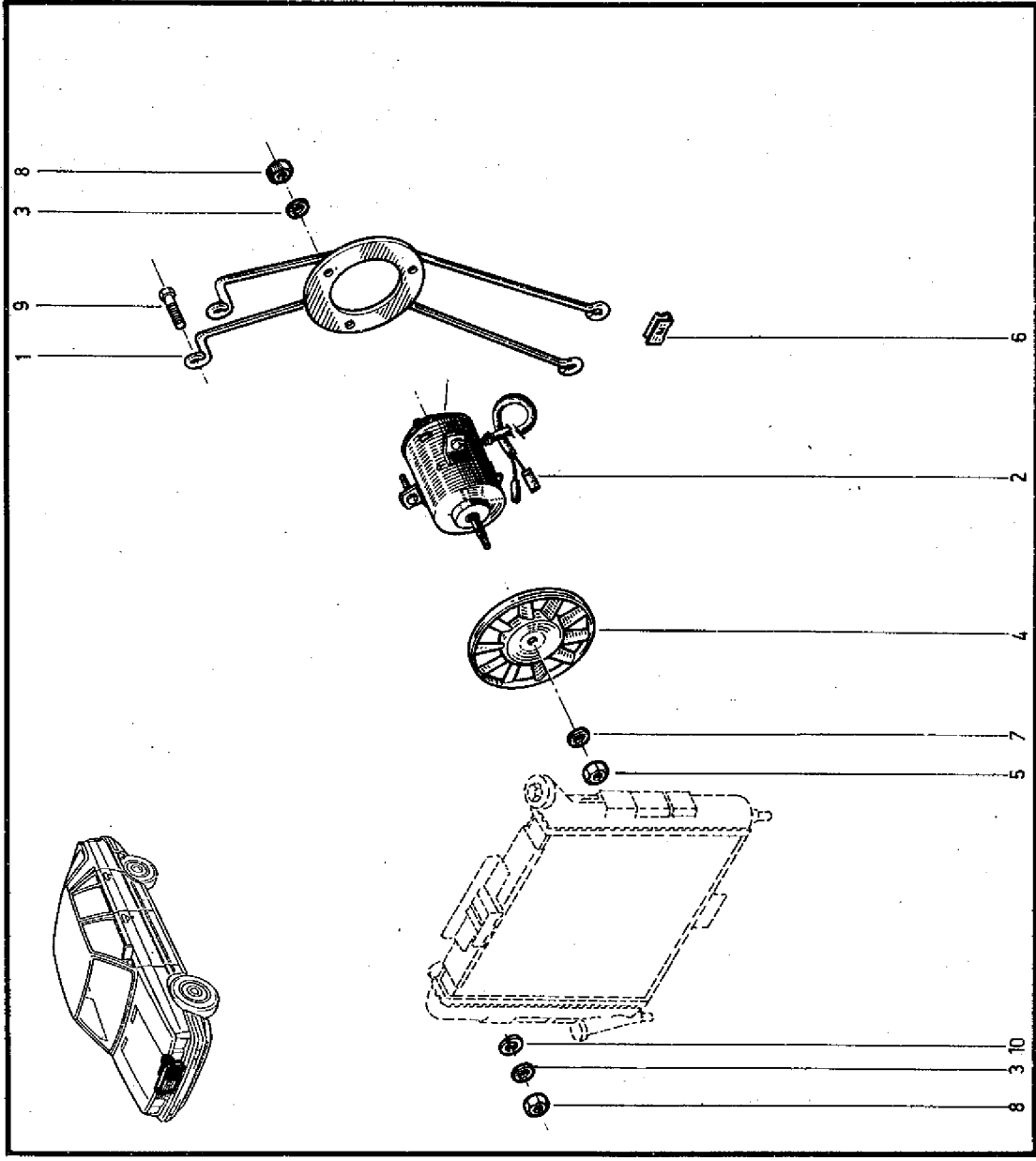

87.50
C.R.1037



- 1 - 77 02 082 575
- 2 - 77 02 061 984
- 3 - 77 03 055 007
- 4 - 77 02 082 576
- 5 - 79 03 032 072
- 6 - 77 03 076 131
- 7 - 77 03 055 011
- 8 - 79 03 032 009
- 9 - 77 03 001 122
- 10 - 79 03 053 033

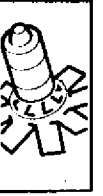

87.52
C.R.1037

- 1 - 77 00 700 301
- 77 02 082 630
- 2 - 77 01 349 413 (a)
- 77 00 758 428 (b)
- 77 02 072 530 (c) (A)
- 77 02 072 545 (c) (B)
- 3 - 77 00 635 419
- 4 - 77 03 032 084
- 5 - 79 03 053 028
- 6 - 77 03 055 007
- 7 - 79 03 032 010
- 8 - 77 03 072 044
- 9 - 77 03 076 146
- 10 - 77 03 053 032

↻ B373 B37E B37S

87.52
C.R.1037

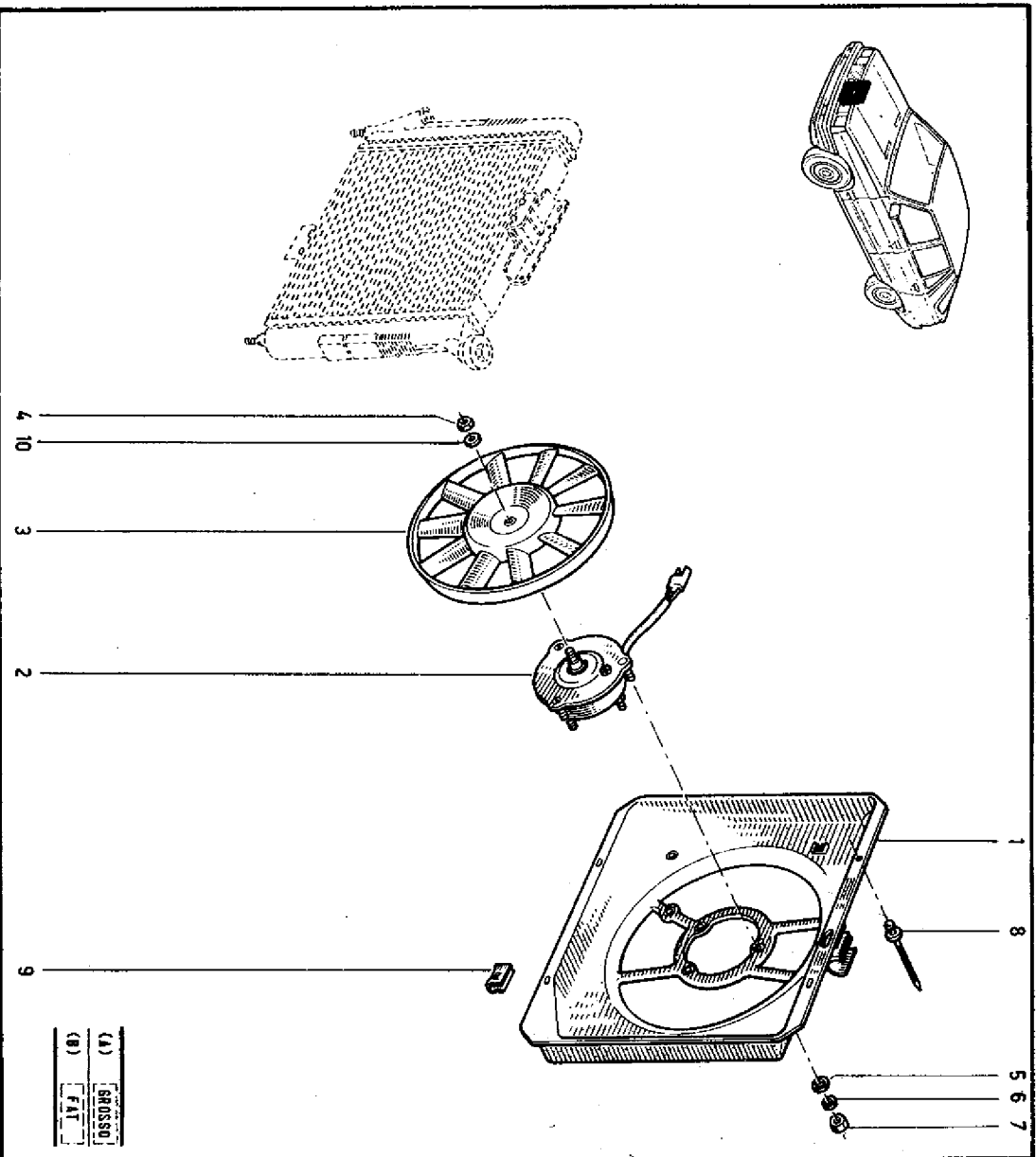

(A)	GRUSSO
(B)	FAT

- (a) / B373 n° 1 n° 001 364
- B373 n° 001 365 n° 025537
- (b) B37E n° 1 n° 002534
- B37S n° 1 n° 000631
- B373 n° 025538 n°
- B37E n° 002535 n°
- (c) B37S n° 000632 n°

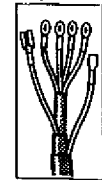

88.02
C.R.1037

- 1 - 77 01 985 977
- 2 - 77 01 986 406
- 3 - 77 02 082 596 Δ MI
- 4 - 77 02 082 640 Δ EI
- 5 - 77 01 986 813 +
- 6 - 77 02 082 629
- 7 - 77 02 082 578 (a) Δ MI
- 8 - 77 01 986 818 (b) Δ EI
- 9 - 77 01 986 268
- 10 - 77 01 986 768
- 11 - 77 02 082 584
- 12 - 77 01 986 781 (a) \odot
- 13 - 77 01 986 780 \square
- 14 - 77 02 082 582
- 15 - 77 01 986 806 \odot +
- 16 - 77 02 082 683 \odot
- 17 - 77 01 986 709 \square
- 18 - 77 02 082 583
- 19 - 77 02 082 580 +
- 20 - 77 02 073 794
- 21 - 77 02 082 581 +
- 22 - 77 02 073 795

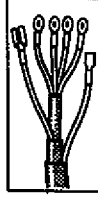

88.02
C.R.1037

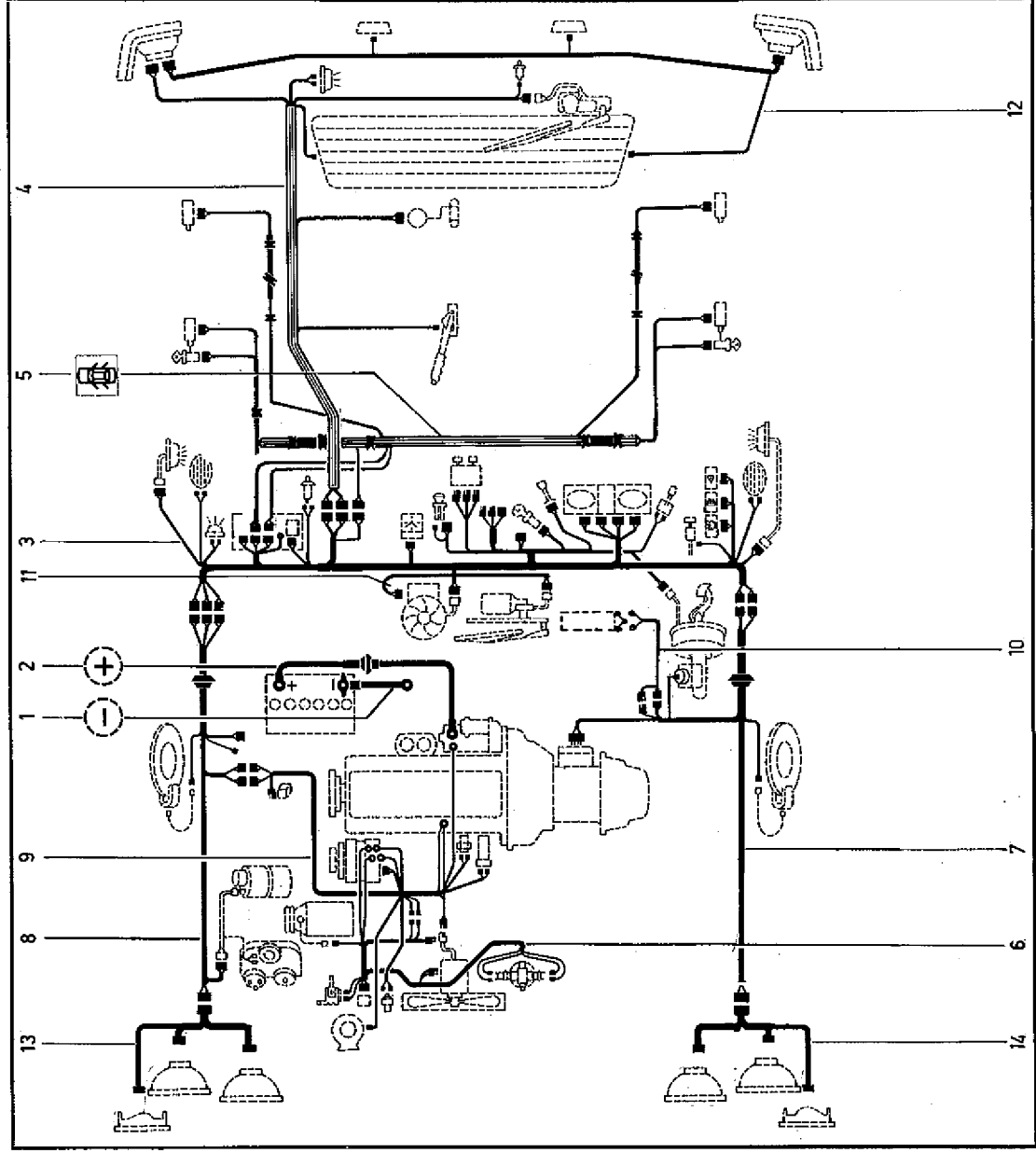

- (a) / B373
- (b) / B372 \square n° ... | \square \square \square n°MOD.86
- (c) / B373 \square n° ... | \square \square \square n°16883

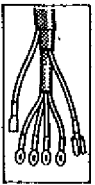

88.03

C.R.1037

- 1 - 77 01 986 977
- 2 - 77 01 986 406 +
- 77 02 082 761
- 3 - 77 02 082 709 (d)
- 77 02 082 760 (e)
- 4 - 77 02 082 730 (d)
- 77 02 082 700 (e)
- 5 - 77 01 986 818
- 6 - 77 01 986 268 +
- 77 02 082 768 +
- 7 - 77 02 082 725 (d)
- 77 02 072 762 (e)
- 8 - 77 02 082 710 (d)
- 77 02 082 763 (e)
- 9 - 77 02 082 711 (d) +
- 77 02 082 765 (e) +
- 77 02 082 712 (d) +
- 77 02 082 764 (e) +
- 10 - 77 02 082 582 (d) +
- 77 02 082 758 (e) +
- 11 - 77 02 082 683 +
- 77 01 986 709 +
- 12 - 77 02 082 583 (d) (b)
- 77 02 073 794
- 13 - 77 02 073 795
- 14 - 77 02 082 663 (a)
- 15 - 77 02 082 759 (c)
- 77 02 082 759 (c)

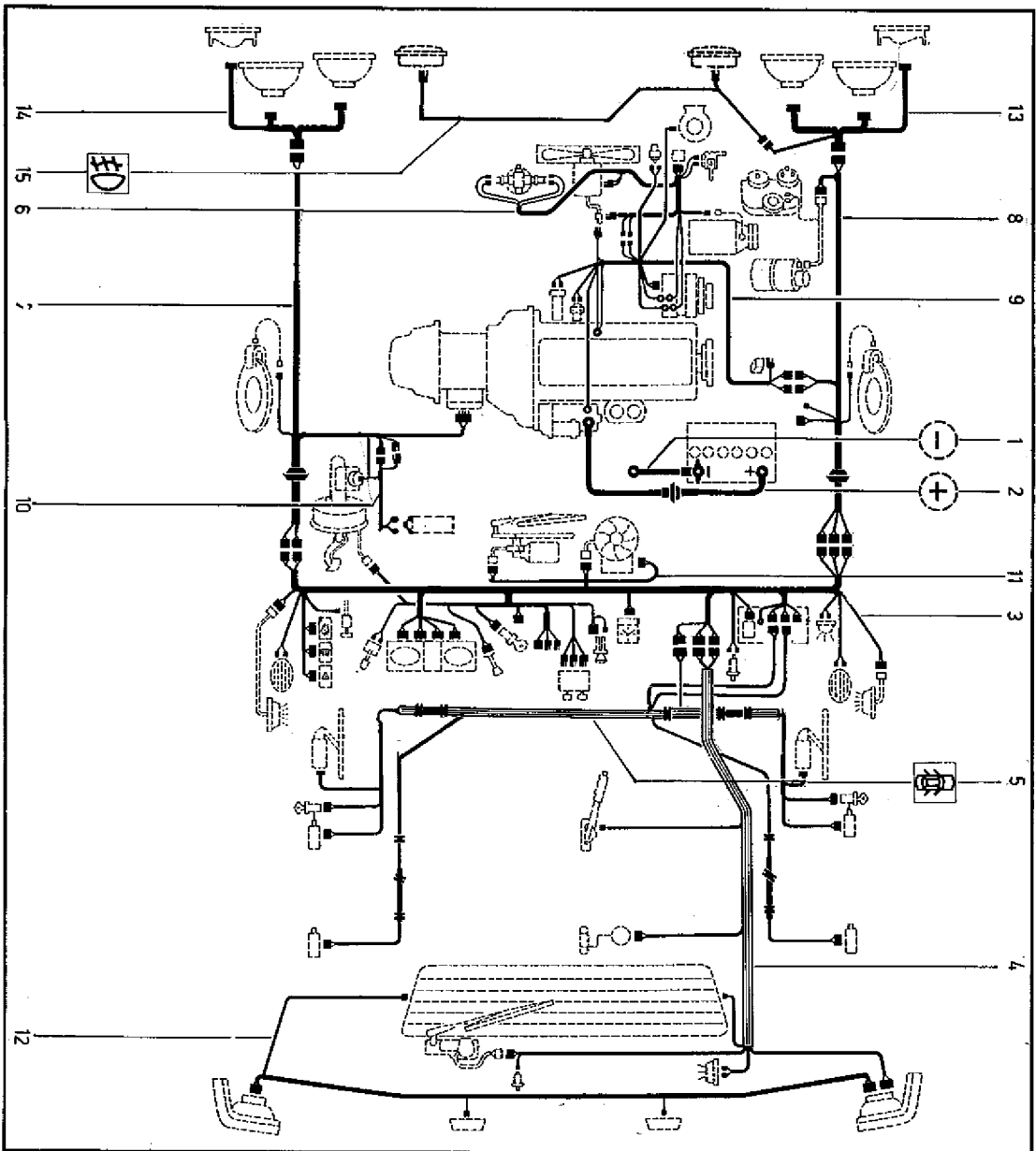

88.03

C.R.1037

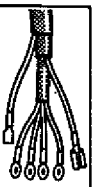

- B37G n° 1 ⇨ n°
- B37E n° 1 ⇨ n°
- B373 n° 016884 ⇨ n°
- (a) / B37E n° 1 ⇨ n° 000954
- (c) / B37E n° 000955 ⇨ n°
- (b) / B37G n° 1 ⇨ n° 001574

- (d) B37G n° 1 ⇨ n° 001708
- B37E n° 1 ⇨ n° 000913
- B373 n° 016884 ⇨ n° 020812
- B37G n° 001709 ⇨ n° 002243
- (e) B37E n° 000914 ⇨ n° 001353
- B373 n° 020813 ⇨ n° 022837

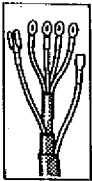

- 1 - 77 01 985 977
- 2 - 77 02 082 761
- 3 - 77 02 082 769
- 4 - 77 02 082 700 (e)
- 5 - 77 01 986 818
- 6 - 77 02 073 795
- 7 - 77 02 082 762
- 8 - 77 02 082 766
- 9 - 77 02 082 767 (g)
- 10 - 77 02 082 758
- 11 - 77 02 082 683 (f)
- 77 01 986 806 (c)(d)(A) (k)
- 77 01 986 709 (b)
- 12 - 77 02 082 759 (c)
- 13 - 77 02 073 794
- 14 - 77 02 082 768 (a) (f)

P001189

- (b) B37G
- (c) B37E
- (d) B373

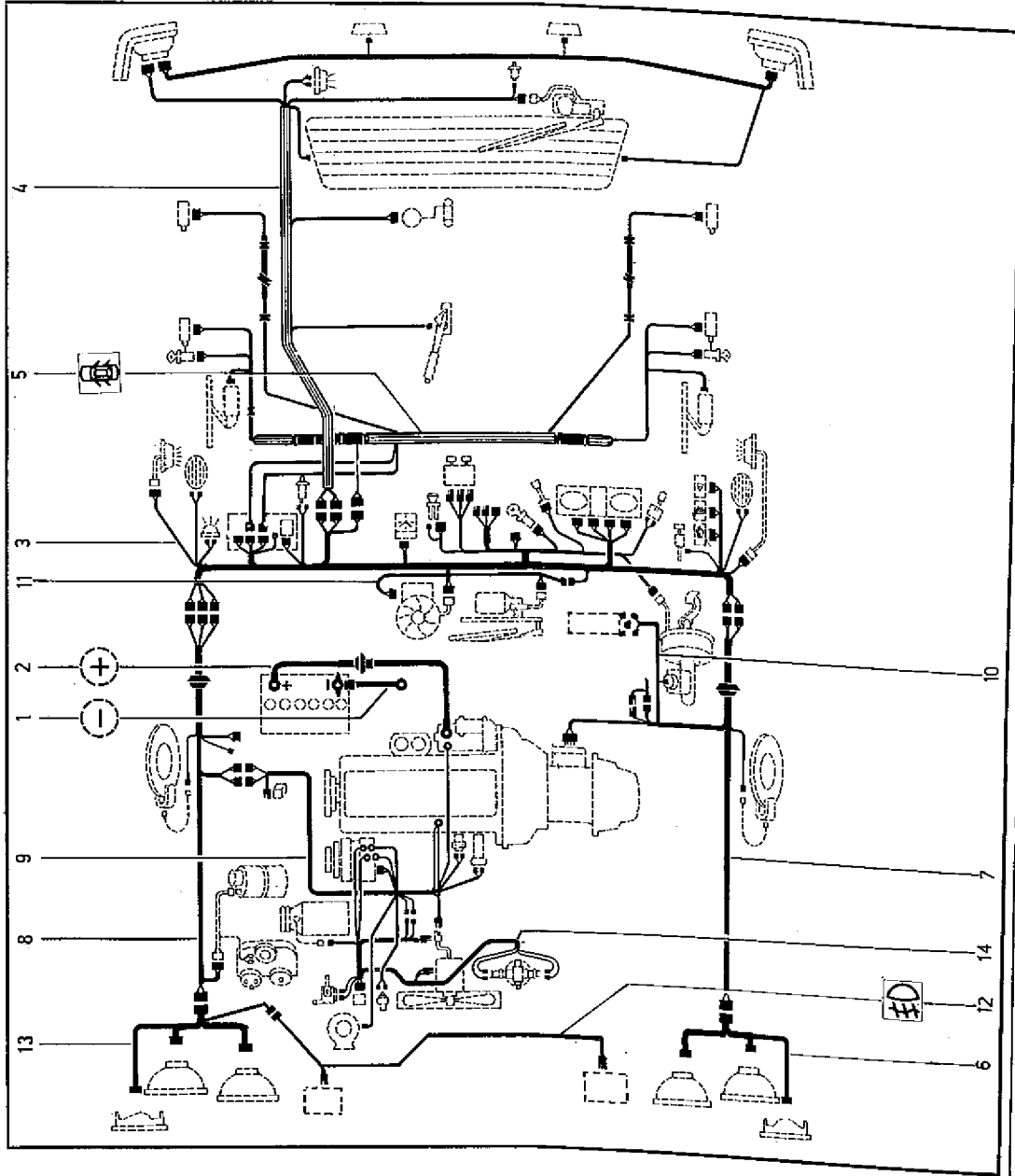
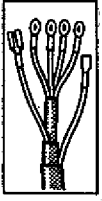

	(A) <input checked="" type="checkbox"/> E.A.T.
(f) / B37E <input checked="" type="checkbox"/> n° 003089 → n°	B37E <input checked="" type="checkbox"/> n° 002941
B373 <input checked="" type="checkbox"/> n° 026351 → n°	B373 <input checked="" type="checkbox"/> n° 027733
B37E <input checked="" type="checkbox"/> n° 001296 → n°	B37E <input checked="" type="checkbox"/> n° 002942 → n°
B37G <input checked="" type="checkbox"/> n° 002244 → n°	B373 <input checked="" type="checkbox"/> n° 027734 → n°
B373 <input checked="" type="checkbox"/> n° 022198 → n°	
(g) / B37E <input checked="" type="checkbox"/> n° 003089 → n°	
B373 <input checked="" type="checkbox"/> n° 026351 → n°	
B37E <input checked="" type="checkbox"/> n° 001296 → n°	
B37G <input checked="" type="checkbox"/> n° 002244 → n°	
B373 <input checked="" type="checkbox"/> n° 022198 → n°	
(e) / B37E <input checked="" type="checkbox"/> n° 000914 → n°	
B37G <input checked="" type="checkbox"/> n° 001709 → n°	
B373 <input checked="" type="checkbox"/> n° 020813 → n°	
(b) / B37E <input checked="" type="checkbox"/> n° 001354 → n° 003088	
B373 <input checked="" type="checkbox"/> n° 002244 → n°	
B373 <input checked="" type="checkbox"/> n° 022388 → n° 026350	
B37E <input checked="" type="checkbox"/> n° 000914 → n°	
B37G <input checked="" type="checkbox"/> n° 001709 → n°	
B373 <input checked="" type="checkbox"/> n° 020813 → n°	
(a) / B37E <input checked="" type="checkbox"/> n° 001354 → n° 003088	
B373 <input checked="" type="checkbox"/> n° 002244 → n°	
B373 <input checked="" type="checkbox"/> n° 022388 → n° 026350	
B37E <input checked="" type="checkbox"/> n° 000914 → n°	
B37G <input checked="" type="checkbox"/> n° 001709 → n°	
B373 <input checked="" type="checkbox"/> n° 020813 → n°	

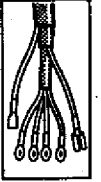

88.04.1
C.R. 1037

- 1 - 77 01 985 977
- 2 - 77 02 082 761
- 3 - 77 02 082 822
- 4 - 77 02 082 826
- 5 - 77 01 986 709
- 6 - 77 02 073 795
- 7 - 77 02 082 762
- 8 - 77 02 082 766 (a)
- 9 - 77 02 082 809 (b)
- 77 02 082 767 (a)
- 77 02 082 877 (b)
- 10 - 77 02 073 794

B 37G

88.04.1
C.R. 1037

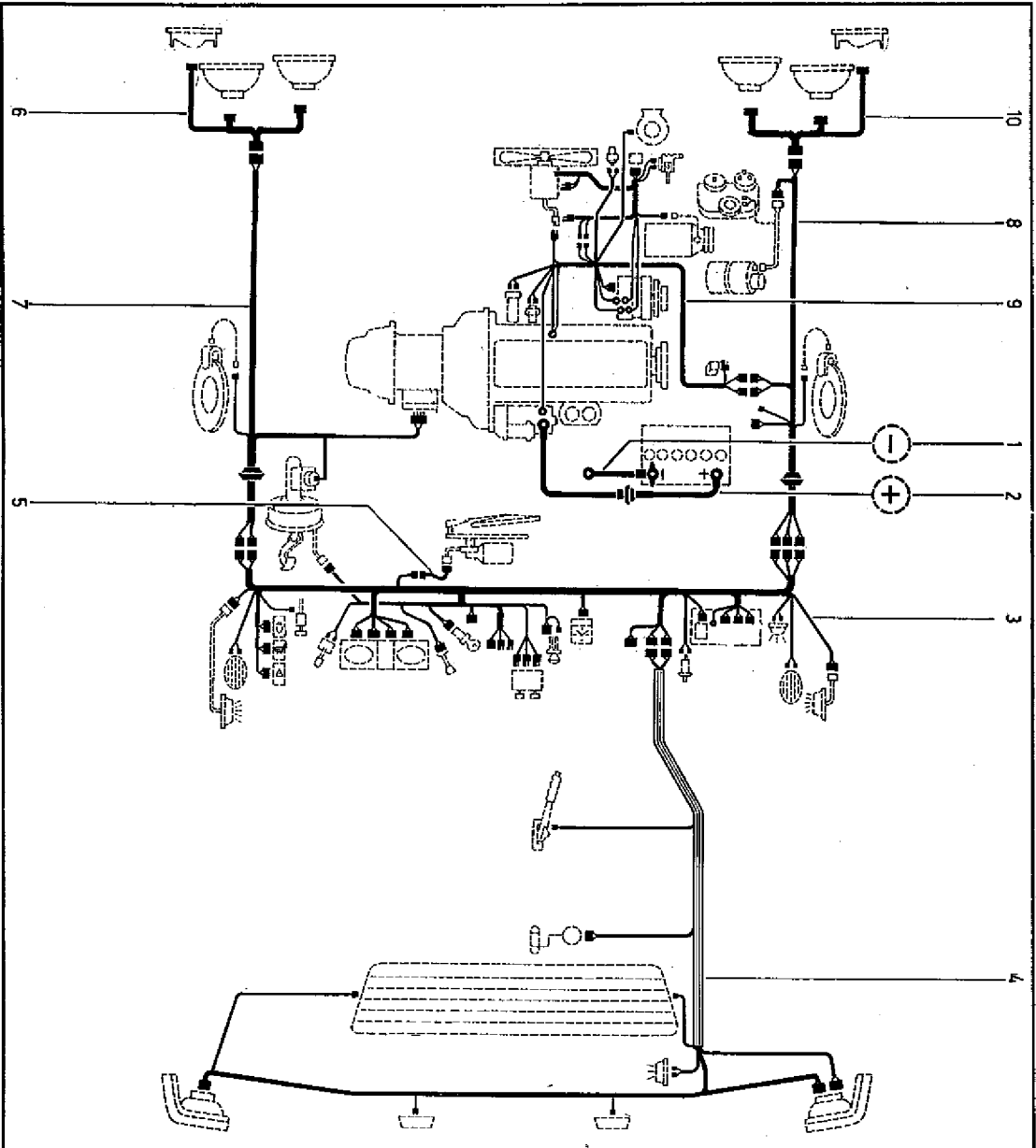
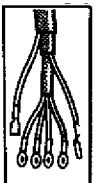

(a) B37G → n° 006620 → n° 08529
 (b) B37G → n° 08630 → n°

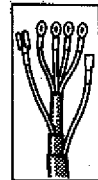

88.04.2
C.R.1037

- 1-77 01 985 977
- 2-77 02 082 761
- 3-77 02 082 822
- 4-77 02 082 826 (a)
- 5-77 02 082 835 (a)
- 6-77 02 082 824 (a)
- 7-77 02 073 795
- 8-77 02 082 762
- 9-77 02 082 766 (b)
- 10-77 02 082 809 (c)
- 11-77 02 082 726 (a)
- 12-77 02 082 825 (b)
- 13-77 01 986 806 C
- 14-77 02 073 794
- 15-77 02 082 840 (g)
- 16-77 02 082 767 (g)
- 17-77 02 082 877 (e)
- 18-77 01 986 709 (g)

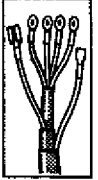
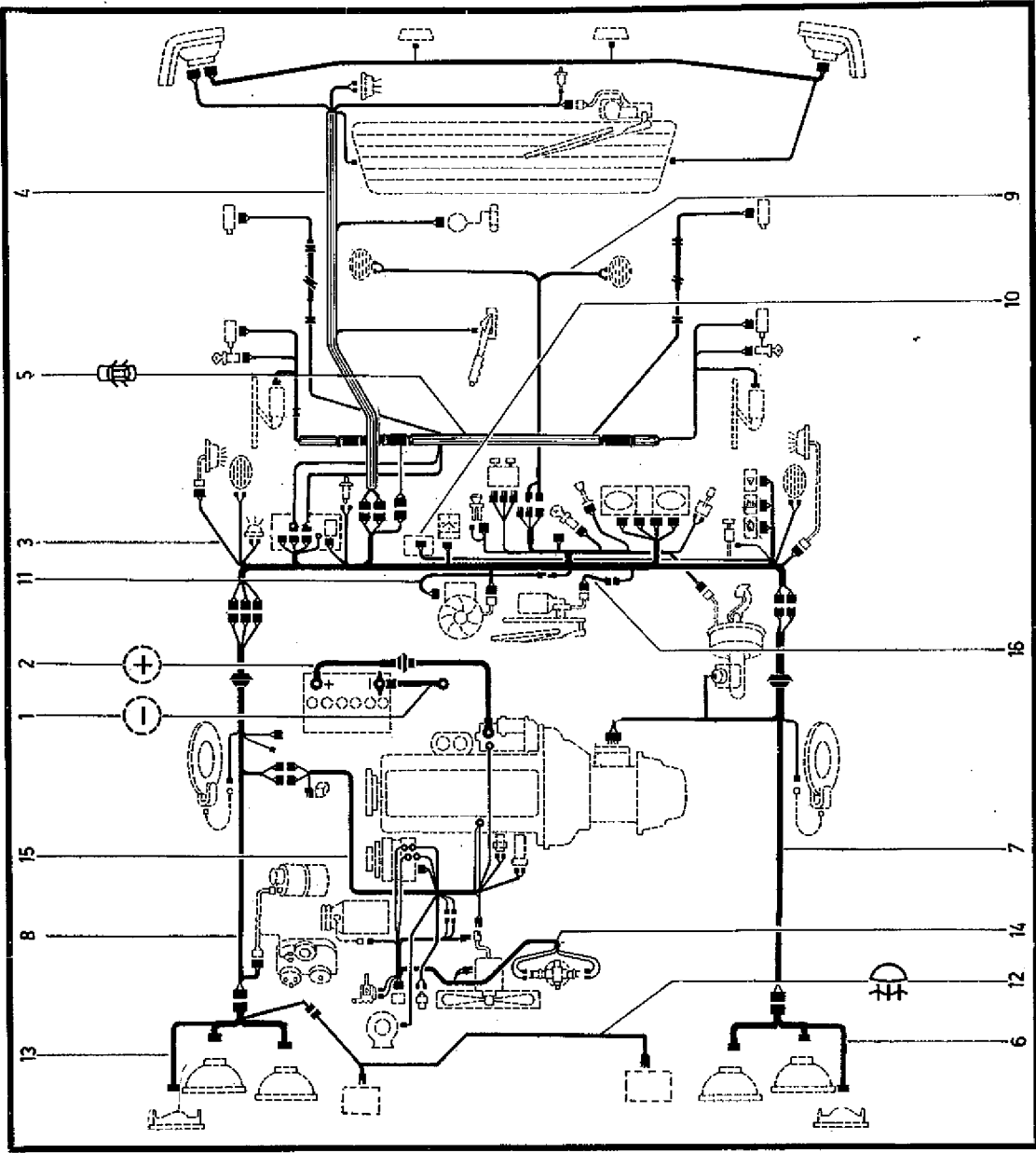

88.04.2
C.R.1037

(a)	B37T	1	n°	1	n°
	B373	1	n°	030734	n°
(b)	B37T	1	n°	1	n° 1054
	B373	1	n°	1	n° 32692

(c)	B37T	1	n°	1055	n°
	B373	1	n°	32693	n°
(d)	B373	1	n°	22196	n° 32692
(e)	B373	1	n°	32693	n°

(f)	B373	1	n°	028351	n° 32692
	B37T	1	n°	1	n° 1054
(g)	B373	1	n°	32693	n°
	B37T	1	n°	1055	n°

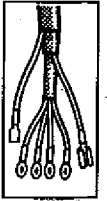

88.05
C.R.1037

- 1 - 77 01 985 977
- 2 - 77 02 082 662
- 3 - 77 02 082 664
- 4 - 77 02 082 669 (a)
- 5 - 77 02 082 699 (b)
- 6 - 77 02 082 723
- 7 - 77 02 082 777 (d)
- 8 - 77 02 082 656
- 9 - 77 02 082 653
- 10 - 77 01 988 094 +
- 11 - 77 02 082 661
- 12 - 77 02 082 684
- 13 - 77 02 082 583
- 14 - 77 02 073 794
- 15 - 77 02 082 657
- 16 - 77 02 082 663
- 17 - 77 02 082 666
- 18 - 77 02 082 668
- 19 - 77 02 082 665

B375

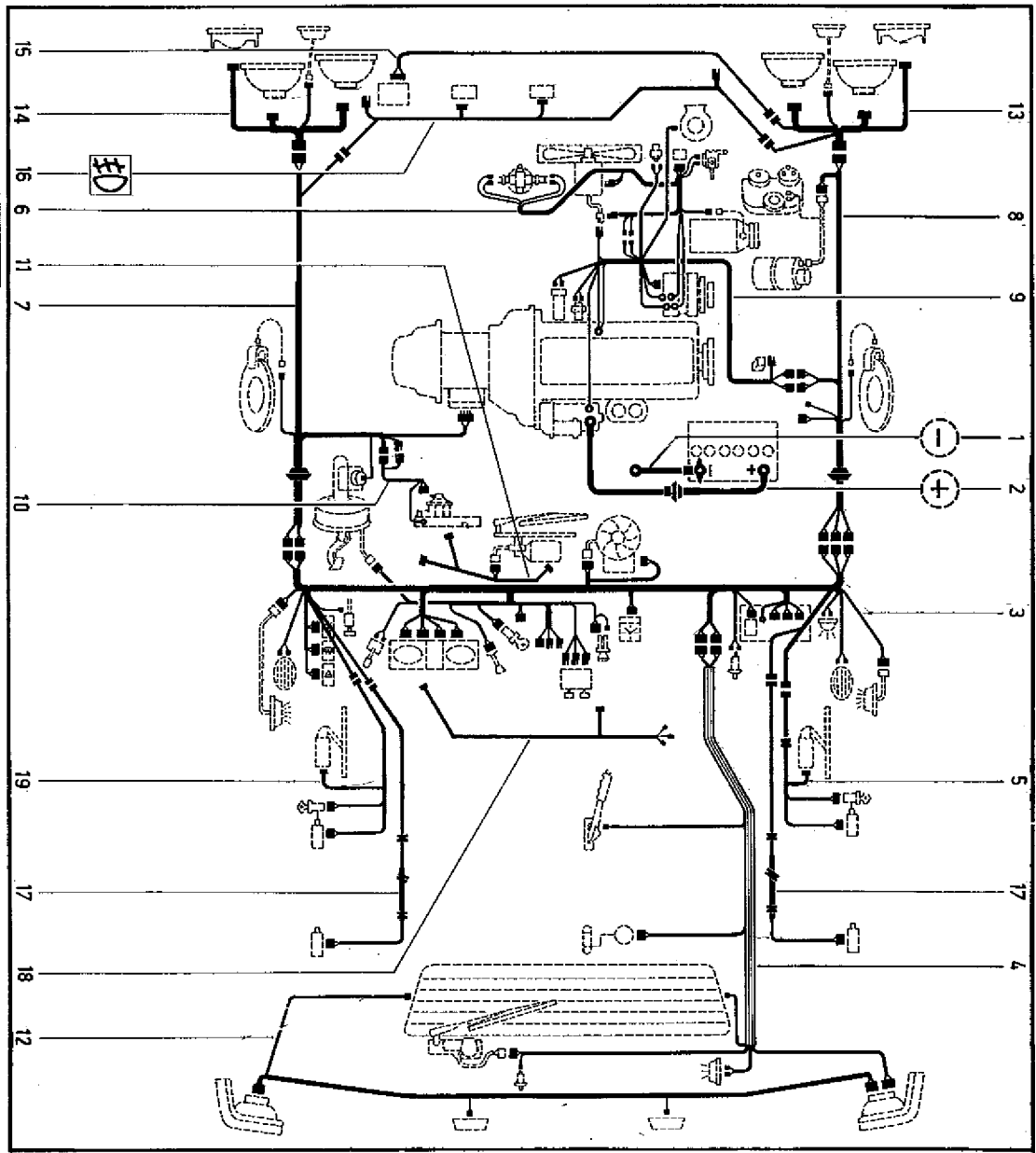

88.05
C.R.1037

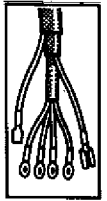

- (a) n° 1 n° 000408
- (b) n° 000408 n°
- (c) n° 1 n° 000418
- (d) n° 000428 n°

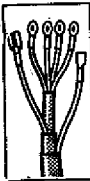

88.05.1
C.R.1037

B375

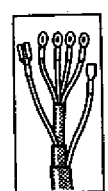
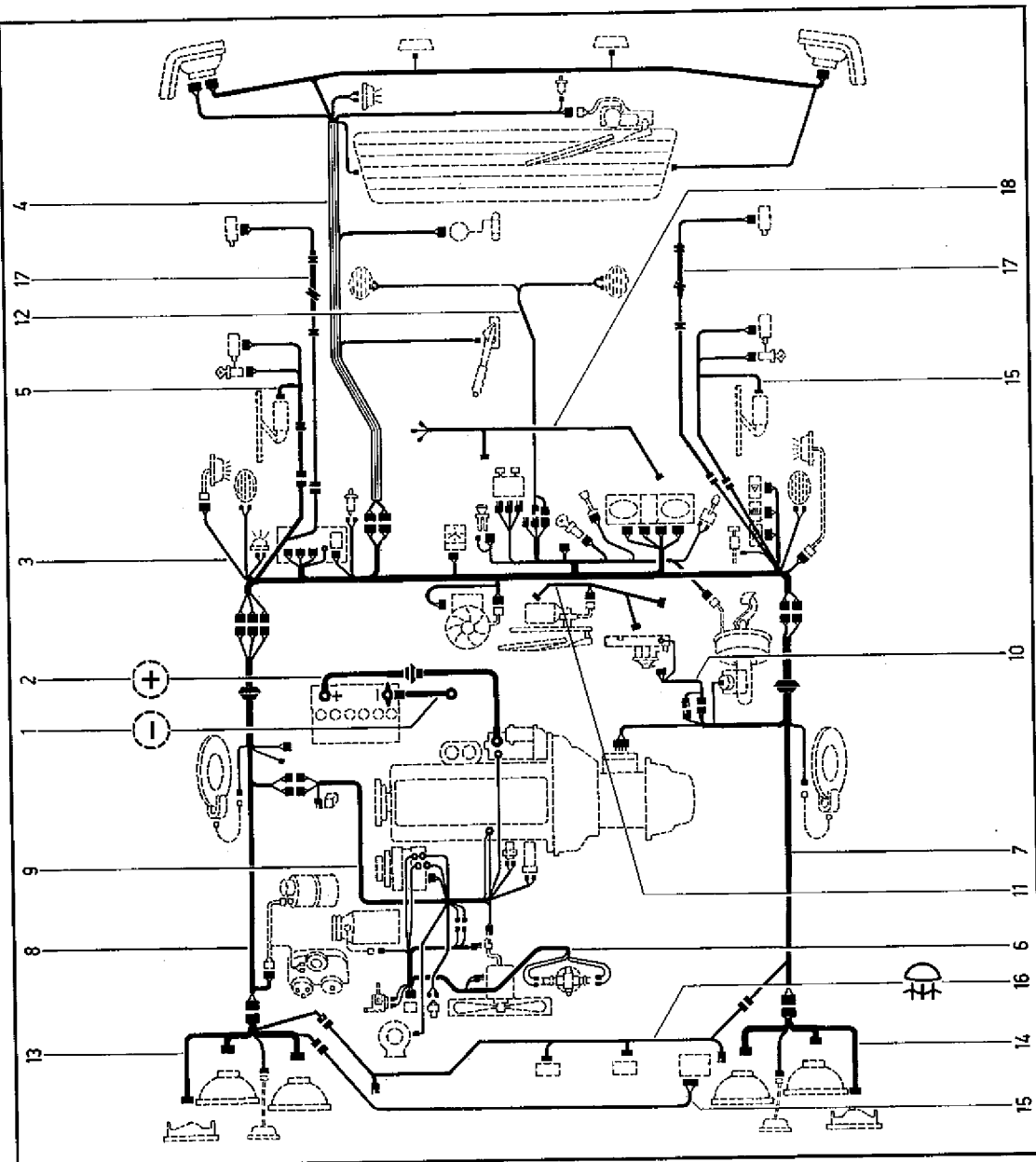

88.05.1
C.R.1037

- 1-77 01 985 977
- 2-77 02 082 662
- 3-77 02 082 838
- 4-77 02 082 819
- 5-77 02 082 836
- 6-77 02 082 777 (a)
- 7-77 02 082 828 (b)
- 7-77 02 082 656
- 8-77 02 082 654
- 9-77 02 082 653
- 10-77 02 082 661
- 11-77 02 082 659
- 12-77 02 082 670
- 13-77 02 073 794
- 14-77 02 073 795
- 15-77 02 082 837
- 16-77 02 082 663
- 17-77 02 082 666
- 18-77 02 082 821

B375	↕	n° 000732	↕	n° 810
(a) B375	↕	n° 420	↕	n° 811
(b) B375	↕	n° 811	↕	n° 811

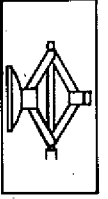

90.01
C.R.I1037

- 1 - 77 02 054 628
- 2 - 77 00 697 832
- 3 - 77 03 079 299
- 4 - 79 03 053 157
- 5 - 77 00 531 037
- 6 - 77 00 724 393

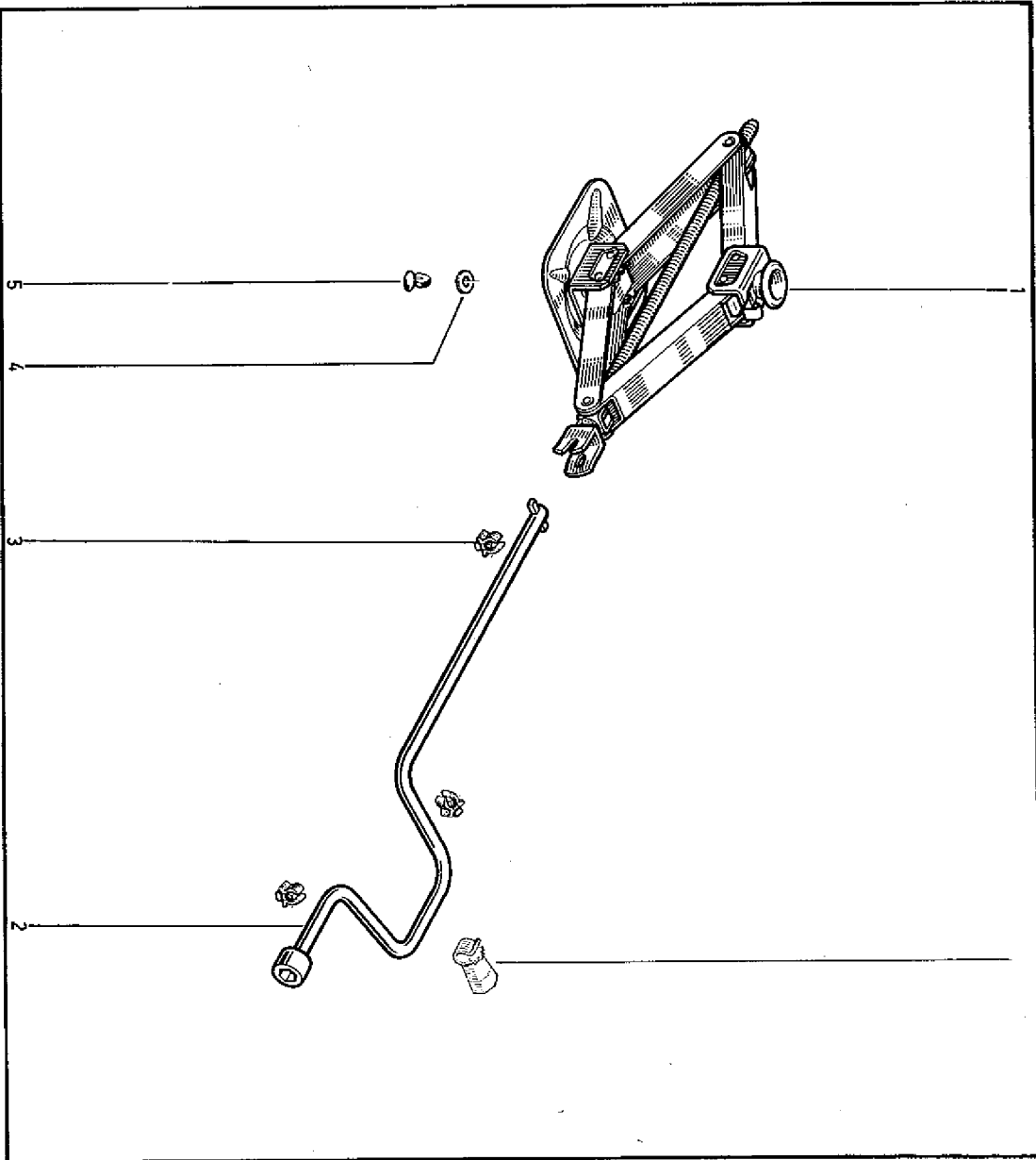

90.01
C.R.I1037

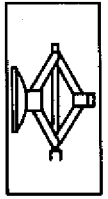





100.00
CR-1037

100.00
CR-1037



P I N T U R A	L A C A A C R I L I C A	CODIGO DE PINTURA	T A P I Z A D O	
			C O D I G O	C O L O R
02 24 928 400	ROJO APACHE	339	T-4852 / 4850 T-4853 / 4851	ARENA CENIZA
02 24 836 300	MARFIL VALENCIA	148	T-4852 / 4850 T-4853 / 4851	ARENA CENIZA
02 24 932 200	AZUL MALLORCA METALIZ. - BICAPA	342	T-4853 T-4851	CENIZA
02 24 689 800	ROJO IBERICO	235	T-4852 / 4850 T-4853 / 4851	ARENA CENIZA
02 24 836 000	VERDE ALGA METALIZADO	309	T-4852 T-4850	ARENA
02 24 900 700	BLANCO CHAPELCO	326	T-4852 / 4850 T-4853 / 4851	ARENA CENIZA
02 24 925 900	GRIS SEPIA METALIZADO - BICAPA	333	T-4851	CENIZA
02 24 925 800	BEIGE DUNA METALIZADO - BICAPA	334	T-4852 T-4850	ARENA
02 24 926 400	AZUL CREPUSCULO METALIZADO	335	T-4853 T-4851	CENIZA



100.01

CR-1037



100.01

CR-1037

P I N T U R A	L A C A A C R I L I C A	C O D I G O DE P I N T U R A	T A P I Z A D O	
			C O D I G O	C O L O R
02 24 928 500	GRIS HUSAR METALIZADO - BICAPA	340	T-4852 / 4850 T-4853 / 4851	ARENA CENIZA
02 24 928 600	GRIS ESCORIAL METALIZADO - BICAPA	341	T-4850 T-4851	ARENA CENIZA
02 24 926 200	BARNIZ Y ENDURECEDOR	---	---	---
02 24 926 300	DILUYENTE PARA BASE	---	---	---
02 24 928 700	DILUYENTE PARA BARNIZ	---	---	---



100.02

C.R. 1037

G A M A 1 9 8 5

100.02

C.R. 1037



C O L O R	P I E Z A N U M E R O	CODIGO PINTURA	T A P I Z A D O	
			C O D I G O	C O L O R
ROJO IBERICO	02 24 689 800	235	T-852 T-851/853	TELA PLASTICC ARENA TELA PLASTICO CENIZA
BLANCO CHAPELCO	02 24 900 700	326	T-850/852 T-851/853	TELA PLASTICO ARENA TELA PLASTICO CENIZA
GRIS HUSAR (BICAPA)	02 24 928 500	348	T-850/852 T-851/853	TELA PLASTICO ARENA TELA PLASTICO CENIZA
MARFIL VALENCIA	02 24 836 300	148	T-850/852 T-851/853	TELA PLASTICO ARENA TELA PLASTICO CENIZA
GRIS SEPIA (BICAPA)	02 24 925 900	333	T-851/853	TELA PLASTICO CENIZA
GRIS ESCORIAL (BICAPA)	02 24 928 600	341	T-850 T-851	TELA PLASTICO ARENA TELA PLASTICO CENIZA
BEIGE DUNA (BICAPA)	02 24 925 800	346	T-850/852	TELA PLASTICO ARENA
VERDE ESMERALDA (BICAPA)	02 24 991 700	349	T-850/852	TELA PLASTICO ARENA
VERDE SEQUOIA (BICAPA)	02 24 991 600	350	T-850/852	TELA PLASTICO ARENA



100.04

C.R. 1037

G A M A 1986

100.04

C.R. 1037



C O L O R	P I E Z A N U M E R O	CODIGO PINTURA	T A P I Z A D O S	
			C O D I G O	C O L O R
BLANCO CHAPELCO	02 24 900 700	326	353 354 316	TELA PLAST. MARRON TELA PLAST. CENIZA PLASTICO CENIZA
			341 342 345	TELA MARRON TELA CENIZA TELA CENIZA
GRIS SEPIA METALIZADO	02 24 925 900	333	353 341 345	TELA PLAST. MARRON TELA MARRON TELA CENIZA
GRIS ESCORIAL METALIZADO (BICAPA)	02 24 928 600	341	354 342 345	TELA PLAST. CENIZA TELA CENIZA TELA CENIZA
BEIGE DUNA METALIZADO (BICAPA)	02 24 925 800	346	353 354 341	TELA PLAST. MARRON TELA PLAST. CENIZA TELA MARRON
			342 345	TELA CENIZA TELA CENIZA
ROJO APACHE METALIZADO (BICAPA)	02 24 928 400	347	354 342 345	TELA PLAST. CENIZA TELA CENIZA TELA CENIZA
GRIS HUSAR METALIZADO (BICAPA)	02 24 928 500	348	354 342 345	TELA PLAST. CENIZA TELA CENIZA TELA CENIZA
AZUL POLARIS METALIZADO (BICAPA)	02 24 991 800	351	354 342 345	TELA PLAST. CENIZA TELA CENIZA TELA CENIZA



100.05

C.R. 1037

G A M A 1 9 8 6



100.05

C.R. 1037

C O L O R	P I E Z A N U M E R O	C O D I G O P I N T U R A	T A P I Z A D O S	
			C O D I G O	C O L O R
MARFIL TAMPICO	02 24 998 600	353	353 354 341	TELA PLAST. MARRON TELA PLAST. CENIZA TELA MARRON
			342 345	TELA CENIZA TELA CENIZA
ROJO MODENA	02 24 998 900	355	354 342 345	TELA PLAST. CENIZA TELA CENIZA TELA CENIZA
VERDE ORLEANS METALIZADO (BICAPA)	02 24 999 100	356	341 342 345	TELA MARRON TELA CENIZA TELA CENIZA
AZUL ANTIBES METALIZADO (BICAPA)	02 24 999 000	357	354 342 345	TELA PLAST. CENIZA TELA CENIZA TELA CENIZA
COBRE FLORENTINO METALIZADO	02 24 952 500	370	354 342 345	TELA PLAST. CENIZA TELA CENIZA TELA CENIZA
BEIGE PUCARA	02 24 952 600	371	353 354	TELA PLAST. MARRON TELA PLAST. CENIZA
			341 342 345	TELA MARRON TELA CENIZA TELA CENIZA



100.07

G A M A 1 9 8 9

100.07

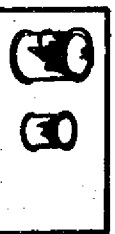

C O L O R	N U M E R O	C O D. PINT.:	T A P I Z A D O S	
			C O L O R	C O D I G O
Bianco Chapelco (Poliuretánico)	02 24 998 800	326	Tela Plástico } Arena	T - 352 T - 452
			Tela Plástico } Ceniza	T - 356 T - 453
			Tela } Borravino	T - 344 T - 445
			Tela } Ceniza	T - 345 T - 446
			Tela } Borravino	T - 347 T - 447
			Tela } Gris Celta	T - 348 T - 448
Granate Oriental Metalizado	02 24 957 700	367	Tela } Borravino	T - 344 T - 445
			Tels } Ceniza	T - 345 T - 446
			Tela } Borravino	T - 347 T - 447
Negro Eclipse Metalizado	02 24 958 000	368	Tela Plástico } Ceniza	T - 356 T - 453
			Tela Ceniza	T - 346



100.07.1



100.07.1

G A M A 1 9 8 9

C O L O R	N U M E R O	C O D . P I N T . :	T A P I Z A D O S	
			C O L O R	C O D I G O
Gris Fragata	02 24 957 800	373	Tela	T - 345
			Tela} Ceniza	T - 446
Azul Orion Metalizado	02 24 957 900	378	Tela	T - 348
			Tela} Gris Celt.	T - 448
Azul Orion Metalizado	02 24 957 900	378	Tela	T - 356
			Tela} Plástico} Ceniza	T - 453
			Tela	T - 345
			Tela} Ceniza	T - 446
			Tela	T - 348
			Tela} Gris Celt.	T - 448
Verde Musgo Metalizado	02 24 958 300	383	Tela	T - 352
			Tela} Plástico} Arena	T - 452
			Tela	T - 345
			Tela} Ceniza	T - 446
			Tela	T - 348
			Tela} Gris Celt.	T - 448
Azul Apolo Metalizado	02 25 067 700	392	Tela	T - 348
			Tela} Gros Celt.	T - 448
Gris Titanio Metalizado	02 25 067 800	393	Tela	T - 352
			Tela} Plástico} Arena	T - 452
			Tela	T - 356
			Tela} Plástico} Ceniza	T - 453
			Tela	T - 344
			Tela} Borravino	T - 445



100.07.2

G A M A 1 9 8 9

100.07.2



C O L O R	N U M E R O	C O D . P I N T . :	T A P I Z A D O S	
			C O L O R	C O D I G O
			Tela Tela } Ceniza	T - 345 T - 446
			Tela Tela } Borravino	T - 347 T - 447
			Tela Tela } Gris Celta	T - 348 T - 448
			Tela Negra	T - 340
			Tela Tela } Plástico } Arena	T - 352 T - 452
			Tela Tela } Borravino	T - 344 T - 445
			Tela Tela } Borravino	T - 347 T - 447
			Tela Tela } Plástico } Arena	T - 352 T - 452
			Tela Tela } Plástico } Ceniza	T - 356 T - 453
			Tela Tela } Ceniza	T - 345 T - 446
			Tela Tela } Gris Celta	T - 348 T - 448
			Tela Negra Tela Ceniza	T - 340 T - 346
Beige Oran Poliuretánico	02 25 067 500	394	Tela Tela } Plástico } Arena	T - 352 T - 452
			Tela Tela } Borravino	T - 344 T - 445
			Tela Tela } Borravino	T - 347 T - 447
Rojo Ibiza Poliuretánico	02 25 067 600	395	Tela Tela } Plástico } Arena	T - 352 T - 452
			Tela Tela } Plástico } Ceniza	T - 356 T - 453
			Tela Tela } Ceniza	T - 345 T - 446
			Tela Tela } Gris Celta	T - 348 T - 448
			Tela Negra Tela Ceniza	T - 340 T - 346



1	2	1	2	1	2	1	2	1	2
7700523648	76-02	7700612542	16-01	7700643241	57-01	7700662674	36-12	7700677783	19-50
7700525087	11-40	7700612543	16-01	7700643243	35-01	7700662741	38-01	7700678292	31-30
7700531037	90-00	7700614940	60-20	7700646134	79-01	7700662742	38-01	7700678323	36-10
7700531733	29-01	7700615445	44-01	7700647358	21-45	7700662770	38-01	7700678531	80-30
7700532135	19-30	7700615808	85-18	7700647657	10-60	7700662771	38-01	7700678542	19-80
7700536796	12-05	7700616085	85-03	7700648232	21-60	7700662781	38-01	7700678564	21-40
7700538796	12-10	7700616085	85-06	7700648232	21-65	7700662782	38-01	7700678564	21-45
7700538274	13-45	7700616988	37-60	7700648234	21-60	7700662783	38-01	7700678565	21-45
7700539049	38-01	7700618184	11-40	7700648234	21-65	7700662784	38-01	7700678568	21-45
7700542495	12-02	7700624458	85-03	7700648261	57-30	7700663286	35-01	7700678581	78-10
7700544419	83-05	7700624458	85-06	7700648882	72-15	7700663500	21-30	7700678581	78-11
7700544419	83-06	7700625952	37-50	77006651421	77-10	7700664119	21-50	7700678581	78-12
7700547334	59-20	7700630267	35-01	77006651421	77-101	7700664915	21-50	7700678597	36-30
7700547334	59-50	7700631558	72-15	77006651421	77-102	7700665249	36-12	7700678621	42-01
7700551538	84-20	7700631906	16-01	77006651422	77-10	7700665249	36-12	7700678649	36-10
7700553137	38-01	7700632139	37-30	77006651422	77-101	7700666112	11-40	7700678679	31-01
7700555615	10-70	77006324732	43-01	77006651422	77-102	77006667526	10-80	7700678680	31-01
7700557850	34-01	7700634733	43-01	77006651423	77-10	7700667527	10-80	7700678688	13-28
7700563649	36-30	7700634733	43-01	77006651640	11-40	7700667527	17-05	7700678722	28-01
7700566235	11-20	7700635003	87-52	77006651641	11-40	7700667652	17-12	7700678723	38-01
7700566235	11-20	7700635003	87-52	77006651641	11-40	7700667652	17-12	7700678723	38-01
7700567500	13-31	7700636358	35-01	77006653337	38-20	7700667703	21-40	7700678762	84-20
7700567740	10-40	7700636359	35-01	77006653447	53-01	7700667703	21-45	7700678777	13-40
7700571998	50-50	7700636360	35-01	77006653459	36-10	7700668275	35-01	7700678778	13-40
7700573714	75-10	7700636361	35-01	77006654476	61-201	7700668694	34-01	7700678780	21-60
7700575126	77-05	7700636362	35-01	77006654941	52-20	7700669692	12-01	7700678780	21-65
7700576366	37-60	7700636363	35-01	77006655167	50-40	7700671600	13-42	7700678810	21-60
7700577010	19-30	7700636364	35-01	77006655167	50-50	7700672198	10-70	7700678810	21-65
7700578993	17-11	7700636758	50-60	77006655168	50-40	7700672304	61-20	7700678814	19-80
7700579550	38-20	7700637825	50-65	77006655168	50-50	7700672817	59-50	7700678815	19-80
7700579550	38-20	7700637825	85-03	77006655195	11-40	7700673266	43-01	7700679013	46-01
7700579928	11-40	7700637825	85-06	77006655281	54-01	7700673971	59-20	7700679014	46-01
7700581372	10-60	7700638476	17-05	77006655281	58-20	7700674643	41-10	7700679094	41-10
7700581673	37-50	7700638476	17-12	77006655331	11-40	7700674644	41-10	7700679141	12-15
7700582463	37-60	7700638976	87-40	77006655335	11-40	7700674884	64-01	7700679144	13-45
7700587337	50-15	7700639125	37-70	77006655556	11-01	7700675366	12-01	7700679315	36-10
7700587337	50-20	7700639573	10-40	77006655787	10-70	7700675931	11-30	7700679319	36-10
7700587337	50-25	7700639743	59-20	77006656205	21-45	7700676012	84-30	7700679379	41-10
7700587338	50-15	7700639888	59-50	77006656238	12-05	7700676237	58-30	7700679614	37-01
7700587338	50-15	7700639888	50-15	77006656379	12-10	7700676238	58-30	7700679617	37-01
7700587338	50-15	7700639888	50-15	77006656379	32-30	7700676262	13-03	7700679618	37-01
7700587338	50-20	7700639888	50-20	77006659275	36-10	7700676570	72-15	7700679620	37-01
7700587338	50-25	7700639888	50-25	77006659275	36-12	7700676571	72-15	7700679621	37-01
7700589318	13-24	7700639889	50-10	77006659817	64-01	7700676701	34-30	7700679691	10-50
7700591156	16-01	7700639889	50-15	77006660487	21-65	7700667029	34-32	7700679693	10-50
7700591208	38-01	7700639889	50-20	77006660488	21-60	7700677029	31-40	7700679885	42-10
7700591241	38-01	7700640963	50-25	77006660488	21-65	7700677033	31-40	7700679909	44-01
7700611935	21-50	7700641938	56-01	77006661616	36-10	7700677033	31-40	7700679910	44-01
7700612290	17-20	7700642113	64-01	77006662571	36-10	7700677115	11-30	7700679912	43-01
7700612542	13-80	7700642478	10-40	77006662571	36-12	7700677333	19-60	7700679913	43-01
7700612542	13-80	7700642478	15-40	77006662674	36-10	7700677758	31-40	7700679914	43-01

indice numerico

1	2	1	2	1	2	1	2	1	2
7700679919	37-01	7700682768	65-01	7700687152	43-01	7700692265	58-30	7700695744	84-20
7700679937	52-01	7700682769	65-01	7700687315	42-01	7700692381	71-01	7700695993	62-35
7700679960	21-60	7700682856	64-01	7700687327	19-30	7700692904	60-10	7700695994	62-35
7700679960	21-65	7700683146	19-01	7700687383	33-01	7700692907	62-35	7700695994	62-35
7700679967	21-65	7700683294	71-01	7700687386	37-80	7700692907	62-35	7700695994	62-35
7700679967	21-65	7700683295	71-01	7700687388	37-80	7700693020	77-01	7700695994	62-35
7700680097	32-10	7700683560	19-50	7700687390	37-80	7700693155	32-10	7700695994	62-35
7700680098	32-10	7700683560	72-15	7700687392	37-80	7700693172	31-40	7700695994	62-35
7700680167	13-03	7700684042	57-01	7700687394	37-80	7700693173	31-40	7700695994	62-35
7700680261	21-45	7700684043	57-01	7700687396	37-80	7700693527	75-15	7700695994	62-35
7700680351	10-40	7700684044	57-01	7700687428	36-30	7700693847	37-01	7700696719	38-20
7700680394	71-01	7700684089	83-10	7700687437	13-04	7700693946	13-28	7700696721	38-20
7700680476	42-10	7700684090	29-01	7700687550	19-04	7700693949	75-15	7700696835	58-40
7700680585	56-21	7700684343	29-01	7700687550	19-04	7700693965	75-15	7700696836	58-40
7700680586	56-21	7700684403	29-01	7700687914	58-40	7700693981	75-15	7700696836	50-54
7700680648	42-01	7700684429	13-04	7700687914	58-40	7700694013	75-01	7700696836	50-54
7700680811	21-50	7700684501	21-50	7700688235	33-01	7700694217	57-01	7700696836	50-54
7700680836	37-01	7700684504	10-60	7700688253	21-40	7700694218	57-01	7700696836	50-54
7700680837	37-01	7700684566	68-01	7700688253	21-45	7700694219	57-01	7700696836	50-54
7700680852	36-10	7700684566	72-15	7700688254	21-30	7700694220	57-01	7700696836	50-54
7700681144	37-01	7700684904	72-15	7700688983	83-10	7700694221	57-01	7700696836	50-54
7700681260	34-10	7700685303	50-01	7700688970	19-41	7700694222	37-01	7700696836	50-54
7700681400	36-30	7700685496	57-01	7700688970	19-40	7700694264	37-01	7700696836	50-54
7700681418	11-01	7700685497	57-01	7700688983	71-10	7700694279	11-40	7700696836	50-54
7700681803	48-01	7700685500	57-01	7700688993	64-01	7700694394	68-01	7700696836	50-54
7700682058	41-20	7700685501	57-01	7700689011	57-30	7700694461	35-01	7700696836	50-54
7700682064	11-40	7700685565	37-80	7700689012	11-40	7700694461	35-01	7700696836	50-54
7700682219	19-50	7700685567	37-80	7700689300	86-01	7700694733	38-20	7700696836	50-54
7700682235	66-01	7700685683	38-01	7700689300	58-40	7700694733	38-20	7700696836	50-54
7700682236	66-01	7700685683	21-40	7700689338	21-20	7700694788	75-15	7700696836	50-54
7700682240	66-01	7700685833	21-45	7700689436	58-40	7700694789	75-15	7700696836	50-54
7700682242	66-01	7700685833	50-30	7700689436	84-01	7700694811	41-30	7700696836	50-54
7700682244	66-01	7700685864	50-30	7700689473	84-01	7700695038	21-20	7700696836	50-54
7700682245	66-01	7700685864	37-01	7700689474	84-01	7700695264	57-01	7700696836	50-54
7700682247	66-01	7700685998	19-30	7700689475	84-10	7700695266	57-01	7700696836	50-54
7700682248	66-01	7700686028	17-30	7700689476	84-20	7700695267	57-01	7700696836	50-54
7700682250	66-01	7700686136	64-01	7700689103	36-30	7700695372	72-03	7700696836	50-54
7700682251	66-01	7700686185	42-01	7700689109	66-01	7700695373	72-03	7700696836	50-54
7700682251	66-01	7700686365	19-01	7700689109	66-01	7700695373	72-03	7700696836	50-54
7700682251	21-30	7700686367	19-01	7700689109	66-01	7700695373	72-03	7700696836	50-54
7700682283	71-01	7700686390	19-01	7700689114	66-01	7700695378	72-03	7700696836	50-54
7700682284	71-01	7700686429	42-10	7700689146	61-01	7700695378	72-03	7700696836	50-54
7700682285	71-01	7700686449	19-50	7700689152	57-01	7700695379	72-03	7700696836	50-54
7700682286	71-01	7700686449	19-60	7700689160	13-20	7700695379	72-03	7700696836	50-54
7700682392	37-01	7700686473	11-40	7700689194	29-01	7700695566	38-20	7700696836	50-54
7700682421	38-01	7700686546	46-10	7700689207	60-10	7700695566	38-20	7700696836	50-54
7700682522	71-01	7700686546	58-30	7700689216	60-10	7700695569	38-20	7700696836	50-54
7700682617	66-01	7700686671	84-20	7700689216	60-10	7700695569	38-20	7700696836	50-54
7700682620	66-01	7700686671	35-01	7700689216	12-05	7700695581	10-50	7700696836	50-54
7700682621	66-01	7700686691	43-01	7700689216	12-10	7700695637	37-70	7700696836	50-54
7700682665	37-70	7700686715	43-01	7700689216	12-15	7700695677	36-30	7700696836	50-54

1	2	1	2	1	2	1	2	1	2
7700699064	38-01	7700706126	12-15	7700709375	87-30	7700712616	41-30	7700716580	12-02
7700699337	43-01	7700706206	31-01	7700709467	71-10	7700712672	77-05	7700717104	76-01
7700699338	43-01	7700706549	21-40	7700709468	71-10	7700712801	71-01	7700717122	13-35
7700699359	48-01	7700706549	21-45	7700709539	71-01	7700712802	71-01	7700717259	21-30
7700699350	48-01	7700706754	11-20	7700709540	71-01	7700712809	71-01	7700717385	21-50
7700699569	19-30	7700706839	12-50	7700709541	71-01	7700712817	71-01	7700717386	21-50
7700699619	19-30	7700706839	12-50	7700709542	71-01	7700712818	71-01	7700717439	10-60
7700699742	55-10	7700707070	17-11	7700709844	36-30	7700712821	71-01	7700717441	10-60
7700699743	55-10	7700707106	12-50	7700709860	71-05	7700712822	71-01	7700717627	64-01
7700699951	57-01	7700707107	12-50	7700709861	71-05	7700713014	57-01	7700717694	36-12
7700700301	87-52	7700707118	38-01	7700709890	80-01	7700713016	83-08	7700717740	41-30
7700700370	19-01	7700707261	13-30	7700710022	85-18	7700713017	83-08	7700717846	41-30
7700701090	71-10	7700707351	36-30	7700710098	36-30	7700713689	77-05	7700717867	41-30
7700701092	55-01	7700707368	17-05	7700710231	11-40	7700713690	77-05	7700717876	35-01
7700701597	37-01	7700707382	37-01	7700710232	11-40	7700713829	71-10	7700718096	77-01
7700701608	37-60	7700707473	36-01	7700710507	33-40	7700713830	71-10	7700718096	77-05
7700701831	19-50	7700707720	71-01	7700710626	71-05	7700713844	57-01	7700718102	19-80
7700701902	10-40	7700707721	71-01	7700710633	21-20	7700713845	57-01	7700718362	77-05
7700701955	38-20	7700707722	71-01	7700710669	76-02	7700713975	76-01	7700718575	86-30
7700702321	21-60	7700707723	71-01	7700710695	76-02	7700713975	76-02	7700718789	78-10
7700702828	55-02	7700707877	74-01	7700711027	76-01	7700714012	50-40	7700718856	21-60
7700702829	55-02	7700707878	74-01	7700711044	76-01	7700714012	50-50	7700718856	21-65
7700702839	71-01	7700707883	74-01	7700711045	76-01	7700714039	42-10	7700718956	21-45
7700702840	71-01	7700707884	74-01	7700711045	76-02	7700714040	42-10	7700718959	21-45
7700703000	21-65	7700707886	74-01	7700711046	76-01	7700714041	43-01	7700718961	21-45
7700703078	71-01	7700707886	74-01	7700711046	76-02	7700714042	43-01	7700718963	21-40
7700703079	71-01	77007078006	16-01	7700711058	58-40	7700714043	42-01	7700718963	21-45
7700703348	53-01	77007078040	71-01	7700711328	55-10	7700714379	50-40	7700718985	11-30
7700703716	75-01	77007078041	71-01	7700711329	55-10	7700714380	50-50	7700719076	11-40
7700703865	46-10	77007078042	71-01	7700711341	76-02	7700714383	50-50	7700719651	48-01
7700703940	38-01	77007078043	71-01	7700711342	76-02	7700714393	74-01	7700720240	21-45
7700703941	38-01	77007078044	71-01	7700711486	75-01	7700714394	74-01	7700720347	21-45
7700704136	53-01	77007078045	71-01	7700711550	75-01	7700714974	13-45	7700720350	21-45
7700704479	46-10	77007078046	71-01	7700711583	50-40	7700714975	12-15	7700720396	21-45
7700704480	46-10	77007078047	71-01	7700711583	50-50	7700715263	75-01	7700720526	21-45
7700704703	32-01	77007078152	21-40	7700711584	50-40	7700715371	35-01	7700720766	21-45
7700704704	31-40	77007078196	21-45	7700711584	50-50	7700715482	13-81	7700720854	21-50
7700704705	31-40	77007078196	75-01	7700711585	50-40	7700715532	35-01	7700720885	21-40
7700704840	72-03	77007078197	12-01	7700711585	50-50	7700715684	13-30	7700720886	21-40
7700704841	72-03	77007078201	12-01	7700711846	62-35	7700715851	21-60	7700720886	21-45
7700704844	72-03	77007078317	16-01	7700711901	71-05	7700715851	21-65	7700720971	21-20
7700704845	72-03	77007078440	21-60	7700711902	62-35	7700715852	21-65	7700721610	11-30
7700704831	32-01	77007078540	21-65	7700711903	62-35	7700715920	62-35	7700721928	21-50
7700704958	21-30	77007078548	56-21	7700711904	62-35	7700715920	62-35	7700722023	21-50
7700705253	46-10	77007078548	56-21	7700711929	42-10	7700716084	56-21	7700722303	21-50
7700705434	12-15	77007078619	11-40	7700711939	71-10	7700716084	56-21	7700722304	21-50
7700705444	12-15	77007078710	19-01	7700711939	58-40	7700716084	56-21	7700722442	50-01
7700705444	71-01	77007078747	13-28	7700712536	71-10	7700716188	12-01	7700722443	50-01
7700705445	71-01	77007078747	10-60	7700712537	71-10	7700716309	12-18	7700722443	43-01
7700705607	36-12	77007078251	10-60	7700712548	52-20	7700716310	12-18	7700722443	43-01
		77007079328	31-01	7700712549	52-20	7700716409	76-01	7700722762	11-01

indice numerico

1	2	1	2	1	2	1	2	1	2
7700722801	21-20	77007227849	21-45	77007471299	21-50	77007527394	55-02	7700757086	19-30
7700722933	12-10	77007227851	21-45	77007501185	80-01	7700752811	31-40	7700757168	41-30
7700722940	21-60	77007227887	38-20	7700750211	13-35	7700753009	85-18	7700757189	50-70
7700722944	21-65	77007227965	20-01	7700750314	58-40	7700753050	19-50	7700757190	50-70
7700722944	38-20	77007227971	38-20	7700750315	58-40	7700753133	52-20	7700757220	74-01
7700722942	38-20	77007228024	58-30	7700750315	58-40	7700753206	19-04	7700757226	74-01
7700723002	10-60	77007228024	84-20	7700750836	60-10	7700753294	44-01	7700757228	74-01
7700723167	21-45	77007228024	17-12	7700750856	74-01	7700753295	44-01	7700757236	12-55
7700723324	80-01	77007228749	38-20	7700750857	74-01	7700753309	52-20	7700757268	37-30
7700723384	21-50	77007228823	21-40	7700750865	74-01	7700753340	87-40	7700757408	36-40
7700723388	21-65	77007228826	21-40	7700750866	74-01	7700753345	19-60	7700757435	46-10
7700723507	21-45	77007229282	10-40	7700750858	81-01	7700753350	37-01	7700757547	13-03
7700723611	12-15	77007229283	21-50	7700750859	81-01	7700753351	57-01	7700757549	13-03
7700723654	21-50	77007229385	20-01	7700751020	42-10	7700753603	71-10	7700757554	62-35
7700723987	11-30	77007229838	17-11	7700751283	53-15	7700753858	48-01	7700757554	62-35
7700724120	10-40	7700730387	21-60	7700751285	55-15	7700754018	33-40	7700757789	50-20
7700724305	20-01	7700730387	21-65	7700751288	55-15	7700754024	19-04	7700757790	50-20
7700724393	90-01	7700731015	35-01	7700751288	55-15	7700754024	19-04	7700757791	50-10
7700724459	21-50	7700731151	21-45	7700751289	55-15	7700754044	19-04	7700757792	50-10
7700724558	21-50	7700731154	21-45	7700751290	55-15	7700754045	46-10	7700757947	36-12
7700724559	21-40	7700731206	11-40	7700751291	55-15	7700754131	61-01	7700758287	84-30
7700724825	83-10	7700731524	35-01	7700751292	55-15	7700754144	53-01	7700758309	76-02
7700724921	21-50	7700732100	13-20	7700751335	85-18	7700754196	31-30	7700758311	76-02
7700725237	20-01	7700732133	21-30	7700751343	56-01	7700754258	57-01	7700758313	76-02
7700725283	21-30	7700732235	21-45	7700751347	56-01	7700754260	87-30	7700758319	87-52
7700725283	21-30	7700732243	12-18	7700751355	56-01	7700754271	55-01	7700758640	76-02
7700725719	21-60	7700732443	86-20	7700751356	56-01	7700754272	55-01	7700758641	76-01
7700725720	21-65	7700732503	86-20	7700751514	46-10	7700754282	56-01	7700758642	76-02
7700725846	21-60	7700732506	86-20	7700751515	66-01	7700754283	56-01	7700758712	52-20
7700725865	21-20	7700732507	35-01	7700751555	42-10	7700754290	52-20	7700758714	52-20
7700725868	21-20	7700732841	12-18	7700751798	81-40	7700754392	56-01	7700758970	19-50
7700725904	21-60	7700732907	11-20	7700751937	21-30	7700754393	33-40	7700758977	19-10
7700725904	21-65	7700733041	21-20	7700751938	19-01	7700754394	87-40	7700758995	33-40
7700725911	21-65	7700733336	12-05	7700751988	62-35	7700754507	87-40	7700759019	46-10
7700725962	21-40	7700733343	21-45	7700752055	36-01	7700755267	87-40	7700759319	58-30
7700725962	21-45	7700733460	21-45	7700752093	36-01	7700755267	10-70	7700759383	58-30
7700725987	21-65	7700733460	20-01	7700752102	84-20	7700755752	10-80	7700759385	37-30
7700725987	21-65	7700733461	35-01	7700752121	84-20	7700755604	84-30	7700759386	37-30
7700726011	17-12	7700735123	35-01	7700752220	19-50	7700755613	87-30	7700759387	55-40
7700726056	12-50	7700735125	35-01	7700752234	19-50	7700755620	87-40	7700759418	36-30
7700726562	12-50	7700735177	35-01	7700752236	19-50	7700755645	55-02	7700759441	86-20
7700726566	12-18	77007336437	21-65	7700752366	55-02	7700755657	31-40	7700759606	42-10
7700726567	12-18	77007336438	21-65	7700752366	55-02	7700755672	62-35	7700759740	86-01
7700726615	13-20	77007336439	21-45	7700752432	55-20	7700755673	62-35	7700759744	86-01
7700726816	13-30	77007337244	21-60	7700752432	19-80	7700755670	50-25	7700759744	72-15
7700727170	17-12	7700737467	21-20	7700752432	19-80	7700756702	50-25	7700759872	33-60
7700727306	21-30	7700737559	21-30	7700752564	80-30	7700756733	80-01	7700759877	64-01
7700727306	21-45	7700737559	21-30	7700752565	84-10	7700756798	42-10	7700759987	31-40
7700727482	10-70	7700737560	20-01	7700752565	64-01	7700756928	65-01	7700760264	32-10
7700727482	10-70	7700737563	21-65	7700752671	19-50	7700757085	19-50	7700760361	75-01
7700727684	10-70	7700743722	21-65	7700752707	19-50				

1	2	1	2	1	2	1	2	1	2	1	2
7700760452	32-10	7700764267	36-10	7700774836	42-10	7701022156	12-22	7701027053	60-25		
7700760465	36-12	7700764328	56-20	7700776347	36-30	7701022446	83-05	7701027088	85-03		
7700760467	36-12	7700764523	13-81	7700776348	36-30	7701022969	83-01	7701027089	85-03		
7700760488	19-80	7700765058	33-01	7700776558	56-21	7701022969	83-05	7701027090	85-03		
7700760510	19-80	7700765059	33-01	7700778001	61-201	7701023144	50-15	7701027099	32-35		
7700760571	32-01	7700765061	33-01	7700778012	33-01	7701023144	50-15	7701027100	32-35		
7700760825	84-01	7700765071	33-01	7700778013	33-01	7701023199	50-15	7701027196	85-10		
7700760828	83-10	7700765072	33-01	7700779192	83-08	7701023199	50-15	7701027367	34-30		
7700760898	65-01	7700765076	13-31	7700780173	83-01	7701023200	50-25	7701027368	34-30		
7700760899	65-01	7700765122	19-50	7700794652	83-08	7701023200	50-25	7701027491	17-11		
7700760973	46-10	7700765124	19-60	7700794653	83-08	7701023206	50-15	7701027537	12-20		
7700761474	55-25	7700765254	58-30	7700794654	83-08	7701023206	50-25	7701027538	12-20		
7700761475	55-25	7700765256	58-30	7701000954	59-20	7701023207	50-15	7701027559	12-24		
7700761476	55-25	7700765728	84-20	7701000954	59-50	7701023207	50-25	7701027569	12-20		
7700761477	55-25	7700765728	84-20	7701000955	59-20	7701023480	12-32	7701027574	12-22		
7700761525	76-01	7700765844	84-30	7701000955	59-50	7701023914	12-22	7701027574	12-20		
7700761526	76-01	7700765910	57-01	7701000957	59-50	7701024222	12-20	7701027581	12-20		
7700761526	76-02	7700765937	83-10	7701002851	12-22	7701024265	34-40	7701027608	50-54		
7700762050	19-50	7700766422	36-10	7701005301	12-20	7701024266	34-40	7701027609	50-54		
7700762380	37-30	7700766485	19-50	7701005315	12-24	7701024838	83-05	7701027743	12-12		
7700762432	19-80	7700766486	19-50	7701012548	83-01	7701025323	83-05	7701027842	12-13		
7700762475	29-01	7700766661	61-20	7701012548	83-05	7701025324	83-05	7701027870	17-11		
7700762481	61-01	7700766681	19-50	7701013522	12-12	7701025325	83-05	7701027960	85-15		
7700762572	61-01	7700766681	19-50	7701013646	85-15	7701025326	83-05	7701027961	85-15		
7700762573	32-10	7700767163	55-40	7701014582	12-24	7701025327	83-05	7701027962	85-06		
7700762856	19-80	7700767164	55-40	7701016137	12-12	7701025329	83-05	7701027963	85-06		
7700762856	36-12	7700767620	87-40	7701017580	12-33	7701025330	83-05	7701027964	85-06		
7700762857	36-12	7700768048	57-01	7701018211	85-15	7701025331	83-05	7701027967	85-06		
7700762857	36-10	7700768061	37-30	7701018447	50-10	7701025333	83-05	7701027968	85-06		
7700762857	36-12	7700768332	61-201	7701018447	50-20	7701025334	83-05	7701027969	85-06		
7700762858	36-10	7700768551	87-40	7701018638	12-22	7701025356	83-05	7701027993	12-11		
7700762859	36-10	7700768945	36-30	7701018638	12-22	7701025358	83-05	7701027994	12-11		
7700762960	19-04	7700769760	53-01	7701018691	29-01	7701026372	12-22	7701027998	12-13		
7700763302	75-10	7700769862	36-30	7701018981	29-01	7701026390	12-13	7701027999	12-13		
7700763387	79-01	7700770996	36-30	7701019117	12-12	7701026390	12-33	7701027999	12-131		
7700763387	79-02	7700771149	83-10	7701019117	12-22	7701026390	85-10	7701028002	12-11		
7700763387	79-031	7700771191	56-01	7701020166	12-32	7701026736	85-10	7701028002	12-31		
7700763387	79-031	7700771347	83-06	7701020532	37-40	7701026789	85-10	7701028004	12-13		
7700763502	79-02	7700771720	13-03	7701020533	12-22	7701026803	85-10	7701028220	62-30		
7700763502	79-031	7700771721	87-40	7701020611	12-12	7701026859	17-12	7701028238	85-15		
7700763871	52-01	7700771793	61-20	7701020611	12-121	7701026890	64-01	7701028239	85-10		
7700763877	57-01	7700771925	50-01	7701021352	12-24	7701026892	64-01	7701028247	34-32		
7700763878	57-01	7700772878	36-10	7701021352	50-15	7701026984	64-01	7701028248	34-32		
7700763881	57-01	7700773259	31-01	7701021352	50-15	7701027039	60-20	7701028382	60-20		
7700763882	57-01	7700773311	36-10	7701021253	50-25	7701027040	60-20	7701028383	60-20		
7700763919	48-01	7700773796	83-08	7701021253	85-15	7701027044	60-20	7701028384	60-20		
7700764215	12-11	7700774566	36-10	7701021321	12-32	7701027046	60-20	7701028385	60-20		
		7700774647	64-01	7701021947	19-11	7701027052	60-25	7701028457	75-10		
				7701021983	17-11	7701027052	60-251	7701028457	75-15		

1	2	1	2	1	2	1	2	1	2
77010288458	75-10	77010297411	83-06	7701200805	17-11	7701348166	50-15	7701349364	10-50
77010288458	75-15	77010297416	83-06	7701200831	12-12	7701348166	50-20	7701349369	84-20
77010286855	60-20	7701029814	60-20	7701200831	12-32	7701348166	50-25	7701349370	84-20
7701029053	81-10	7701029815	60-20	7701201025	85-03	7701348167	50-10	7701349408	84-20
7701029054	81-10	7701029835	83-06	7701201025	85-06	7701348167	50-15	7701349413	87-52
7701029055	81-10	7701029838	83-06	7701201025	34-40	7701348167	50-20	7701349417	84-01
7701029056	81-10	7701029839	83-06	7701201556	12-34	7701348168	50-10	7701349457	52-01
7701029201	62-30	7701030200	60-20	7701201557	12-34	7701348168	50-15	7701349462	53-01
7701029211	53-01	7701030250	62-30	7701201558	12-34	7701348168	50-20	7701349463	53-01
7701029240	60-20	7701030263	12-20	7701201559	12-32	7701348178	10-40	7701349465	81-40
7701029241	60-20	7701030450	12-32	7701201628	85-10	7701348190	86-20	7701349472	84-01
7701029242	60-20	7701030630	12-20	7701201636	85-10	7701348194	86-20	7701349500	81-40
7701029243	60-20	7701030669	12-12	7701201661	60-25	7701348415	10-30	7701349507	53-01
7701029244	60-20	7701030669	12-121	7701201662	85-03	7701348416	10-30	7701349510	50-55
7701029248	60-20	7701030705	12-18	7701201680	34-40	7701348419	10-30	7701349511	50-55
7701029249	60-20	7701030706	12-20	7701201687	34-30	7701348422	10-30	7701349530	13-20
7701029250	60-20	7701030707	12-24	7701201688	34-30	7701348568	29-01	7701349555	50-01
7701029253	50-10	7701030711	12-20	7701201689	34-30	7701348570	83-01	7701349558	52-20
7701029254	50-10	7701030712	12-20	7701201751	85-15	7701348570	83-05	7701349575	50-54
7701029254	50-10	7701030717	12-20	7701201752	12-14	7701348570	83-06	7701349576	50-54
7701029254	50-20	7701030721	12-24	7701201753	12-14	7701348673	32-30	7701349597	66-01
7701029257	50-10	7701030838	12-24	7701201754	12-14	7701348673	32-34	7701349598	66-01
7701029258	50-10	7701030845	12-22	7701201775	32-35	7701348673	32-35	7701349599	66-01
7701029258	50-20	7701030846	12-24	7701201823	34-32	7701348673	34-40	7701349600	66-01
7701029259	50-15	7701030847	12-24	7701201824	34-32	7701348674	34-40	7701349602	81-01
7701029259	50-25	7701030848	12-24	7701201825	34-32	7701348716	86-20	7701349604	13-20
7701029260	50-15	7701030849	12-24	7701201828	36-12	7701348718	86-20	7701349607	56-20
7701029260	50-25	7701030850	12-26	7701201837	13-85	7701348750	86-30	7701349617	84-20
7701029281	80-40	7701030851	12-26	7701201853	60-20	7701348860	86-30	7701349623	84-20
7701029282	80-40	7701030852	12-18	7701201855	60-20	77013488914	20-01	7701349624	87-40
7701029285	50-15	7701030853	12-20	7701201899	62-30	77013488974	36-30	7701349632	13-20
7701029285	50-25	7701030860	12-20	7701202003	60-20	77013488974	81-40	7701349637	53-01
7701029288	50-15	7701030895	12-33	7701202004	37-60	7701349041	84-30	7701349642	79-01
7701029288	50-15	7701031064	83-06	7701202012	60-20	7701349098	11-40	7701349648	34-32
7701029290	50-25	7701031090	52-20	7701202036	74-01	7701349123	34-40	7701349649	29-01
7701029291	50-25	7701031113	12-32	7701202051	74-01	7701349123	34-40	7701349660	34-30
7701029308	60-25	7701031135	17-12	7701202052	74-01	7701349266	13-01	7701349700	29-01
7701029309	81-10	7701031182	12-33	7701202052	55-25	7701349269	11-01	7701349704	10-50
7701029310	81-10	7701031183	12-33	7701202232	55-25	7701349278	11-01	7701349704	53-01
7701029311	81-10	7701031184	12-33	7701202285	32-35	7701349278	86-20	7701349728	81-40
7701029312	81-10	7701031187	12-32	7701202350	29-01	7701349285	86-10	7701349729	81-40
7701029446	53-01	7701031390	60-20	7701202428	13-90	7701349306	37-70	7701349789	81-40
7701029447	12-20	7701031443	62-30	7701202428	55-02	7701349314	11-01	7701349817	60-20
7701029454	62-30	7701031741	60-20	7701202809	55-02	7701349318	84-01	7701349831	81-40
7701029574	12-12	7701031974	12-31	7701348115	13-24	7701349319	84-01	7701349904	81-40
7701029664	12-32	7701032105	12-31	7701348165	50-10	7701349352	75-15	7701349925	56-21
7701029664	60-20	7701032113	12-22	7701348165	50-15	7701349352	75-15	7701349951	81-40
7701029724	12-32	7701033227	13-04	7701348165	50-20	7701349353	75-15	7701349955	81-40
7701029725	12-32	7701034109	60-20	7701348165	50-25	7701349356	81-40	7701407310	81-40
7701029726	12-31	7701073836	19-01	7701348166	50-10	7701349359	29-01	7701407311	17-11

1	2	1	2	1	2	1	2	1	2
7701460923	11-20	7701463723	33-01	7701986709	88-02	7702025192	76-02	770206826	59-50
7701461412	36-10	7701463888	21-20	7701986709	88-03	7702027226	21-20	7702061760	86-30
7701461605	43-01	7701464006	36-30	7701986709	88-04	7702027748	17-10	7702061771	86-30
7701461606	43-01	7701464111	38-20	7701986709	88-041	7702027749	17-10	7702061773	81-40
7701461607	43-01	7701464163	38-20	7701986709	88-042	7702027755	17-10	7702061984	87-50
7701461608	43-01	7701464164	38-20	7701986768	88-02	7702027870	16-05	7702061984	16-05
7701461609	43-01	7701464321	33-01	7701986780	88-02	7702052142	10-30	7702069928	16-05
7701461610	43-01	7701465268	11-20	7701986781	88-02	7702052143	10-30	7702069929	16-05
7701461611	43-01	7701493033	21-20	7701986806	88-02	7702052342	10-60	7702069932	16-05
7701461612	43-01	7701586652	43-01	7701986806	88-04	7702052908	17-10	7702069935	16-05
7701461616	43-01	7701586653	43-01	7701986806	88-042	7702053106	17-10	7702069970	17-15
7701461617	43-01	7701588187	10-70	7701986813	88-02	7702054601	19-10	7702069971	17-15
7701462100	29-01	7701588241	13-85	7701986818	88-02	7702054628	90-01	7702069972	17-15
7701462101	29-01	7701589774	43-01	7701986818	88-03	7702054803	19-40	7702069973	17-15
7701462145	11-01	7701589775	43-01	7701986818	88-04	7702054899	36-30	7702069974	17-15
7701462168	36-01	7701589782	44-01	7701986998	83-10	7702056084	12-01	7702069976	17-15
7701462217	33-40	7701589783	44-01	7701988094	88-05	7702056084	12-02	7702070005	17-15
7701462293	21-40	7701589786	44-01	7701988045	87-30	7702056319	10-40	7702070007	17-15
7701462293	21-45	7701589787	44-01	7701988052	81-50	7702056384	10-60	7702070009	17-15
7701462293	21-45	7701590365	42-10	7701988053	81-50	7702056691	19-20	7702070010	17-15
7701462325	21-45	7701590366	42-10	7701988054	81-50	7702056692	12-50	7702070140	10-30
7701462326	21-45	7701590374	42-01	7701988056	81-50	7702056693	12-50	7702070141	10-30
7701462328	21-40	7701592739	42-01	7701988057	81-50	7702056975	12-50	7702070142	10-30
7701462328	21-45	7701596824	85-18	7701988058	81-50	7702057041	13-80	7702070165	10-30
7701462469	31-40	7701596841	61-20	7701988059	81-50	7702057095	10-60	7702070166	10-30
7701462512	33-01	7701598769	42-01	7701988065	81-50	7702057211	10-50	7702070167	10-30
7701462573	11-40	7701600233	57-01	7702020177	12-15	7702057212	10-50	7702070168	10-30
7701462576	21-40	7701601740	55-02	7702021098	11-40	7702057213	11-30	7702070169	10-30
7701462576	21-45	7701610952	43-01	7702021729	17-10	7702057273	11-30	7702070195	10-10
7701462587	41-30	7701611384	11-01	7702021730	17-10	7702057727	10-60	7702070200	10-70
7701462865	55-01	7701612276	43-01	7702021731	17-10	7702057732	11-30	7702070221	32-35
7701462872	48-01	7701613248	57-01	7702021731	17-10	7702057894	13-01	7702070229	10-20
7701462882	48-01	7701613345	55-10	7702021738	17-10	7702057895	10-40	7702070265	17-10
7701462952	48-01	7701613348	55-10	7702023292	13-01	7702057895	13-01	7702070266	17-10
7701463001	55-01	7701613474	58-30	7702023315	10-60	7702057955	10-60	7702070269	10-20
7701463001	55-02	7701623894	10-70	7702023315	10-60	7702058744	20-01	7702071193	59-51
7701463002	48-01	7701635029	10-70	7702023315	10-60	7702058879	20-01	7702071350	59-50
7701463003	48-01	7701638463	29-01	7702023317	11-40	7702058893	21-01	7702071350	59-50
7701463086	55-01	7701642468	13-01	7702023365	11-40	7702058895	21-01	7702071788	58-20
7701463181	11-40	7701985977	88-02	7702023366	11-40	7702058905	20-01	7702071811	86-30
7701463194	29-01	7701985977	88-03	7702023366	11-40	7702058941	21-20	7702071838	58-20
7701463223	21-65	7701985977	88-04	77020233587	11-40	7702058949	21-01	7702072030	81-20
7701463224	44-01	7701985977	88-041	77020233589	11-40	7702058951	20-01	7702072031	87-40
7701463225	44-01	7701985977	88-042	77020233904	10-60	7702060784	21-20	7702072065	81-40
7701463265	21-30	7701985977	88-05	77020233929	10-60	7702060784	59-20	7702072080	87-40
7701463377	11-01	7701985977	88-051	77020233930	10-60	7702060784	59-50	7702072095	86-30
7701463500	21-20	7701986268	88-02	77020233933	10-60	7702060786	59-20	7702072100	86-30
7701463523	33-40	7701986268	88-03	77020233936	17-05	7702060786	59-20	7702072110	86-30
7701463586	29-01	7701986406	88-02	77020235817	61-01	7702060787	59-20	7702072115	87-40
77014635651	21-30	77019866406	88-03	7702026192	44-20	7702060826	59-20	7702072268	85-03

1	2	1	2	1	2	1	2	1	2
7702072268	85-06	77020733882	32-01	7702073750	42-01	77020738840	32-34	77020739808	37-60
7702072365	10-70	77020733884	34-01	7702073751	44-20	77020738843	32-30	77020739909	83-05
7702072379	80-25	77020733888	34-01	7702073752	48-01	77020738845	32-30	77020739911	83-05
7702072451	87-40	77020733889	42-01	7702073753	46-01	77020738845	32-30	77020739912	83-01
7702072530	87-52	77020733890	41-10	7702073754	46-01	77020738845	32-34	77020739913	83-01
7702072545	87-52	77020733891	41-10	7702073757	86-30	77020738846	32-35	77020739914	83-01
7702072708	86-20	77020733892	41-10	7702073769	40-10	77020738847	32-34	77020739915	83-01
7702072738	62-35	77020733893	41-10	7702073771	40-10	77020738848	32-30	77020739916	83-01
7702072739	61-20 ¹	77020733894	41-10	7702073774	40-10	77020738849	32-30	77020739917	83-01
7702072746	86-30	77020733894	41-10	7702073775	17-15				
7702072762	88-03	77020733895	41-10	7702073776	17-15	77020738850	32-30	77020739918	37-60
7702072852	87-40	77020733896	41-10	7702073787	80-20	77020738851	32-30	77020739919	37-40
7702072885	87-40	77020733897	41-10	7702073788	80-20	77020738852	32-30	77020739920	37-40
7702072894	80-25	77020733898	41-10	7702073789	80-20	77020738853	32-30	77020739921	37-40
7702072895	87-40	77020733899	41-10	7702073790	80-20	77020738854	32-30	77020739922	37-60
7702072896	87-40	77020733900	41-10	7702073791	80-20	77020738855	32-34	77020739923	17-10
7702072898	87-40	77020733901	41-30	7702073792	80-20	77020738856	32-34	77020739924	17-10
7702072906	87-40	77020733902	41-30	7702073793	80-20	77020738857	32-34	77020739925	17-10
7702072932	87-40	77020733903	41-30	7702073794	88-02	77020738858	32-34	77020739926	83-01
7702072944	81-40	77020733904	41-30	7702073794	88-03	77020738859	32-34	77020739927	37-40
7702072947	81-40	77020733907	41-30	7702073794	88-04	77020738859	32-35	77020739928	37-40
7702072956	86-30	77020733921	80-25	7702073794	88-041	77020738860	32-34	77020739949	17-10
7702072958	84-10	77020733926	41-20	7702073794	88-05	77020738861	11-20	77020739953	16-70
7702073024	12-22	77020733927	41-20	7702073795	88-051	77020738864	42-10	77020739955	16-70
7702073099	13-01	77020733927	84-30	7702073795	88-02	77020738876	16-15	77020739955	16-70
7702073147	19-40	77020733927	84-30	7702073795	88-02	77020738877	16-15	77020739956	16-70
7702073165	34-01	77020733927	11-20	7702073795	88-03	77020738878	16-15	77020739957	16-70
7702073205	16-05	77020733927	42-10	7702073795	88-04	77020738879	16-15	77020739958	16-70
7702073206	16-05	77020733948	42-10	7702073795	88-041	77020738880	16-15	77020739959	16-70
7702073207	16-05	77020733948	41-20	7702073795	88-042	77020738881	16-15	77020739960	16-70
7702073208	16-05	77020733948	41-20	7702073795	88-05	77020738882	16-15	77020739961	16-70
7702073212	16-05	77020733951	32-35	7702073795	88-051	77020738883	16-15	77020739962	16-70
7702073214	16-05	77020733956	41-30	7702073796	80-20	77020738884	16-15	77020739963	16-15
7702073216	16-05	77020733957	41-30	7702073796	16-05	77020738885	16-15	77020739963	16-70
7702073218	16-05	77020733958	41-30	7702073804	16-05	77020738886	16-15	77020739965	16-70
7702073220	16-05	77020733959	41-30	7702073805	16-05	77020738887	16-15	77020739965	16-70
7702073221	16-05	77020733960	41-30	7702073815	31-30	77020738888	16-15	77020739967	16-70
7702073224	16-05	77020733960	84-10	7702073828	12-11	77020738888	16-15	77020739967	16-70
7702073227	16-05	77020733968	40-01	7702073828	12-12	77020738890	16-15	77020739969	16-70
7702073235	85-12	77020733969	34-01	7702073830	12-12	77020738892	16-15	77020739970	16-70
7702073236	85-12	77020733970	10-10	7702073831	12-11	77020738893	16-15	77020739971	16-70
7702073237	85-12	77020733970	10-20	7702073831	12-11	77020738894	16-15	77020739972	16-70
7702073243	85-03	77020733971	10-30	7702073832	12-12	77020738895	16-15	77020739973	16-70
7702073249	37-60	77020733972	41-40	7702073833	12-12	77020738896	16-15	77020739974	16-70
7702073259	85-12	77020733973	83-05	7702073833	12-12	77020738897	16-15	77020739975	16-70
7702073272	16-12	77020733974	42-10	7702073833	12-12	77020738897	37-40	77020739975	16-70
7702073275	11-20	77020733975	42-10	7702073834	12-12	77020738897	37-40	77020739976	16-70
7702073285	42-01	77020733976	82-01	7702073834	19-01	77020738897	37-40	77020739977	16-70
7702073286	42-01	77020733977	45-01	7702073835	19-01	77020738897	37-40	77020739978	16-70
7702073366	42-01	77020733978	45-01	7702073835	19-01	77020738897	37-40	77020739978	16-70
7702073386	42-01	77020733979	45-01	7702073836	19-01	77020738897	37-40	77020739979	16-70

1	2	1	2	1	2	1	2	1	2
7702073980	16-70	7702080759	12-55	7702080955	37-60	7702081505	57-01	7702081780	57-01
7702073981	16-70	7702080762	12-02	7702080959	41-30	7702081506	57-01	7702081781	57-01
7702073984	16-15	7702080763	12-02	7702080963	46-10	7702081513	57-01	7702081786	84-01
7702073987	13-01	7702080764	12-31	7702080983	41-10	7702081514	57-01	7702081826	57-01
7702073999	16-15	7702080765	12-33	7702081007	19-60	7702081515	57-01	7702081830	58-40
7702074013	44-01	7702080766	12-55	7702081014	36-30	7702081516	57-01	7702081831	58-30
7702074025	76-02	7702080777	13-80	7702081026	19-20	7702081529	55-10	7702081834	57-01
7702074034	10-60	7702080778	13-85	7702081027	19-20	7702081539	52-20	7702081835	57-01
7702074035	11-20	7702080779	13-85	7702081036	19-40	7702081545	55-01	7702081840	65-01
7702074047	13-04	7702080783	13-85	7702081038	36-30	7702081562	50-65	7702082001	69-01
7702074081	31-01	7702080784	13-85	7702081044	38-01	7702081563	50-65	7702082005	58-40
7702078806	59-20	7702080785	13-80	7702081045	19-30	7702081564	50-60	7702082006	58-40
7702079333	59-20	7702080786	13-80	7702081048	19-30	7702081565	50-60	7702082007	58-40
7702080611	11-20	7702080789	10-60	7702081050	19-20	7702081572	50-60	7702082008	58-40
7702080612	12-01	7702080796	10-50	7702081054	36-30	7702081572	50-65	7702082009	72-01
7702080617	11-01	7702080798	10-60	7702081058	19-50	7702081582	55-20	7702082010	72-01
7702080626	10-01	7702080803	10-50	7702081059	19-50	7702081583	55-20	7702082011	72-01
7702080632	12-15	7702080804	10-50	7702081061	19-50	7702081584	55-20	7702082012	72-01
7702080634	10-01	7702080821	17-20	7702081071	31-01	7702081592	56-35	7702082015	72-03
7702080636	10-01	7702080824	13-85	7702081072	31-01	7702081593	56-35	7702082016	72-03
7702080637	13-85	7702080828	17-20	7702081075	31-01	7702081594	55-20	7702082017	72-03
7702080639	13-85	7702080838	10-70	7702081076	31-01	7702081595	55-20	7702082018	72-03
7702080640	13-85	7702080844	10-70	7702081077	31-30	7702081618	50-60	7702082029	72-01
7702080649	10-50	7702080845	10-70	7702081092	31-01	7702081619	50-60	7702082030	72-01
7702080654	11-01	7702080846	10-50	7702081093	31-01	7702081620	50-60	7702082031	72-01
7702080667	16-01	7702080848	10-60	7702081409	65-01	7702081645	57-01	7702082032	72-01
7702080678	11-40	7702080849	10-60	7702081410	52-01	7702081646	57-01	7702082035	72-03
7702080679	10-60	7702080850	10-60	7702081424	50-40	7702081672	55-20	7702082036	72-03
7702080681	10-60	7702080856	11-40	7702081424	50-50	7702081673	55-20	7702082037	72-03
7702080682	10-60	7702080866	10-01	7702081425	50-40	7702081683	52-20	7702082038	72-03
7702080683	13-28	7702080867	10-01	7702081425	50-50	7702081689	59-20	7702082066	81-40
7702080684	13-30	7702080877	10-60	7702081434	59-20	7702081693	58-30	7702082107	72-15
7702080689	13-01	7702080879	10-60	7702081439	42-01	7702081700	64-01	7702082108	72-15
7702080689	19-40	7702080880	10-70	7702081446	59-50	7702081707	65-01	7702082109	72-15
7702080691	10-60	7702080889	10-70	7702081448	59-50	7702081708	65-01	7702082110	72-15
7702080693	19-40	7702080911	11-40	7702081472	64-01	7702081711	55-20	7702082151	69-01
7702080694	13-01	7702080912	19-01	7702081477	59-20	7702081712	55-20	7702082152	77-10
7702080695	13-01	7702080913	19-01	7702081478	59-20	7702081713	55-20	7702082153	77-10
7702080696	13-01	7702080914	37-50	7702081483	59-20	7702081714	55-20	7702082154	77-10
7702080697	13-01	7702080915	37-50	7702081484	58-30	7702081715	55-20	7702082155	77-10
7702080710	10-50	7702080927	37-70	7702081485	58-30	7702081716	55-20	7702082156	77-10
7702080728	10-01	7702080928	19-30	7702081486	58-30	7702081717	55-20	7702082157	77-10
7702080729	10-70	7702080935	19-30	7702081487	56-01	7702081718	55-20	7702082158	77-10
7702080732	13-42	7702080939	38-01	7702081488	57-01	7702081720	55-20	7702082159	77-10
7702080735	19-41	7702080936	37-80	7702081489	57-01	7702081735	58-30	7702082164	78-11
7702080740	12-18	7702080937	37-80	7702081490	57-01	7702081745	59-51	7702082165	78-11
7702080745	12-18	7702080946	46-10	7702081491	57-01	7702081746	59-51	7702082166	78-11
7702080746	12-11	7702080947	46-10	7702081492	57-01	7702081769	65-01	7702082167	78-11
7702080753	16-01	7702080953	37-60	7702081503	57-01	7702081778	57-01	7702082168	78-11
7702080758	12-55	7702080954	37-60	7702081504	57-01	7702081779	57-01	7702082169	78-11

indice numerico

1	2	1	2	1	2	1	2		
7702082170	78-11	7702082555	17-05	7702082657	88-05	7702082761	88-03	7702082866	62-351
7702082172	79-01	7702082564	85-18	7702082659	88-051	7702082761	88-04	7702082867	62-351
7702082173	79-01	7702082565	85-06	7702082661	88-051	7702082761	88-042	7702082868	62-351
7702082190	79-01	7702082565	85-18	7702082662	88-051	7702082762	88-04	7702082870	62-351
7702082191	79-01	7702082567	81-10	7702082663	88-051	7702082762	88-041	7702082871	62-351
7702082208	71-01	7702082568	81-10	7702082663	88-03	7702082762	88-042	7702082872	62-351
7702082209	71-01	7702082569	81-40	7702082663	88-05	7702082763	88-03	7702082876	62-351
7702082210	71-01	7702082570	81-40	7702082663	88-051	7702082764	88-03	7702082877	88-041
7702082211	71-01	7702082571	81-40	7702082664	88-05	7702082765	88-03	7702082877	88-042
7702082214	72-15	7702082572	81-40	7702082665	88-05	7702082766	88-04	7702083149	19-40
7702082215	72-15	7702082573	87-40	7702082666	88-05	7702082766	88-041	7702083280	37-60
7702082216	72-15	7702082574	81-40	7702082666	88-051	7702082766	88-042	7702083325	42-01
7702082217	72-15	7702082575	87-50	7702082668	88-05	7702082767	88-04	7702083326	42-01
7702082230	77-10	7702082576	87-50	7702082669	88-051	7702082767	88-041	7702083356	42-10
7702082231	77-10	7702082578	88-02	7702082670	88-051	7702082767	88-042	7702083557	42-10
7702082232	77-10	7702082578	88-02	7702082671	88-25	7702082768	88-03	7702083557	19-40
7702082233	77-10	7702082580	88-02	7702082673	86-30	7702082769	88-04	7702085057	19-40
7702082236	78-10	7702082581	88-02	7702082673	86-20	7702082769	88-04	7702085058	19-40
7702082237	78-10	7702082582	88-03	7702082676	88-02	7702082777	88-05	7702085058	61-20
7702082240	78-10	7702082583	88-02	7702082683	88-03	7702082777	88-051	7702085088	37-20
7702082241	78-10	7702082583	88-03	7702082683	88-04	7702082789	82-01	7702085190	19-40
7702082242	71-05	7702082583	88-05	7702082684	88-05	7702082790	82-01	7702085191	19-40
7702082255	78-11	7702082584	88-02	7702082699	88-05	7702082809	88-041	7702085192	19-40
7702082256	78-11	7702082590	83-01	7702082700	88-03	7702082809	88-042	7702085207	19-40
7702082257	78-11	7702082591	83-05	7702082700	88-04	7702082819	88-051	7702085209	61-20
7702082259	78-11	7702082596	88-02	7702082701	84-01	7702082821	88-051	7702085209	37-20
7702082259	78-11	7702082596	19-01	7702082701	88-03	7702082822	88-041	7702085280	19-01
7702082260	78-11	7702082615	17-10	7702082710	88-03	7702082822	88-042	7702085336	19-01
7702082261	78-11	7702082617	17-10	7702082711	88-03	7702082822	88-042	7702085343	36-40
7702082262	78-11	7702082618	17-05	7702082712	88-03	7702082825	88-042	7702085384	36-30
7702082264	71-05	7702082621	17-05	7702082723	88-05	7702082825	88-042	7702085384	46-10
7702082264	16-01	7702082624	61-20	7702082724	88-05	7702082826	88-041	7702085389	19-41
7702082265	16-01	7702082626	61-20	7702082725	87-40	7702082826	88-042	7702085392	41-30
7702082266	16-70	7702082626	61-20	7702082726	88-03	7702082828	88-051	7702085393	41-30
7702082267	82-01	7702082627	61-20	7702082726	88-042	7702082828	88-051	7702085401	38-01
7702082268	82-01	7702082628	61-20	7702082730	88-03	7702082836	88-051	7702085401	38-01
7702082268	84-30	7702082629	83-02	7702082735	80-25	7702082837	88-051	7702085402	41-30
7702082269	19-10	7702082630	87-52	7702082736	83-10	7702082838	88-051	7702085402	19-20
7702082269	19-10	7702082630	17-05	7702082736	83-10	7702082838	88-051	7702085430	19-20
7702082269	16-05	7702082633	88-02	7702082737	62-35	7702082840	88-042	7702085430	37-60
7702082269	16-05	7702082640	88-02	7702082743	62-35	7702082843	17-05	7702085433	37-60
7702082269	16-05	7702082647	87-40	7702082744	62-35	7702082845	17-10	7702085442	19-20
7702082269	16-01	7702082649	85-03	7702082746	83-05	7702082850	88-042	7702085443	19-20
7702082269	16-15	7702082649	85-06	7702082756	17-05	7702082857	16-15	7702085445	19-20
7702082269	16-01	7702082652	88-05	7702082757	61-01	7702082858	16-15	7702085458	19-01
7702082269	16-15	7702082653	88-05	7702082758	88-03	7702082859	62-351	7702085459	19-01
7702082269	13-85	7702082653	88-051	7702082758	88-04	7702082860	62-351	7702085459	11-30
7702082269	85-03	7702082654	88-05	7702082758	88-04	7702082860	62-351	7702085459	11-30
7702082269	85-06	7702082654	88-051	7702082759	88-03	7702082862	62-351	7702085460	12-01
7702082269	86-01	7702082655	88-05	7702082759	88-04	7702082862	62-351	7702085462	19-40
7702082269	17-15	7702082656	88-051	7702082759	88-042	7702082863	62-351	7702085462	19-40
7702082269	17-15	7702082656	88-051	7702082760	88-03	7702082864	62-351	7702085463	11-30

1	2	1	2	1	2	1	2	1	2
7702088573	42-10	7702088755	59-20	7702089451	32-35	7702092817	78-11	7702093763	32-01
7702088574	17-20	7702088756	59-20	7702089487	17-20	7702092818	78-11	7702093836	35-01
7702088578	43-01	7702088792	59-20	7702089496	44-01	7702092819	78-11	7702093837	35-01
7702088589	43-01	7702088852	19-30	7702089497	44-01	7702092820	78-11	7702093841	33-40
7702088590	80-20	7702088877	83-06	7702089498	44-01	7702092821	78-10	7702093860	13-81
7702088591	12-22	7702088878	83-06	7702089501	41-10	7702092822	78-11	7702093864	13-81
7702088594	13-20	7702088879	83-06	7702089506	60-20	7702092823	78-11	7702093865	13-80
7702088595	11-20	7702088880	83-06	7702089518	13-85	7702092824	78-11	7702093869	36-30
7702088619	60-20	7702088881	81-10	7702089519	13-85	7702092825	78-11	7702093878	13-81
7702088626	80-40	7702088882	81-10	7702089520	13-85	7702092826	78-11	7702093878	13-80
7702088627	80-40	7702088888	10-70	7702089522	10-70	7702092827	78-10	7702093951	31-01
7702088629	17-10	7702088890	59-50	7702089542	10-10	7702092828	78-10	7702094099	31-01
7702088630	17-10	7702088891	59-50	7702089543	10-10	7702092829	72-01	7702094101	41-10
7702088639	19-30	7702088920	11-20	7702089549	86-30	7702092830	72-01	7702094184	35-01
7702088666	11-20	7702089204	11-20	7702089829	12-15	7702092831	72-01	7702094185	35-01
7702088723	16-70	7702089205	11-20	7702090665	72-03	7702092832	72-01	7702094186	35-01
7702088731	10-20	7702089206	11-20	7702090666	72-03	7702092833	72-01	7702094187	35-01
7702088732	10-20	7702089212	85-03	7702090667	72-03	7702092834	72-01	7702094189	35-01
7702088733	10-20	7702089213	85-03	7702090668	72-03	7702092835	72-01	7702094191	35-01
7702088734	10-20	7702089214	85-12	7702090859	78-12	7702092836	72-01	7702094193	35-01
7702088735	16-70	7702089215	85-03	7702090860	78-12	7702092885	72-03	7702094325	19-01
7702088740	60-20	7702089216	85-03	7702090861	78-12	7702092886	72-03	7702094403	31-01
7702088741	60-22	7702089218	37-40	7702090862	78-12	7702092887	72-03	7702094429	36-12
7702088742	60-22	7702089221	43-01	7702090870	77-06	7702092888	72-03	7702094447	38-20
7702088743	60-20	7702089222	43-01	7702090875	77-06	7702092889	72-03	7702095758	77-06
7702088744	60-22	7702089226	43-01	7702090876	77-06	7702092890	72-03	7702095759	77-06
7702088743	60-22	7702089229	43-01	7702090905	79-02	7702092891	72-03	7702095760	77-06
7702088743	60-22	7702089232	43-01	7702090906	79-02	7702092892	72-01	7702095761	77-06
7702088744	60-20	7702089235	43-01	7702090959	78-10	7702092894	72-01	7702095761	77-06
7702088744	60-20	7702089238	43-01	7702090960	78-10	7702092895	72-01	7702095762	78-12
7702088744	60-20	7702089241	43-01	7702090963	72-03	7702092896	72-01	7702095763	78-12
7702088745	60-20	7702089244	43-01	7702090964	72-03	7702092897	79-01	7702095764	78-12
7702088745	60-20	7702089251	43-01	7702090993	72-03	7702092898	79-01	7702095765	78-12
7702088746	60-20	7702089252	43-01	7702090994	72-03	7702093513	19-01	7702095766	79-02
7702088746	60-20	7702089263	42-01	7702091013	72-03	7702093514	10-80	7702095955	79-03
7702088746	60-20	7702089305	59-50	7702091014	59-20	7702093522	37-01	7702096006	29-01
7702088746	60-22	7702089306	58-30	7702091110	59-51	7702093567	19-50	7702096009	21-20
7702088747	60-22	7702089315	85-03	7702091954	56-01	7702093580	31-01	7702096013	20-01
7702088748	60-22	7702089315	85-06	7702092788	74-01	7702093830	37-70	7702096013	21-20
7702088749	60-20	7702089325	80-25	7702092789	74-01	7702093833	36-01	7702096113	21-01
7702088749	60-22	7702089326	80-25	7702092792	69-01	7702093866	36-10	7702097153	36-01
7702088750	60-20	7702089331	13-81	7702092793	69-01	7702093867	36-10	7702097548	71-05
7702088750	60-22	7702089332	13-80	7702092794	69-01	7702093868	36-10	7702097782	58-40
7702088751	60-22	7702089333	13-80	7702092809	77-10	7702093869	36-10	7702099278	62-35
7702088751	60-22	7702089335	13-81	7702092810	77-10	7702093870	36-10	7702108809	50-70
7702088752	60-20	7702089336	13-81	7702092811	77-10	7702093871	36-10	7702111932	32-10
7702088752	60-22	7702089341	83-05	7702092812	77-10	7702093872	36-10	7702111933	32-10
7702088753	59-20	7702089420	84-30	7702092813	77-10	7702093873	36-10	7702112065	11-40
7702088754	59-20	7702089450	32-35	7702092814	77-10	7702093873	36-01	7702124318	17-11

1	2	1	2	1	2	1	2	1	2
77022042224	69-01	77022047112	74-01	77022066040	62-351	77022083346	72-011	7703001020	55-01
77022042322	77-061	77022047113	74-01	77022066041	62-351	77022083347	72-011	7703001020	55-02
77022042333	77-061	77022047115	71-01	77022066045	10-40	77022083348	72-011	7703001074	13-03
77022042338	78-121	77022047116	71-01	77022066080	80-20	77022083349	72-011	7703001074	19-04
77022042339	78-121	77022047117	71-01	77022066081	80-20	77022083349	72-031	7703001118	11-40
77022042420	78-121	77022047119	71-01	77022066141	62-301	77022083422	72-031	7703001118	12-05
77022042421	78-121	77022047220	71-01	77022066142	62-301	77022083423	72-031	7703001118	12-10
77022043011	79-031	77022047221	71-01	77022066149	85-03	77022083424	72-031	7703001118	13-28
77022043022	79-031	77022047222	71-01	77022066159	10-40	77022083425	72-031	7703001118	13-30
77022043077	69-01	77022047334	77-101	77022066167	62-301	77022083426	72-031	7703001118	34-40
77022045336	72-15	77022047335	77-101	77022066168	62-301	77022083427	72-031	7703001120	11-20
77022045337	72-15	77022047336	77-061	77022066169	62-301	77022083428	72-031	7703001120	12-05
77022045338	58-401	77022047337	77-061	77022066172	62-301	77022083434	77-101	7703001120	12-10
77022045335	58-401	77022047338	77-101	77022066183	62-301	77022083435	77-101	7703001120	12-15
77022046336	58-401	77022047339	77-101	77022066184	62-301	77022083436	77-101	7703001120	13-28
77022046337	58-401	77022047340	77-061	77022066185	62-301	77022083437	77-101	7703001120	85-03
77022046338	58-401	77022047411	77-061	77022066186	62-301	77022083456	78-121	7703001122	10-70
77022046441	58-401	77022047442	77-061	77022066188	62-301	77022083457	78-121	7703001122	87-50
77022046442	71-01	77022047443	77-061	77022066189	60-251	77022083458	78-121	7703001123	11-20
77022046443	71-01	77022047444	77-061	77022066190	60-251	77022083459	78-121	7703001125	11-01
77022046444	71-01	77022047445	77-061	77022066191	60-251	77022083462	78-121	7703001125	11-40
77022046445	71-01	77022047446	78-101	77022066205	60-20	77022083463	78-121	7703001129	11-01
77022046446	71-10	77022047447	78-101	77022066207	60-201	77022083464	78-121	7703001132	11-01
77022046447	71-10	77022047448	78-101	77022066208	81-10	77022083465	78-121	7703001138	20-01
77022046448	71-10	77022047449	78-101	77022066209	81-10	77022083466	71-05	7703001142	17-11
77022046449	71-10	77022047478	78-121	77022066210	60-201	77022083467	71-05	7703001158	10-50
77022046450	71-10	77022047479	78-121	77022066213	42-10	77022083468	71-05	7703001158	12-01
77022046451	71-10	77022047480	78-121	77022066214	42-10	77022083469	71-05	7703001158	13-24
77022046452	71-10	77022047481	78-121	77022066215	43-01	77022083470	71-05	7703001158	13-24
77022046453	71-10	77022047482	78-121	77022066236	43-01	77022083471	77-061	7703001158	13-90
77022046454	71-01	77022047483	78-121	77022066235	16-15	77022083475	77-061	7703001158	13-90
77022046455	72-15	77022047484	78-121	77022066245	16-15	77022083496	77-061	7703001158	75-01
77022046456	72-15	77022047485	78-121	77022066246	35-01	77022083497	77-061	7703001160	13-80
77022046459	72-15	77022047486	78-121	77022066269	35-01	77022083498	78-121	7703001160	19-50
77022046460	72-031	77022047487	79-031	77022066270	12-111	77022083499	78-121	7703001162	36-10
77022046467	72-031	77022047489	79-031	77022066340	12-111	77022083500	78-121	7703001162	36-12
77022046468	72-031	77022047490	79-031	77022066341	12-111	77022083340	58-401	7702210972	78-102
77022046478	72-031	77022047495	72-01	77022066344	12-121	77022083341	72-011	7702210973	78-102
77022046479	72-031	77022047496	72-031	77022066344	12-121	77022083342	72-011	7702210974	78-102
77022046480	72-031	77022047497	72-031	77022066345	12-131	77022083343	72-011	7702210975	78-102
77022046481	72-031	77022047498	72-031	77022066345	12-131	77022083344	72-011	7702210976	13-04
77022046482	72-031	77022047499	72-031	77022066345	12-131	77022083345	72-011	7703001008	13-04
77022046483	72-031	77022047500	72-031	77022066346	12-131	77022083345	72-011	7703001008	13-04
77022046484	72-031	77022047501	72-031	77022066346	12-131	77022083345	72-011	7703001008	13-04
77022046485	72-031	77022047502	72-031	77022066346	12-131	77022083345	72-011	7703001008	13-04
77022046486	72-031	77022047503	72-031	77022066346	12-131	77022083345	72-011	7703001008	13-04
77022046487	72-031	77022047504	72-031	77022066346	12-131	77022083345	72-011	7703001008	13-04
77022046488	72-031	77022047505	72-031	77022066346	12-131	77022083345	72-011	7703001008	13-04
77022046489	72-031	77022047506	72-031	77022066346	12-131	77022083345	72-011	7703001008	13-04
77022046490	72-031	77022047507	72-031	77022066346	12-131	77022083345	72-011	7703001008	13-04
77022046491	72-031	77022047508	72-031	77022066346	12-131	77022083345	72-011	7703001008	13-04
77022046492	72-03	77022047509	74-01	77022066025	60-201	77022083345	72-011	7703001008	13-04
77022040997	72-01	77022047001	69-01	77022066021	60-201	77022083343	72-011	7702210975	78-102
77022041009	72-03	77022047008	74-01	77022066024	60-201	77022083344	72-011	7702210975	78-102
77022041010	72-03	77022047099	74-01	77022066025	60-201	77022083345	72-011	7702210975	78-102
77021243320	17-11	77022046886	58-401	77022048330	72-031	77022063347	12-131	7702210659	72-031
77021243325	17-11	77022046887	71-10	77022048331	72-031	77022063348	12-141	7702210659	77-102
77021243326	17-11	77022046888	71-10	77022048332	72-031	77022063349	12-141	7702210659	77-102
77021246776	17-11	77022046893	74-01	77022048315	10-20	77022063350	12-141	7702210971	77-102
77022040992	72-03	77022046898	69-01	77022066017	10-10	77022083340	58-401	7702210972	78-102
77022040993	72-03	77022046899	69-01	77022066018	10-10	77022083341	58-401	7702210973	78-102
77022040996	72-01	77022047000	69-01	77022066021	60-201	77022083342	72-011	7702210974	78-102
77022040997	72-01	77022047001	69-01	77022066022	60-201	77022083343	72-011	7702210975	78-102
77022041000	72-03	77022047008	74-01	77022066024	60-201	77022083344	72-011	7702210976	78-102
77022041010	72-03	77022047099	74-01	77022066025	60-201	77022083345	72-011	7703001008	13-04

1	2	1	2	1	2	1	2	1	2
7703001169	16-01	77030006103	55-02	7703016307	81-40	7703032047	12-01	7703034098	36-12
7703001186	10-40	7703006104	55-10	7703016314	55-15	7703032047	12-02	7703034104	31-01
7703001190	13-80	7703007039	85-15	7703016321	84-01	7703032047	13-24	7703034120	12-02
7703001194	34-10	7703007086	52-01	7703016336	74-01	7703032047	13-90	7703034120	13-90
7703001196	21-30	7703008001	43-01	7703016366	71-10	7703032049	12-05	7703035003	19-50
7703001243	38-20	7703008001	62-35	7703016390	72-15	7703032049	12-10	7703035003	36-30
7703001243	11-40	7703008027	84-01	7703016390	13-03	7703032083	85-03	7703035008	37-01
7703001333	46-10	7703008038	56-20	7703019012	82-01	7703032083	85-06	7703035008	55-20
7703001347	13-85	7703008038	56-21	7703019065	19-80	7703032083	85-18	7703037002	50-01
7703001347	16-01	7703008056	84-01	7703019085	31-01	7703032084	87-52	7703037003	17-05
7703001396	19-01	7703009117	12-15	7703019080	38-20	7703032101	13-80	7703037009	55-20
7703001440	36-10	7703009124	20-01	7703019085	19-01	7703033002	11-30	7703044008	50-40
7703001440	36-30	7703011065	55-15	7703019085	42-01	7703033005	86-20	7703044008	50-50
7703001498	32-10	7703015094	11-30	7703019086	76-02	7703033009	62-35	7703044087	19-50
7703001658	86-20	7703016007	55-20	7703019087	13-03	7703033009	62-35 ¹	7703044087	46-10
7703001667	11-40	7703016013	64-01	7703019087	19-30	7703033009	80-30	7703044087	52-01
7703001670	36-30	7703016017	57-01	7703019087	19-50	7703033015	62-35	7703044094	19-30
7703001693	36-12	7703016017	87-30	7703019087	19-50	7703033015	55-01	7703044094	41-30
7703001750	13-80	7703016022	84-01	7703019087	52-20	7703033016	55-02	7703044094	46-10
7703001750	16-01	7703016024	71-01	7703019087	76-02	7703033016	75-10	7703044097	42-01
7703001865	10-50	7703016024	86-30	7703019088	38-20	7703033016	75-15	7703046031	55-01
7703001865	11-30	7703016026	71-01	7703019090	46-10	7703033020	48-01	7703046031	55-02
7703001865	85-03	7703016030	50-30	7703019090	52-20	7703033022	81-01	7703046034	85-06
7703001878	85-06	7703016034	72-15	7703019091	19-80	7703033022	81-10	7703046048	85-03
7703001904	21-30	7703016046	72-15	7703019091	46-10	7703033024	80-01	7703046049	46-01
7703001904	48-01	7703016051	83-05	7703019093	32-01	7703033025	17-05	7703046052	72-15
7703001921	31-01	7703016078	58-30	7703019095	46-10	7703033027	11-30	7703046069	55-10
7703001943	38-01	7703016142	38-20	7703019099	52-01	7703033043	81-01	7703046069	57-01
7703001953	46-10	7703016142	55-10	7703019099	76-01	7703033043	81-10	7703046069	84-01
7703001953	13-90	7703016154	55-40	7703019099	76-02	7703033405	33-01	7703046080	46-10
7703001956	37-30	7703016154	58-30	7703019101	17-12	7703033405	32-10	7703046091	19-01
7703001992	75-10	7703016154	71-01	7703019103	36-30	7703034011	46-10	7703047007	44-01
7703001992	75-15	7703016256	81-20	7703019107	19-30	7703034014	32-01	7703050033	38-01
7703002001	38-01	7703016264	13-28	7703019107	46-10	7703034018	31-30	7703050054	38-01
7703002007	41-30	7703016264	46-01	7703019120	31-01	7703034019	19-80	7703050069	38-01
7703002008	21-20	7703016264	46-10	7703025004	75-10	7703034019	36-10	7703050070	38-01
7703002008	21-30	7703016264	55-01	7703025004	75-15	7703034020	31-30	7703050085	37-60
7703002010	21-20	7703016264	55-02	7703025012	75-15	7703034027	36-10	7703050094	38-01
7703002011	21-20	7703016278	57-01	7703025012	75-15	7703034027	36-30	7703050116	17-12
7703002050	19-50	7703016278	72-15	7703027048	12-01	7703034031	31-01	7703053011	48-01
7703004082	50-10	7703016285	56-35	7703027088	11-20	7703034037	36-12	7703053032	87-52
7703004082	50-15	7703016291	76-02	7703027092	12-01	7703034037	37-60	7703053036	20-01
7703004082	50-20	7703016298	87-40	7703027112	10-40	7703034037	38-20	7703053037	12-01
7703004092	84-10	7703016298	55-01	7703027114	11-20	7703034046	19-50	7703053037	12-02
7703004099	50-40	7703016298	55-02	7703027120	10-40	7703034061	31-01	7703053037	13-80
7703004109	50-50	7703016303	58-40	7703027167	12-02	7703034061	32-01	7703053037	16-01
7703004128	31-40	7703016303	58-40 ¹	7703027168	19-50	7703034068	31-40	7703053037	19-50
7703005065	50-01	7703016304	55-15	7703027187	21-30	7703034068	33-40	7703053071	31-01
7703006103	55-01	7703016304	55-40	7703027195	21-30	7703034082	21-45	7703053071	32-01
		7703016304	62-30	7703027215	13-35	7703034083	33-01	7703053105	37-01

1	2	1	2	1	2	1	2	1	2
7703053127	32-10	7703055011	87-50	7703066234	36-30	7703074078	64-01	7703077120	55-40
7703053127	76-01	7703055013	10-40	7703066257	37-01	7703074114	38-20	7703077133	71-01
7703053127	76-02	7703055013	13-80	7703066288	21-40	7703074121	59-51	7703077139	71-01
7703053142	36-10	7703055013	13-85	7703066288	21-45	7703074171	41-30	7703077151	55-40
7703053164	36-10	7703055013	36-12	7703066297	37-01	7703074177	50-01	7703077152	55-20
7703053230	33-40	7703055015	31-01	7703066313	11-40	7703074190	72-15	7703077170	55-20
7703053292	32-10	7703055022	12-15	7703066326	21-50	7703074191	64-01	7703077185	66-01
7703053294	21-30	7703055022	20-01	7703066327	21-50	7703074220	71-01	7703077202	57-01
7703053295	13-28	7703055031	37-40	7703066329	21-60	7703074222	71-01	7703077225	56-35
7703053295	13-30	7703055058	56-20	7703066329	21-65	7703074224	74-01	7703078060	19-20
7703053348	10-60	7703057021	37-01	7703066331	21-50	7703074226	74-01	7703078077	50-54
7703053370	10-50	7703058002	11-30	77030667008	50-01	7703074235	55-02	7703078077	50-55
7703053407	52-20	7703058034	16-01	77030667030	21-60	7703074235	55-10	7703078084	52-01
7703053431	36-12	7703058041	21-40	77030667030	21-65	7703074261	71-01	7703078086	48-01
7703053431	33-01	7703058045	19-50	77030667069	21-50	7703074263	55-01	7703078111	19-10
7703053445	38-20	7703058048	56-35	77030667079	12-01	7703074286	55-15	7703078113	11-30
7703053521	10-60	7703058064	21-30	77030667082	21-65	7703075009	10-40	7703078116	61-20
7703053541	21-50	7703058067	19-80	77030667093	50-01	7703075009	12-01	7703079043	17-12
7703053561	21-65	7703058079	75-10	77030667093	21-60	7703075033	21-20	7703079070	17-20
7703053605	21-65	7703058117	36-10	77030667137	21-60	7703075085	11-20	7703079072	19-20
7703053606	21-65	7703061007	19-20	77030667137	21-65	7703075091	10-40	7703079072	80-20
7703053674	36-10	7703061031	55-20	77030667175	48-01	7703075105	33-40	7703079094	37-60
7703055005	13-04	7703061090	10-80	77030667207	29-01	7703075135	10-50	7703079103	19-20
7703055005	16-05	7703061115	21-50	77030667257	53-01	7703075152	21-20	7703079105	17-05
7703055005	16-70	7703061115	38-20	77030667270	38-20	7703075152	21-30	7703079105	17-05
7703055007	12-05	7703061116	38-20	77030667271	38-20	7703076107	50-65	7703079116	37-20
7703055007	12-15	7703061121	38-20	77030667272	38-20	7703076107	50-70	7703079118	50-50
7703055007	13-28	7703061155	38-20	770306672099	10-60	7703076112	71-01	7703079131	13-81
7703055007	13-30	7703062001	12-02	770306672044	87-52	7703076115	72-03	7703079142	38-01
7703055007	16-15	7703062007	12-02	770306672046	55-15	7703076115	72-031	7703079145	17-05
7703055007	42-01	7703062011	10-50	770306672050	48-01	7703076131	87-50	7703079146	37-20
7703055007	61-01	7703065087	36-10	770306672050	81-20	7703076146	87-52	7703079156	37-12
7703055007	87-50	7703065087	36-12	770306672050	62-30	7703077007	55-20	7703079158	37-80
7703055007	87-52	7703065119	36-10	770306672050	62-351	7703077009	38-20	7703079214	50-40
7703055011	10-40	7703065120	62-35	770306672177	55-15	7703077021	38-20	7703079214	50-50
7703055011	10-50	7703065120	62-351	770306672181	42-10	7703077025	55-20	7703079214	50-50
7703055011	12-01	7703065121	62-35	770306672203	56-35	7703077060	75-15	7703079290	50-40
7703055011	12-05	7703065121	62-351	770306672209	72-15	7703077066	76-02	7703079290	50-50
7703055011	12-10	7703065122	62-35	770306672227	55-40	7703077068	71-05	7703079299	90-01
7703055011	13-01	770306651222	62-351	770306672230	55-40	7703077078	74-01	7703079317	38-01
7703055011	13-80	77030665128	21-50	770306673059	64-01	7703077080	36-30	7703080002	57-01
7703055011	13-85	77030665152	13-35	770306673105	13-03	7703077096	71-10	7703080026	55-15
7703055011	13-90	77030665185	29-10	770306673105	18-01	7703077107	71-10	7703080032	80-01
7703055011	16-01	77030666007	36-10	770306673105	38-20	7703077108	71-01	7703080036	86-20
7703055011	16-70	77030666035	33-40	770306673117	38-20	7703077109	71-01	7703080059	36-30
7703055011	19-30	77030666038	38-40	770306673181	13-03	7703077110	68-01	7703080059	36-30
7703055011	34-30	77030666083	29-20	770306673481	16-70	7703077111	72-01	7703081005	72-15
7703055011	34-32	77030666150	38-01	770306674035	64-01	7703077111	72-03	7703081015	72-15
7703055011	36-10	77030666151	38-01	770306674071	64-01	7703077111	72-031	7703081019	55-40
7703055011	36-12	77030666162	38-01	770306674073	64-01	7703077112	19-01	7703081019	71-01

1	2	1	2	1	2	1	2	1	2
7703081019	76-02	7703090313	33-40	7703101215	19-50	7704000851	57-01	7704001520	37-30
7703081024	55-15	7703090316	21-50	7703190092	19-30	7704000863	57-01	7704001548	64-01
7703081028	38-20	7703090323	21-40	7704000008	61-20	7704000878	55-40	7704001557	54-01
7703081028	56-35	7703090323	21-45	7704000008	86-01	7704000879	55-40	7704001566	71-01
7703081029	78-10	7703090324	21-50	7704000014	86-01	7704000926	36-10	7704001592	37-80
7703081029	78-11	7703090329	21-40	7704000065	86-01	7704001041	57-01	7704001604	13-81
7703081029	78-12	7703090329	21-45	7704000179	21-20	7704001043	57-01	7704001606	19-10
7703081049	55-40	7703090334	21-45	7704000287	11-20	7704001075	57-30	7704001633	31-01
7703081050	71-05	7703090338	21-40	7704000335	66-01	7704001077	36-40	7704001634	31-01
7703081051	71-05	7703090338	21-45	7704000446	21-40	7704001164	57-30	7704001657	55-20
7703081054	68-01	7703090339	21-45	7704000446	21-45	7704001164	58-30	7704001660	32-01
7703081056	61-01	7703090381	21-40	7704000461	86-30	7704001166	58-30	7704001666	13-03
7703081064	55-40	7703090382	21-45	7704000470	10-50	7704001197	72-15	7704001698	13-30
7703081064	61-01	7703090391	21-45	7704000471	10-50	7704001198	72-15	7704001718	11-40
7703081073	55-20	7703090417	21-50	7704000587	54-01	7704001198	72-15	7704001746	50-55
7703082013	11-40	7703097176	81-50	7704000588	54-01	7704001200	72-15	7704001747	66-01
7703082015	10-40	7703097178	81-50	7704000589	54-01	7704001201	72-15	7704001767	64-01
7703083029	19-50	7703097179	81-50	7704000590	54-01	7704001202	72-15	7704001768	64-01
7703083029	19-50	7703097181	81-50	7704000591	54-01	7704001203	72-15	7704001769	87-30
7703083219	13-35	7703097182	81-50	7704000592	54-01	7704001207	50-70	7704001779	35-01
7703084016	36-30	7703097183	81-50	7704000593	54-01	7704001213	35-01	7704001815	36-40
7703085024	36-10	7703097184	81-50	7704000594	54-01	7704001218	50-70	7704001862	50-01
7703087080	10-40	7703097185	81-50	7704000595	54-01	7704001256	58-40	7704001870	55-02
7703087097	11-30	7703097387	81-50	7704000596	54-01	7704001257	58-40	7704001970	55-10
7703087114	21-50	7703101006	50-54	7704000597	54-01	7704001268	32-01	7704001971	55-10
7703087115	21-60	7703101006	50-55	7704000599	54-01	7704001271	62-35	7704001972	55-10
7703087115	21-65	7703101034	76-01	7704000600	54-01	7704001271	54-01	7704001982	55-02
7703087138	21-50	7703101034	76-02	7704000601	54-01	7704001309	13-28	7704001983	55-02
7703087146	21-50	7703101042	13-81	7704000602	54-01	7704001309	38-20	7704001983	55-02
7703087163	21-60	7703101042	61-01	7704000603	54-01	7704001310	38-20	7704002006	48-01
7703087163	21-65	7703101043	83-08	7704000604	54-01	7704001313	50-55	7704002009	58-40
7703088017	57-01	7703101043	19-80	7704000605	54-01	7704001313	50-55	7704002011	32-01
7703088033	13-24	7703101046	13-80	7704000606	54-01	7704001315	50-70	7704002027	55-40
7703088046	43-01	7703101046	13-85	7704000607	54-01	7704001315	50-55	7704002028	55-40
7703088048	64-01	7703101052	32-10	7704000608	54-01	7704001315	50-55	7704002029	55-40
7703088048	74-01	7703101055	16-01	7704000609	54-01	7704001319	50-70	7704002034	36-40
7703088055	41-30	7703101055	34-10	7704000610	54-01	7704001319	19-80	7704002037	36-40
7703088055	64-01	7703101058	13-80	7704000617	54-01	7704001320	19-80	7704002067	50-50
7703088063	74-01	7703101076	32-10	7704000621	54-01	7704001334	21-30	7704002068	50-50
7703090215	21-60	7703101120	36-12	7704000646	32-01	7704001372	13-28	7704002082	57-01
7703090215	21-65	7703101145	31-01	7704000674	33-01	7704001372	13-30	7704002215	86-01
7703090253	33-40	7703101147	10-60	7704000681	31-01	7704001415	66-01	7704002236	86-01
7703090278	21-45	7703101157	13-85	7704000715	19-10	7704001430	20-01	7704002238	12-15
7703090280	21-50	7703101168	33-01	7704000794	50-54	7704001432	13-81	7704002239	12-15
7703090282	21-40	7703101172	10-40	7704000794	50-55	7704001449	65-01	7704002292	32-01
7703090282	21-45	7703101196	38-20	7704000794	50-60	7704001459	55-40	7704002363	58-40
7703090283	31-40	7703101197	36-10	7704000795	50-65	7704001460	55-40	7704002364	58-40
7703090297	10-70	7703101199	36-10	7704000795	50-70	7704001506	37-20	7704002415	21-20
7703090312	21-45	7703101207	36-12	7704000796	65-01	7704001509	37-30	7704002483	64-01
				7704000822	65-01	7704001510	37-30	7704002587	50-01